



US00D546898S

(12) **United States Design Patent**  
**Cooper**

(10) **Patent No.:** **US D546,898 S**

(45) **Date of Patent:** **\*\* Jul. 17, 2007**

(54) **RATTLING HOCKEY STICK NOISEMAKER**

(76) Inventor: **Gary Cooper**, 331 Knipp Forest,  
Houston, TX (US) 77024

(\*\*) Term: **14 Years**

(21) Appl. No.: **29/252,764**

(22) Filed: **Jan. 26, 2006**

(51) **LOC (8) Cl.** ..... **21-01**

(52) **U.S. Cl.** ..... **D21/406; D21/405**

(58) **Field of Classification Search** ..... D21/40,  
D21/405, 406, 722, 727; D3/200, 211; D11/44,  
D11/81; D19/42; D20/29, 42; 446/418-422,  
446/84; 84/402-420; 473/560-563  
See application file for complete search history.

(56) **References Cited**

**U.S. PATENT DOCUMENTS**

D151,599 S 11/1948 Colm  
D151,600 S 11/1948 Colm

(Continued)

**FOREIGN PATENT DOCUMENTS**

CA 2390294 A1 \* 12/2003

(Continued)

*Primary Examiner*—Catherine Tuttle

(74) *Attorney, Agent, or Firm*—Fulbright & Jaworski LLP

(57) **CLAIM**

The ornamental design for a rattling hockey stick noise-  
maker, as shown and described.

**DESCRIPTION**

The design is used as a noisemaker and souvenir for sporting  
events; One embodiment includes an eyelet providing for  
the addition of a carrying strap.

FIG. 1 shows an isometric view of a first embodiment of the  
rattling hockey stick noisemaker, which excludes the eyelet  
that is shown in phantom lines for illustrative purposes;

FIG. 2 shows a front elevation view of the rattling hockey  
stick noisemaker of FIG. 1;

FIG. 3 shows a view of the rattling hockey stick noisemaker  
of FIG. 1 looking down on the rattling hockey stick noise-  
maker from above, when positioned as shown in FIG. 4;

FIG. 4 shows a left side elevation view of the rattling hockey  
stick noisemaker of FIG. 1;

FIG. 5 shows a right elevation side view of the rattling  
hockey stick noisemaker of FIG. 1;

FIG. 6 shows a back elevation view of the rattling hockey  
stick noisemaker of FIG. 1;

FIG. 7 shows a view of the rattling hockey stick noisemaker  
of FIG. 1 looking up at the rattling hockey stick noisemaker  
from underneath, when positioned as shown in FIG. 5.

FIG. 8 shows an isometric view of an alternate embodiment  
of the rattling hockey stick noisemaker, which includes the  
eyelet;

FIG. 9 shows a front elevation view of the rattling hockey  
stick noisemaker of FIG. 8;

FIG. 10 shows a view of the rattling hockey stick noise-  
maker of FIG. 8 looking down on the rattling hockey stick  
noisemaker from above, when positioned as shown in FIG.  
11;

FIG. 11 shows a left side elevation view of the rattling  
hockey stick noisemaker of FIG. 8;

FIG. 12 shows a right elevation side view of the rattling  
hockey stick noisemaker of FIG. 8;

FIG. 13 shows a back elevation view of the rattling hockey  
stick noisemaker of FIG. 8; and,

FIG. 14 shows a view of the rattling hockey stick noise-  
maker of FIG. 8 looking up at the rattling hockey stick  
noisemaker from underneath, when positioned as shown in  
FIG. 12.

**1 Claim, 6 Drawing Sheets**

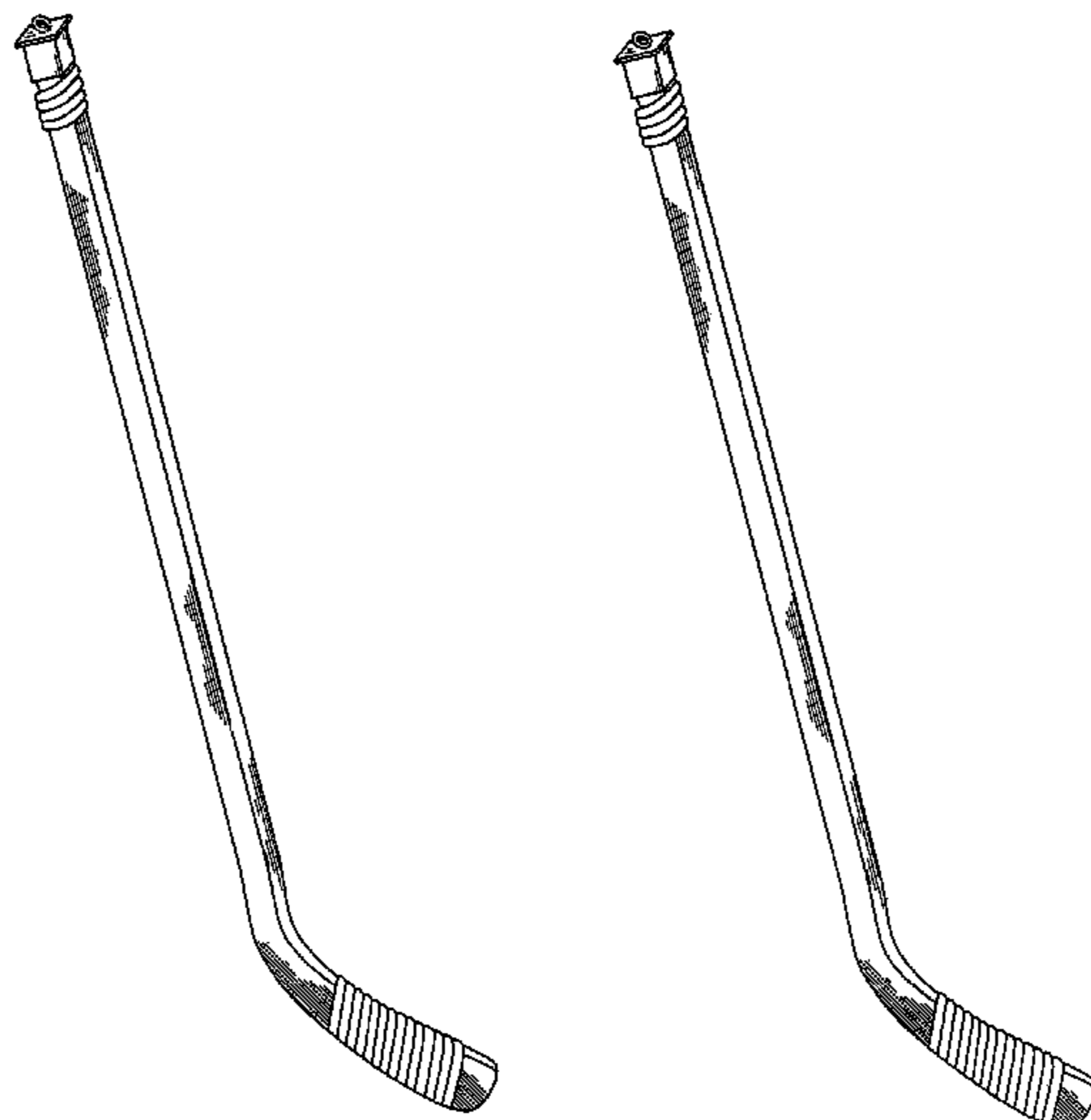

# US D546,898 S

Page 2

## U.S. PATENT DOCUMENTS

2,957,208 A \* 10/1960 Gardner et al. .... 264/46.4  
4,086,115 A \* 4/1978 Sweet et al. .... 156/178  
4,361,325 A \* 11/1982 Jansen ..... 473/562  
4,454,204 A 6/1984 Posey  
4,749,189 A \* 6/1988 Frank ..... 482/129  
5,044,250 A 9/1991 Beyer  
D323,861 S 2/1992 Cooper  
5,133,551 A 7/1992 Handy et al.  
5,161,798 A 11/1992 Orbanes et al.  
5,179,255 A 1/1993 Yeh  
5,219,162 A 6/1993 Orbanes et al.  
5,263,711 A \* 11/1993 Addis et al. .... 473/562  
5,265,514 A 11/1993 Schertz  
5,447,306 A \* 9/1995 Selden ..... 473/562  
5,451,047 A 9/1995 Liu  
D364,653 S 11/1995 Boden  
D364,654 S 11/1995 Boden  
D390,102 S \* 2/1998 Drew ..... D9/668  
D394,686 S 5/1998 Krzystofczyk  
5,913,709 A 6/1999 Cyr et al.  
5,928,057 A 7/1999 Teczynski  
5,980,404 A \* 11/1999 Gentile ..... 473/560  
D422,022 S \* 3/2000 Nussinow et al. .... D19/42  
6,033,327 A \* 3/2000 Bird ..... 473/560  
6,346,664 B1 2/2002 Shuen

6,365,810 B1 4/2002 Enhoffer et al.  
6,464,558 B1 10/2002 Ayres  
6,682,393 B1 1/2004 Puett, III  
6,736,695 B1 5/2004 Hoch  
D492,375 S \* 6/2004 Berghash et al. .... D21/727  
6,817,922 B1 11/2004 Davies  
6,834,610 B2 12/2004 Beaham, III  
D504,163 S 4/2005 Williams-Nicholas  
D508,092 S 8/2005 Williams-Nicholas  
D509,857 S 9/2005 Monson  
2001/0034177 A1 10/2001 Hunn  
2002/0177497 A1 \* 11/2002 Westerlund ..... 473/563  
2004/0009735 A1 1/2004 Puett  
2004/0147201 A1 7/2004 Cohen  
2005/0176343 A1 8/2005 Szekely  
2005/0187045 A1 \* 8/2005 Berghash ..... 473/560  
2005/0288132 A1 \* 12/2005 Hayden et al. .... 473/513  
2006/0063619 A1 \* 3/2006 Flaum ..... 473/560

## FOREIGN PATENT DOCUMENTS

DE 3344781 A1 \* 6/1984  
JP 2004321729 11/2004  
JP 2005102855 4/2005  
WO WO2005015542 2/2005

\* cited by examiner

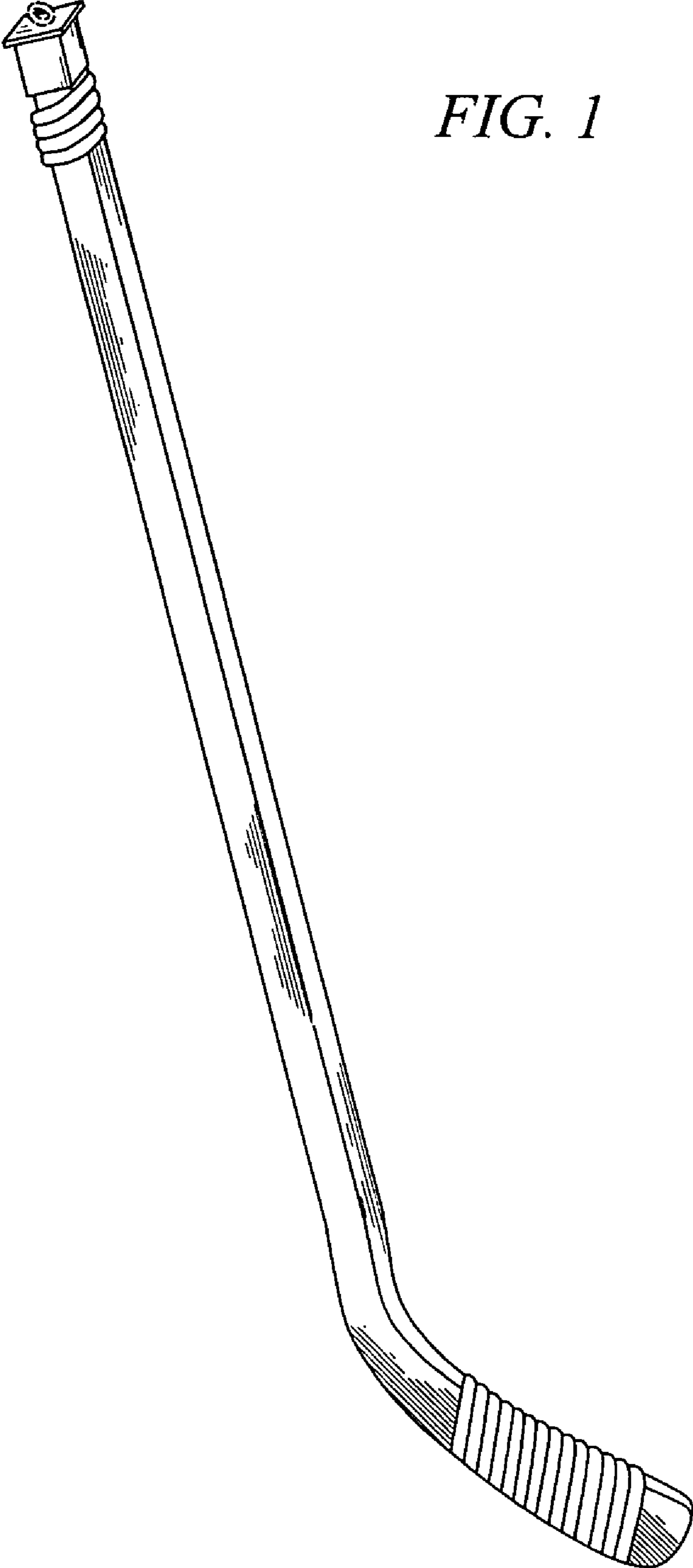

*FIG. 1*

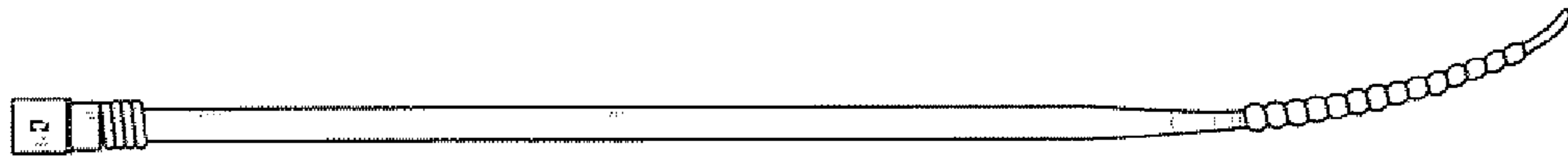

FIG. 3

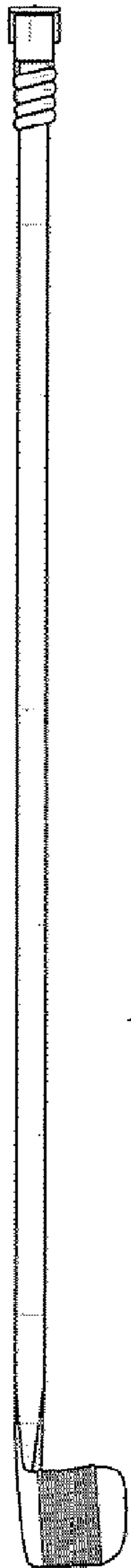

FIG. 2

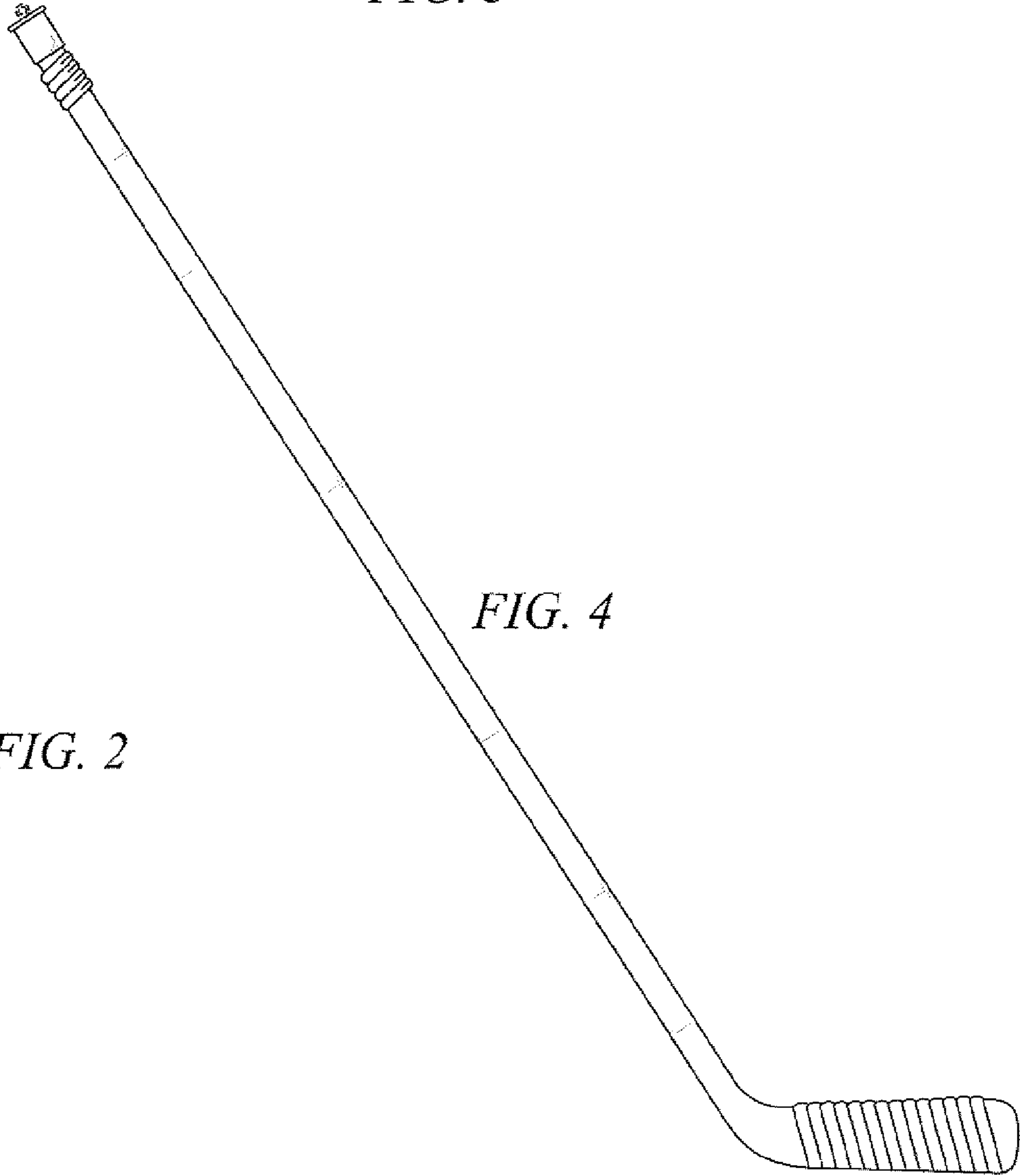
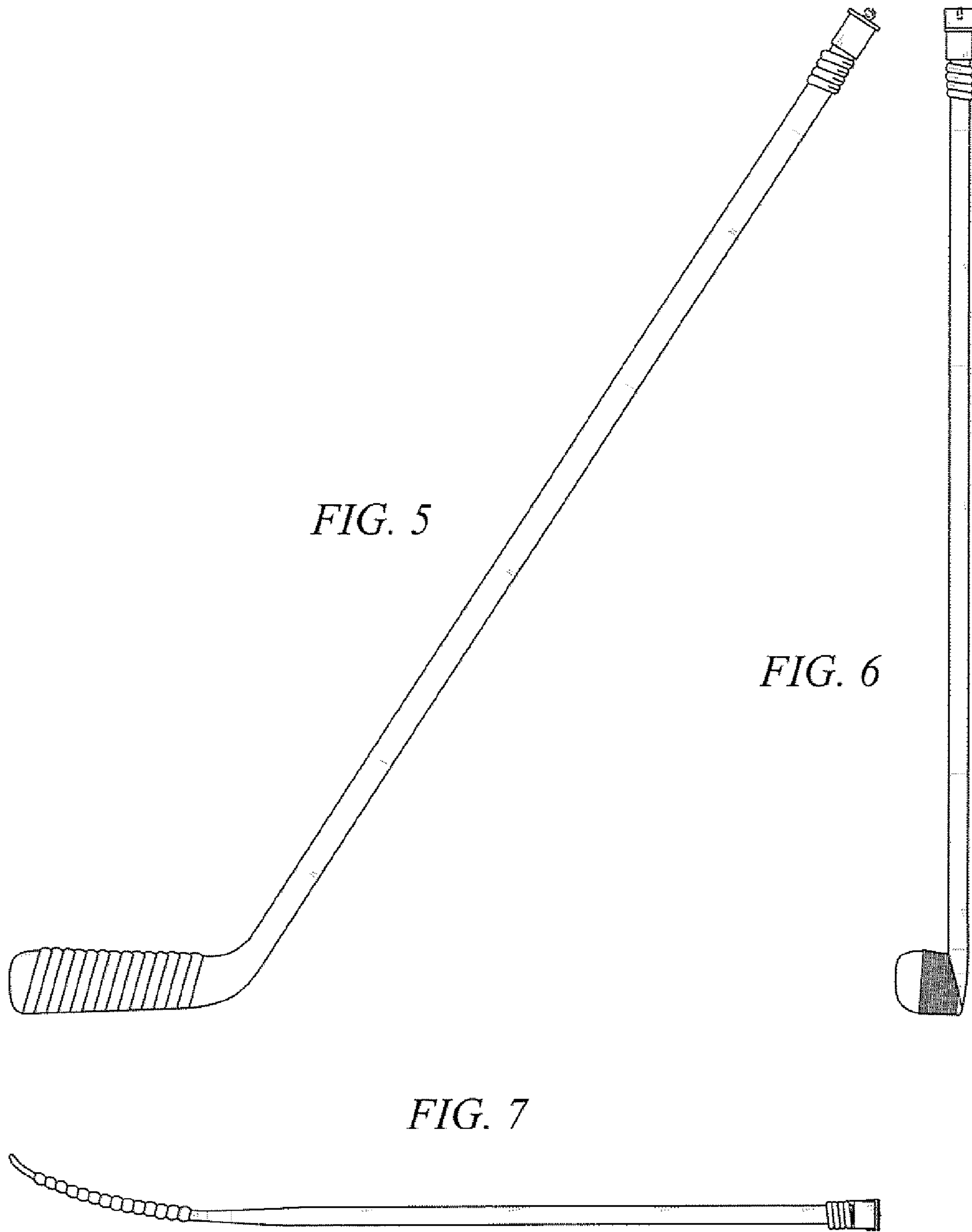
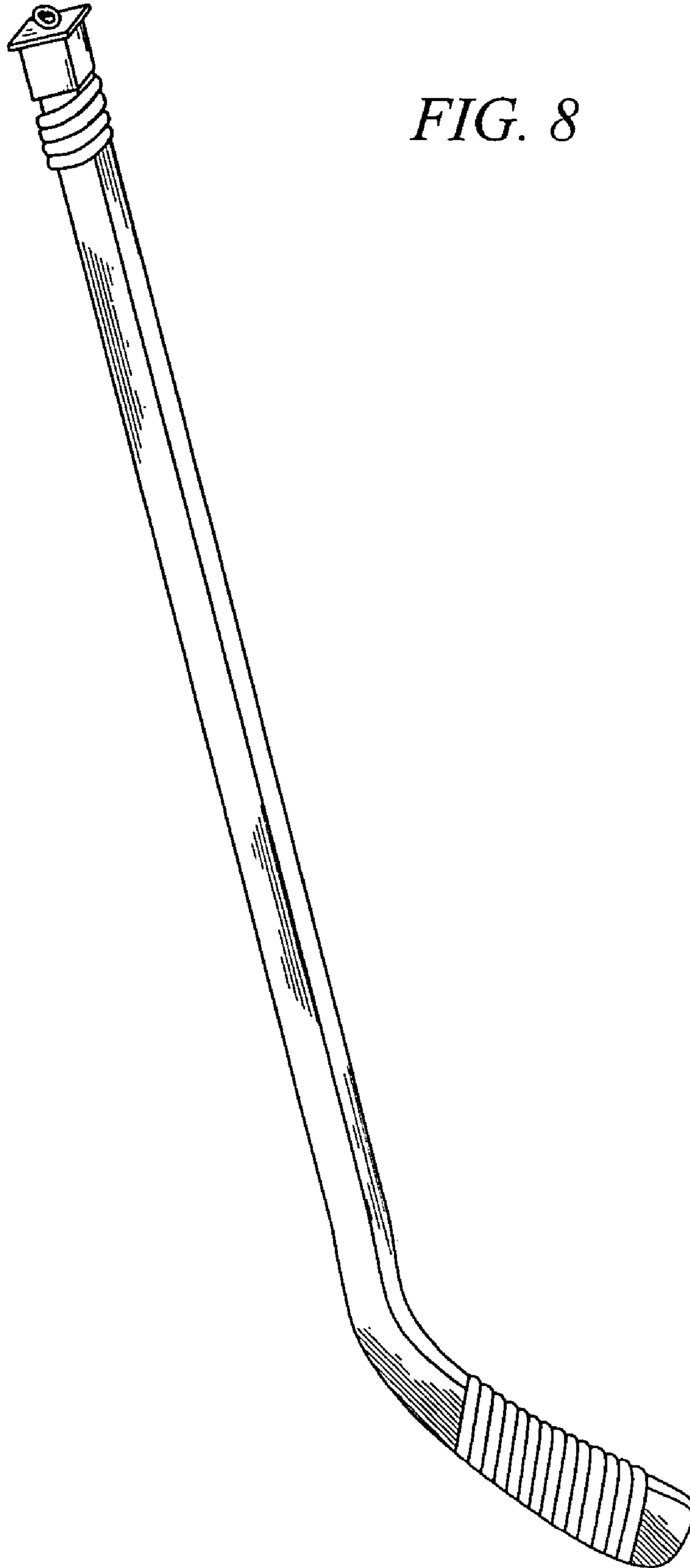

FIG. 4





*FIG. 8*



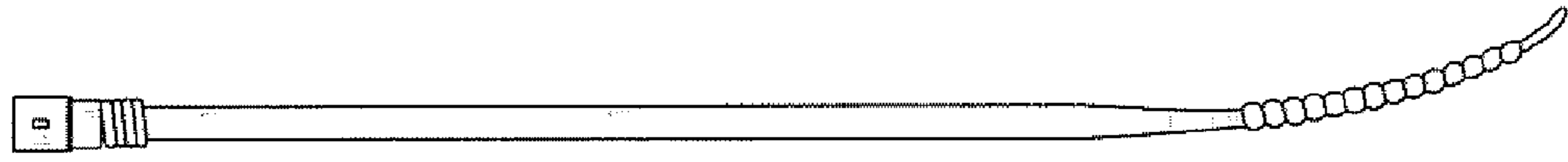

FIG. 10

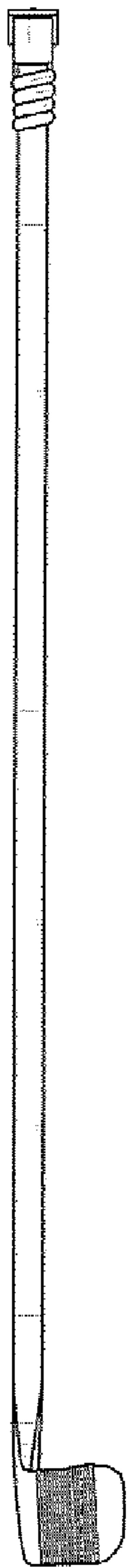

FIG. 9

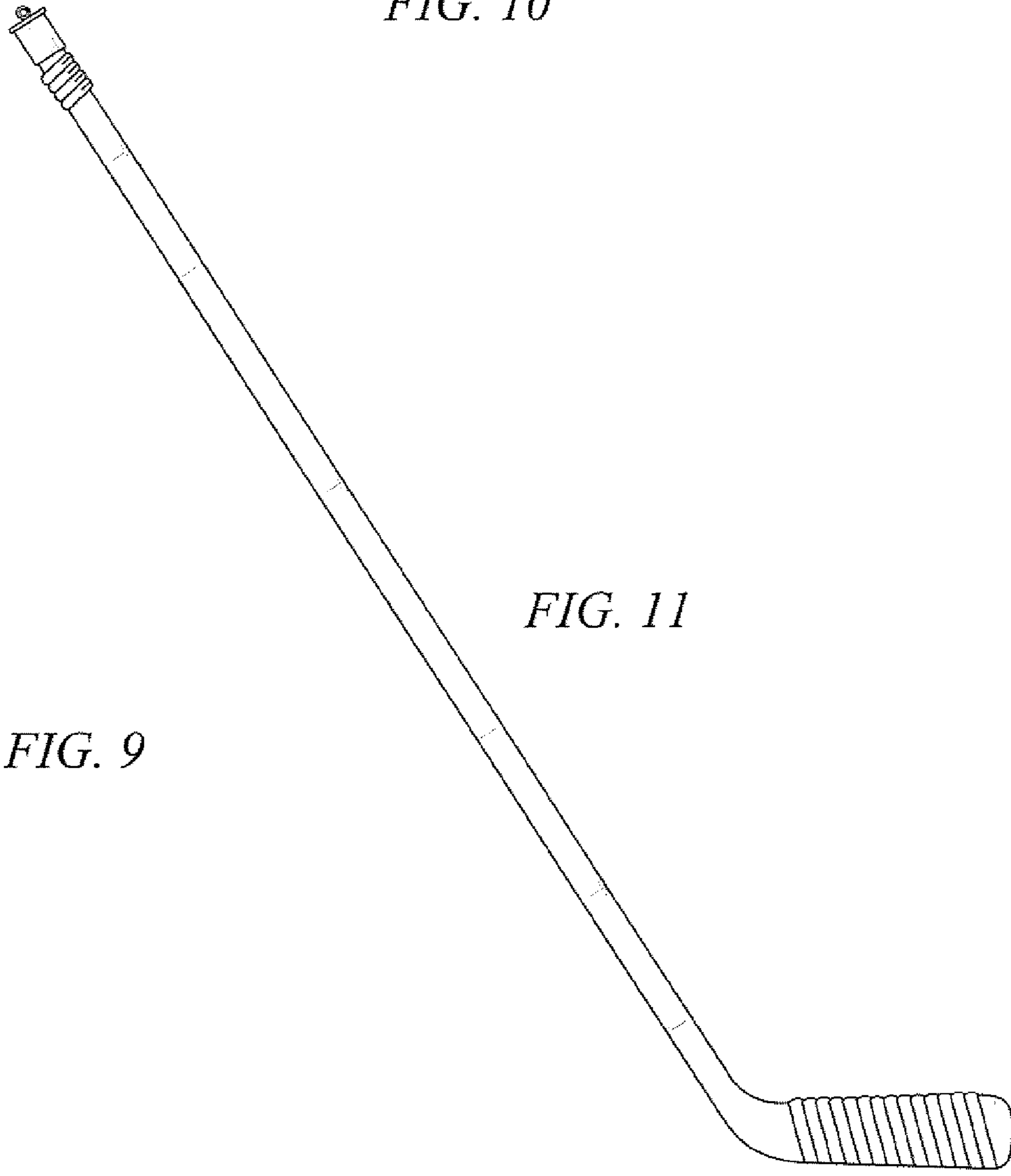

FIG. 11

