

US00D546853S

(12) **United States Design Patent**
Gaines et al.

(10) **Patent No.:** **US D546,853 S**

(45) **Date of Patent:** **** Jul. 17, 2007**

(54) **LAMINATING MACHINE**

2002/0117266 A1 8/2002 Han
2005/0247405 A1* 11/2005 Murphy et al. 156/555

(75) Inventors: **Ervin Gaines**, Crown Point, IN (US);
Chang-chih Wu, Taipei (TW)

OTHER PUBLICATIONS

(73) Assignee: **General Binding Corporation**,
Northbrook, IL (US)

AccuCut® 2003 Education Catalog, p. 24, © 2003.
AccuCut® 2002 Education Catalog, p. 31, © 2001.
AccuCut® 2001 Education Catalog, p. 25, © 2001.
AccuCut® 2000 Education Catalog, p. 34, © 1999.

(**) Term: **14 Years**

* cited by examiner

(21) Appl. No.: **29/235,741**

Primary Examiner—Antoine D. Davis

Assistant Examiner—Patricia Palasik

(22) Filed: **Aug. 5, 2005**

(74) *Attorney, Agent, or Firm*—Michael Best & Friedrich
LLP

(51) **LOC (8) Cl.** **15-99**

(52) **U.S. Cl.** **D15/146**

(58) **Field of Classification Search** D15/145,
D15/146; 100/155 R, 160, 176; 156/555,
156/560, 582, 583.1

(57) **CLAIM**

See application file for complete search history.

The ornamental design for a laminating machine, as shown
and described.

(56) **References Cited**

DESCRIPTION

U.S. PATENT DOCUMENTS

D342,271 S	12/1993	Keng	
D345,986 S	4/1994	Lim	
D353,604 S	12/1994	Prokop et al.	
D354,966 S	1/1995	Lim	
D354,967 S	1/1995	Lim	
D358,825 S	5/1995	Kuhns	
D358,826 S	5/1995	Kuhns	
D366,883 S	2/1996	Reinders	
6,131,636 A *	10/2000	Anderson et al.	156/555
D440,992 S	4/2001	Parson et al.	
D441,774 S	5/2001	Cheng	
D441,775 S	5/2001	Cheng	
D442,199 S	5/2001	Cheng	
D442,980 S	5/2001	Johnson et al.	
D443,883 S *	6/2001	Reuter	D15/146
D453,171 S	1/2002	Cheng	
D453,172 S	1/2002	Cheng	
D454,895 S *	3/2002	Sakata et al.	D15/146
D512,734 S *	12/2005	Messina et al.	D15/146
D534,192 S *	12/2006	Kiple et al.	D15/145

FIG. 1 is a perspective view taken from the top, front, and
right side of a laminating machine showing our new design;

FIG. 2 is a top plan view of the laminating machine shown
in FIG. 1;

FIG. 3 is a bottom view of the laminating machine shown in
FIG. 1;

FIG. 4 is a front elevational view of the laminating machine
shown in FIG. 1;

FIG. 5 is a rear elevational view of the laminating machine
shown in FIG. 1;

FIG. 6 is a left elevational side view of the laminating
machine shown in FIG. 1;

FIG. 7 is a right elevational side view of the laminating
machine shown in FIG. 1;

FIG. 8 is an enlarged fragmentary cross-sectional view taken
through line 8-8 of the laminating machine of FIG. 1;

FIG. 9 is an enlarged fragmentary cross-sectional view taken
through line 9-9 of the laminating machine of FIG. 1;

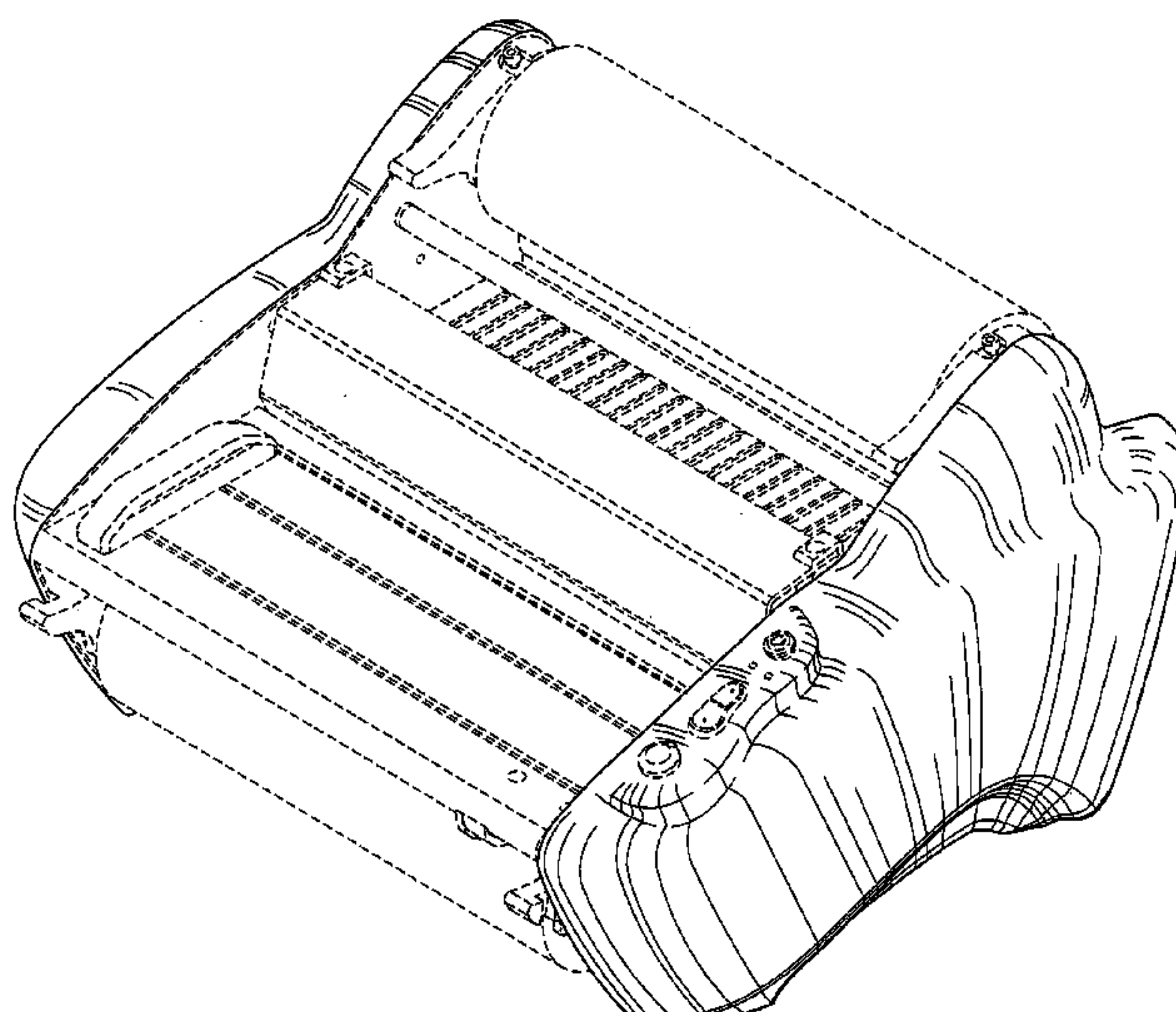

FIG. 10 is an enlarged fragmentary cross-sectional view taken through line 10-10 of the laminating machine of FIG. 1;

FIG. 11 is an enlarged fragmentary cross-sectional view taken through line 11-11 of the laminating machine of FIG. 1;

FIG. 12 is an enlarged fragmentary cross-sectional view taken through line 12-12 of the laminating machine of FIG. 1;

FIG. 13 is an enlarged fragmentary cross-sectional view taken through line 13-13 of the laminating machine of FIG. 1;

FIG. 14 is a perspective view taken from the top, front, and right side of another embodiment of a laminating machine showing our new design;

FIG. 15 is a top plan view of the laminating machine shown in FIG. 14;

FIG. 16 is a bottom view of the laminating machine shown in FIG. 14;

FIG. 17 is a front elevational view of the laminating machine shown in FIG. 14;

FIG. 18 is a rear elevational view of the laminating machine shown in FIG. 14;

FIG. 19 is a left elevational side view of the laminating machine shown in FIG. 14;

FIG. 20 is a right elevational side view of the laminating machine shown in FIG. 14;

FIG. 21 is an enlarged fragmentary cross-sectional view taken through line 21-21 of the laminating machine of FIG. 14;

FIG. 22 is an enlarged fragmentary cross-sectional view taken through line 22-22 of the laminating machine of FIG. 14;

FIG. 23 is an enlarged fragmentary cross-sectional view taken through line 23-23 of the laminating machine of FIG. 14;

FIG. 24 is an enlarged fragmentary cross-sectional view taken through line 24-24 of the laminating machine of FIG. 14;

FIG. 25 is an enlarged fragmentary cross-sectional view taken through line 25-25 of the laminating machine of FIG. 14; and,

FIG. 26 is an enlarged fragmentary cross-sectional view taken through line 26-26 of the laminating machine of FIG. 14.

The cross-sectional views are intended to show external contours of the claimed design. Any interior features shown in the cross-sectional views form no part of the claimed design.

The broken lines are for illustration purposes only and form no part of the claimed design.

1 Claim, 20 Drawing Sheets

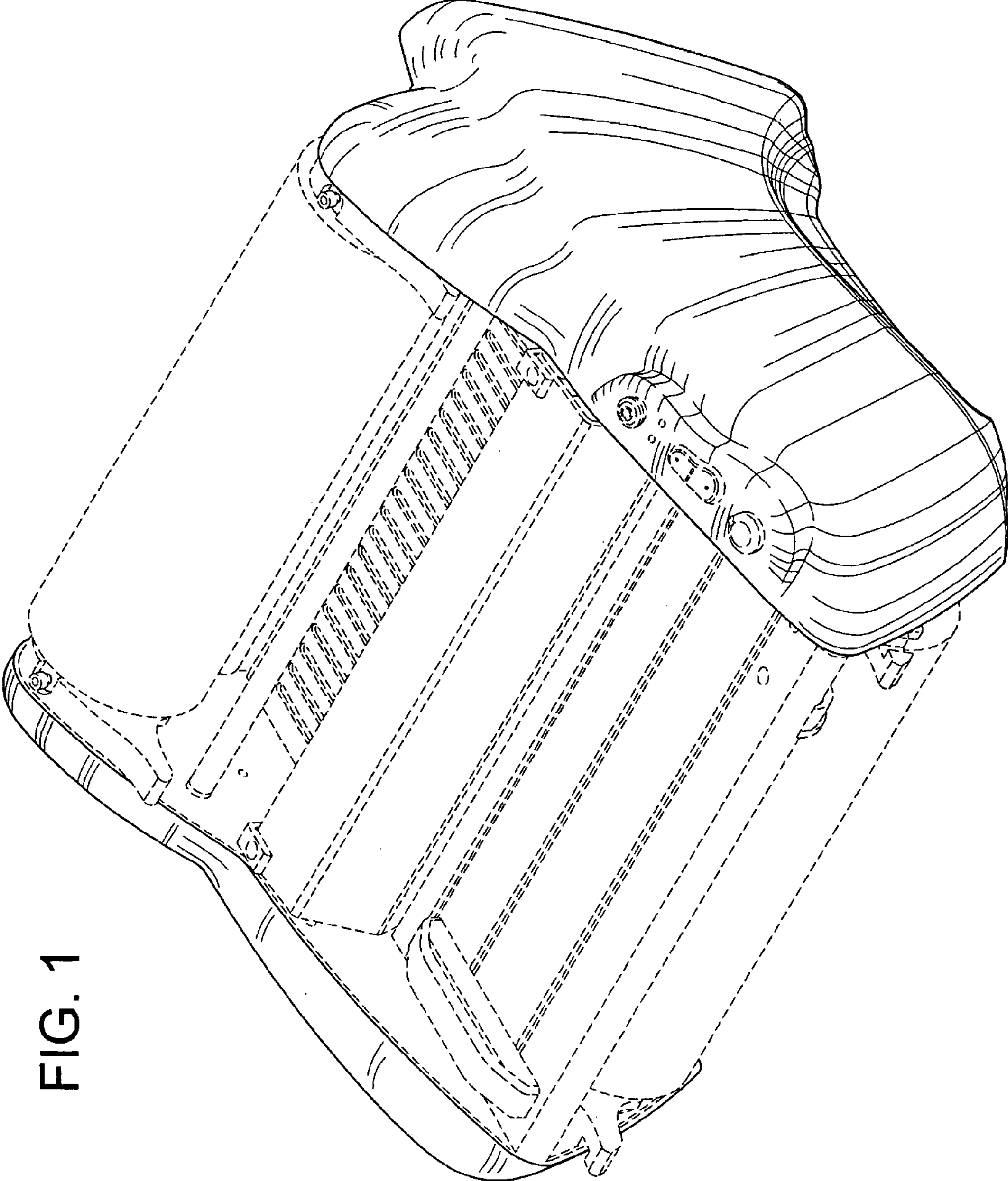

FIG. 1

FIG. 2

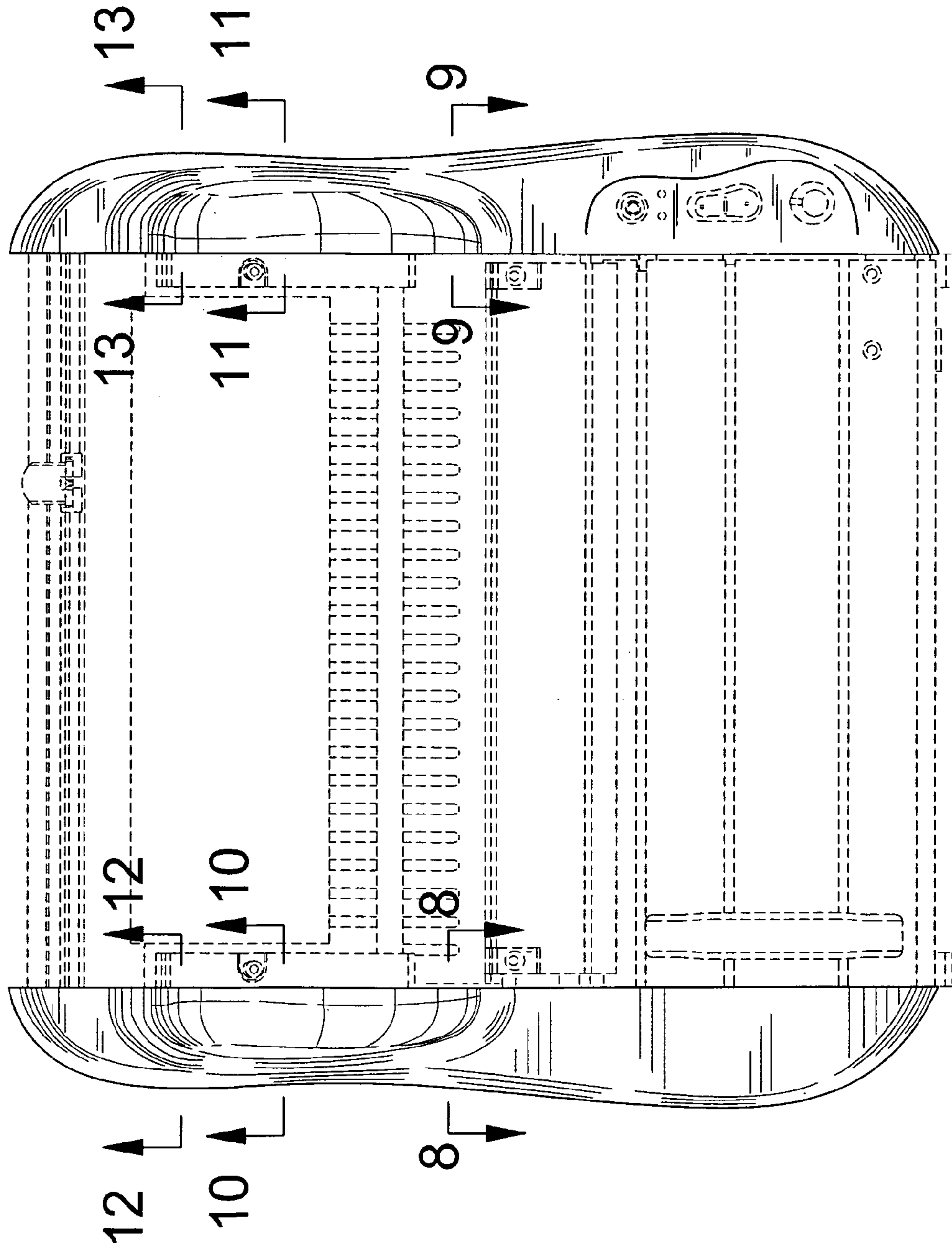
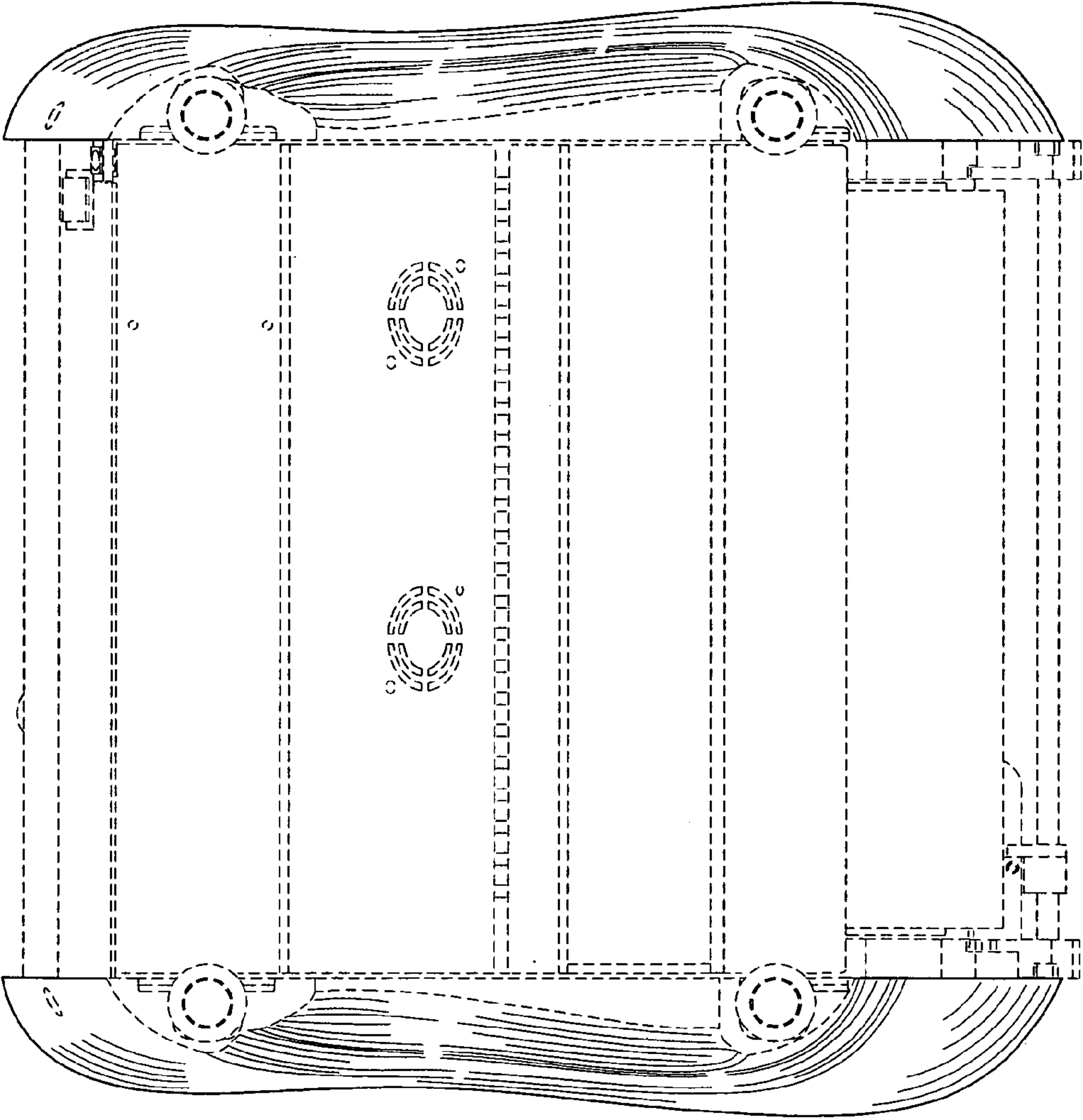

FIG. 3



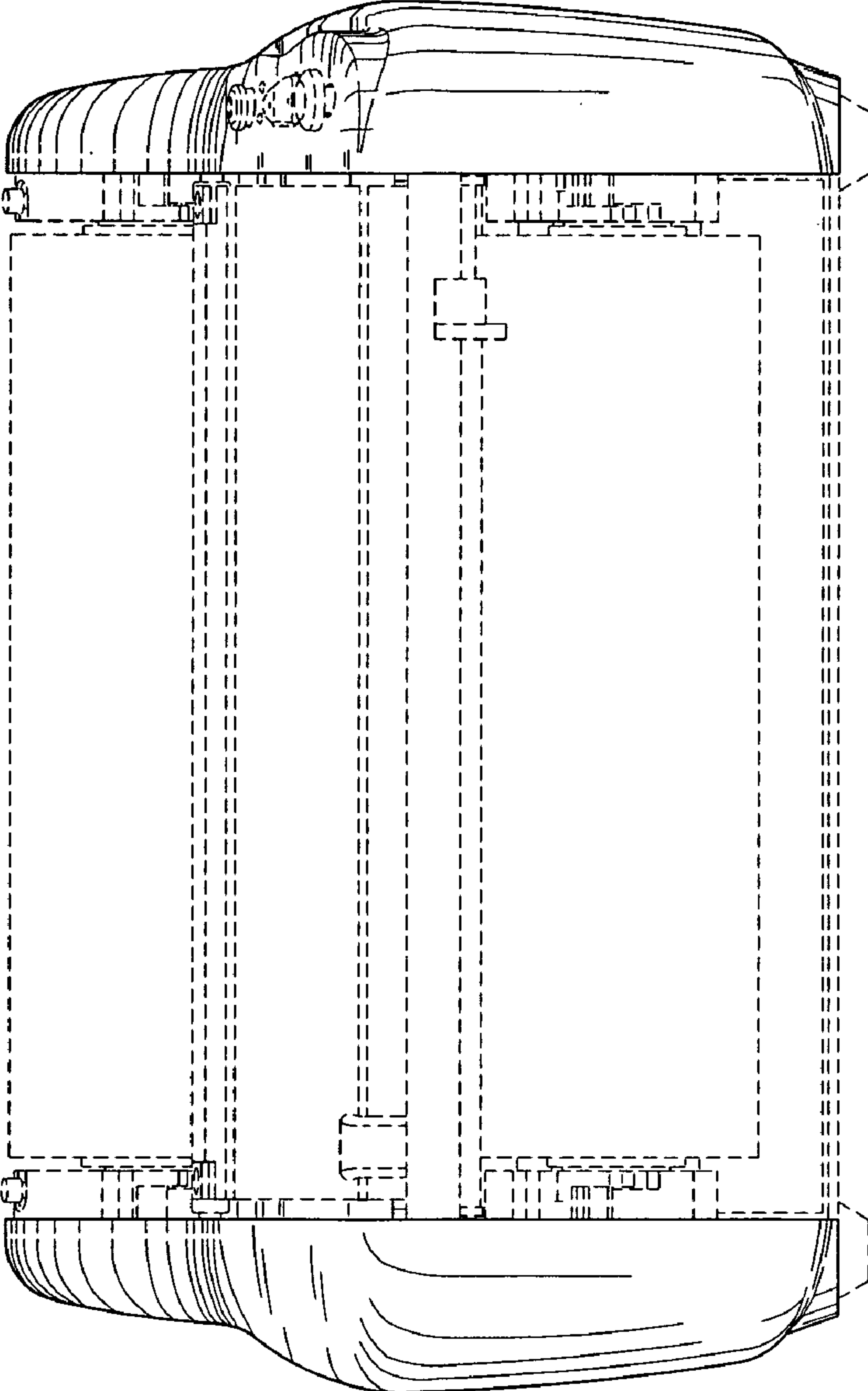
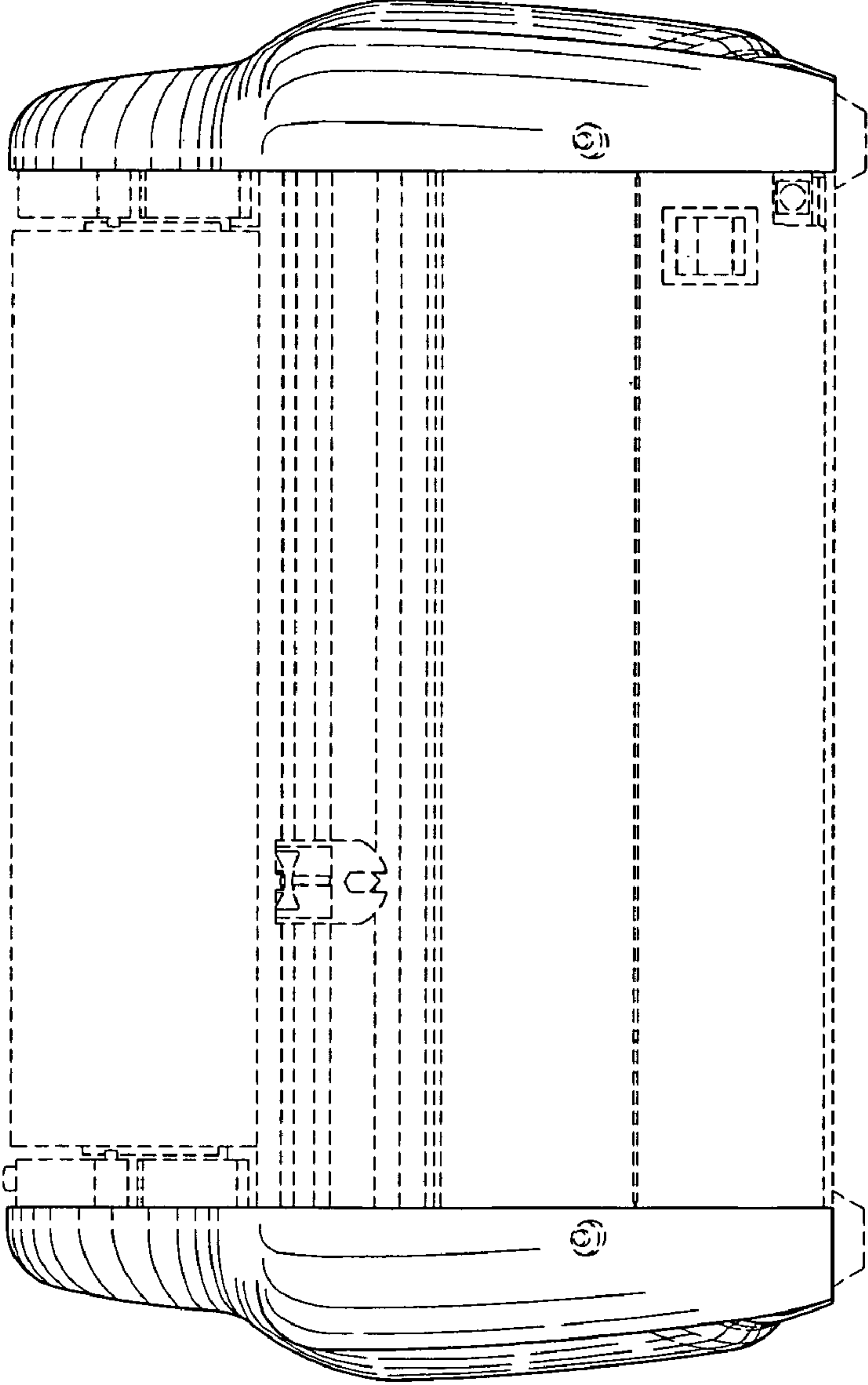

FIG. 4

FIG. 5



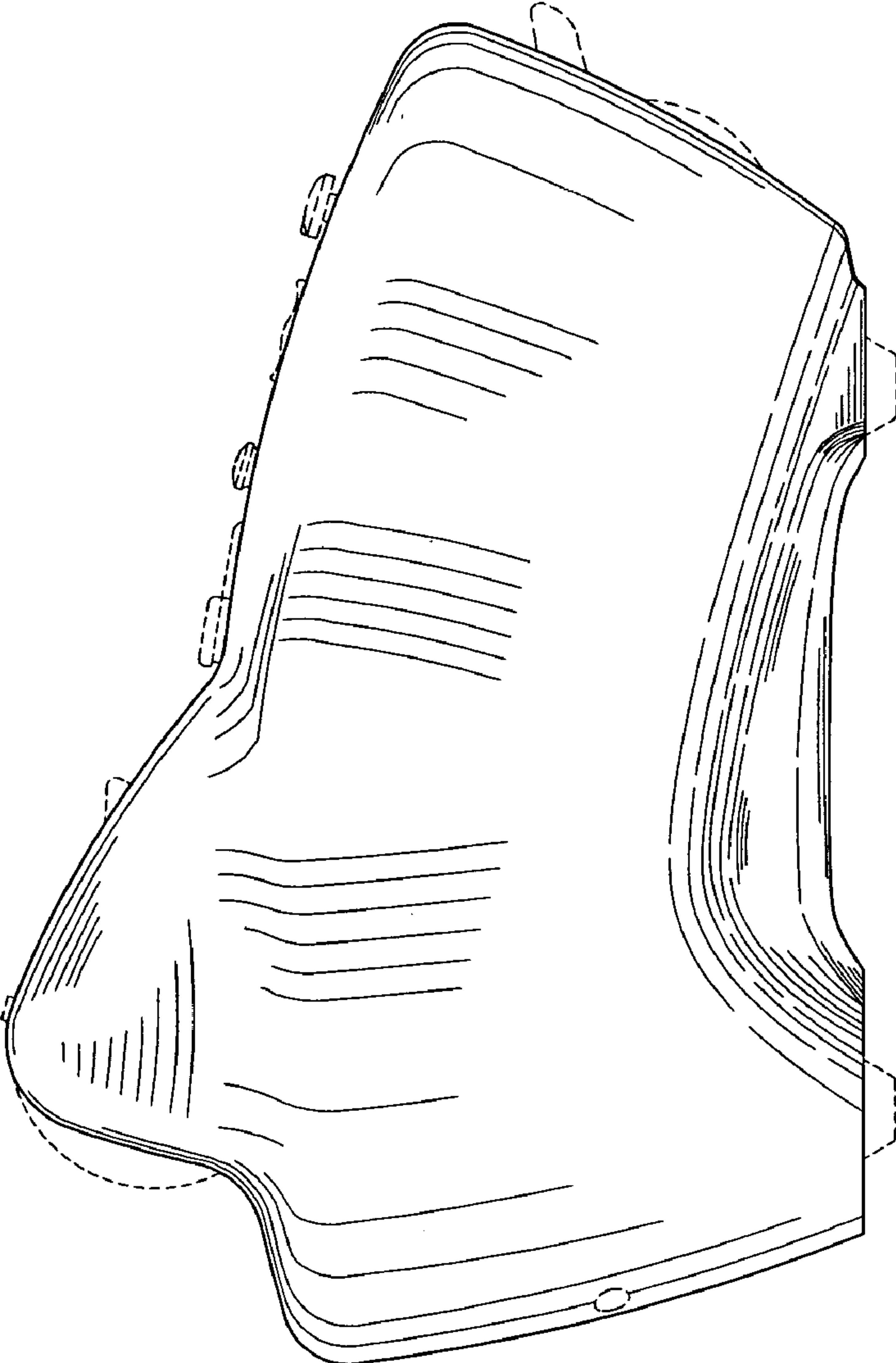
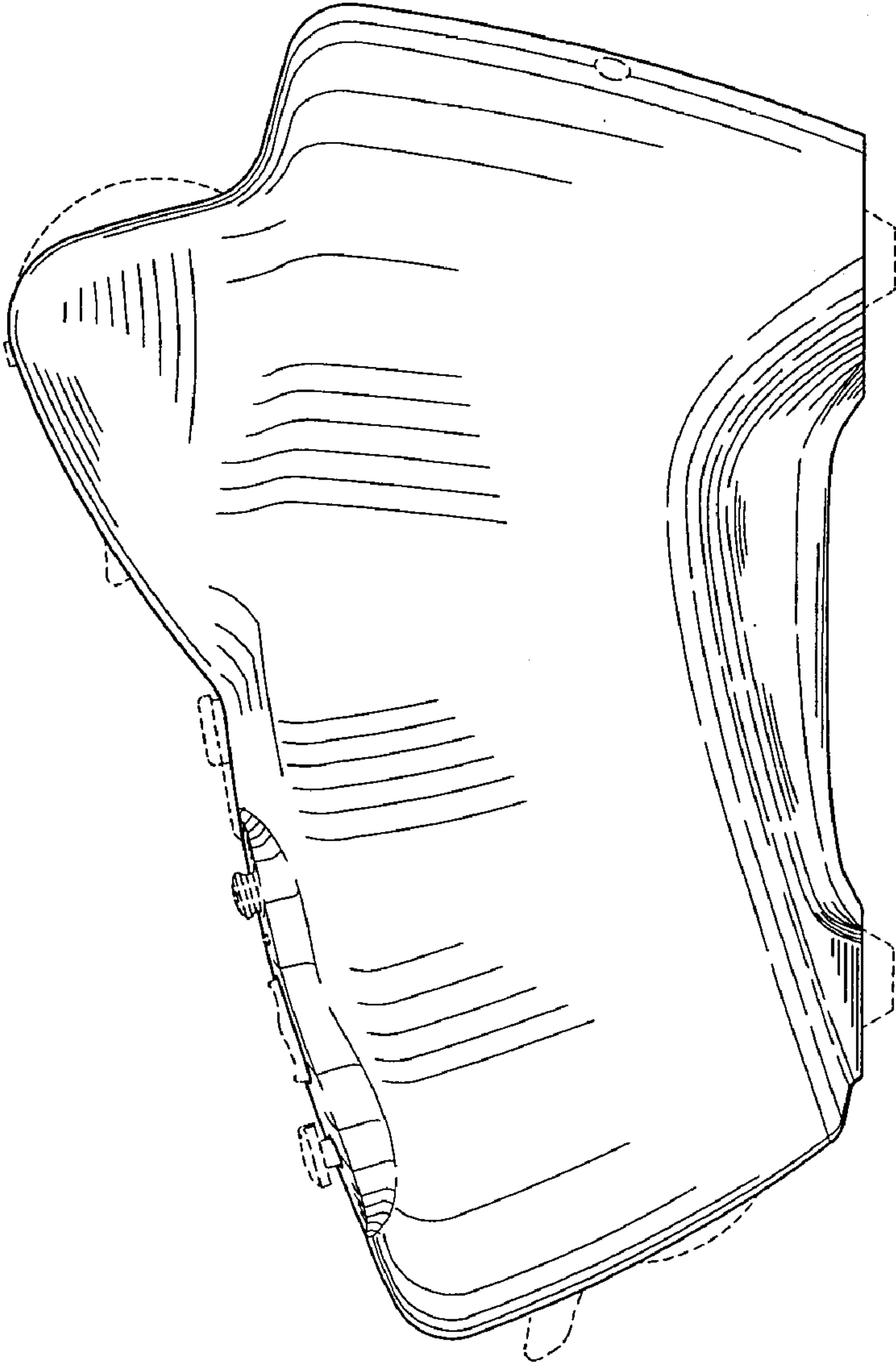

FIG. 6

FIG. 7



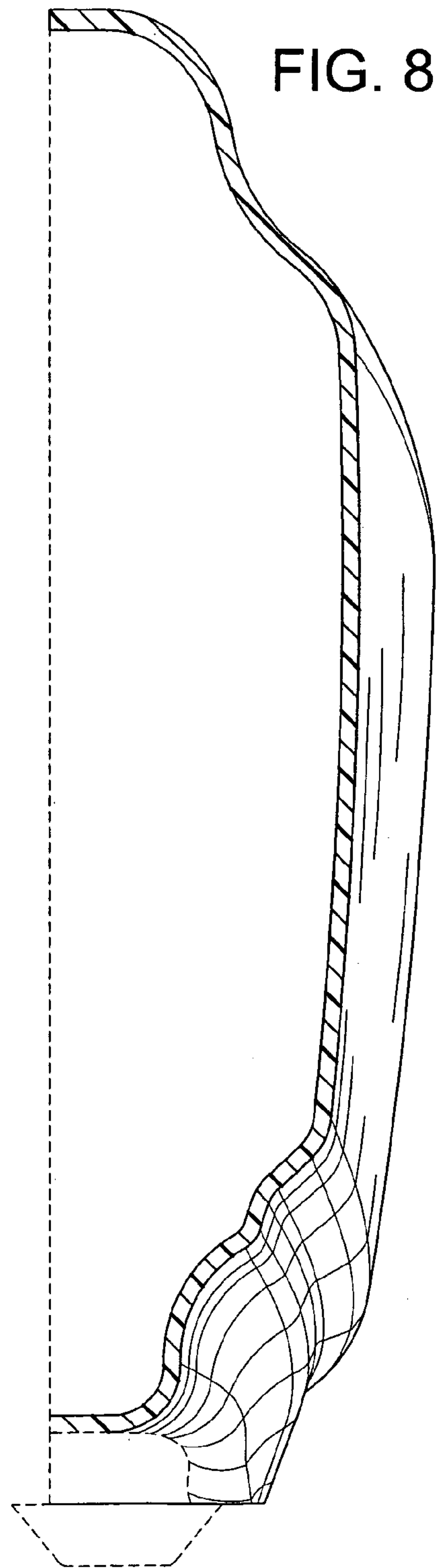
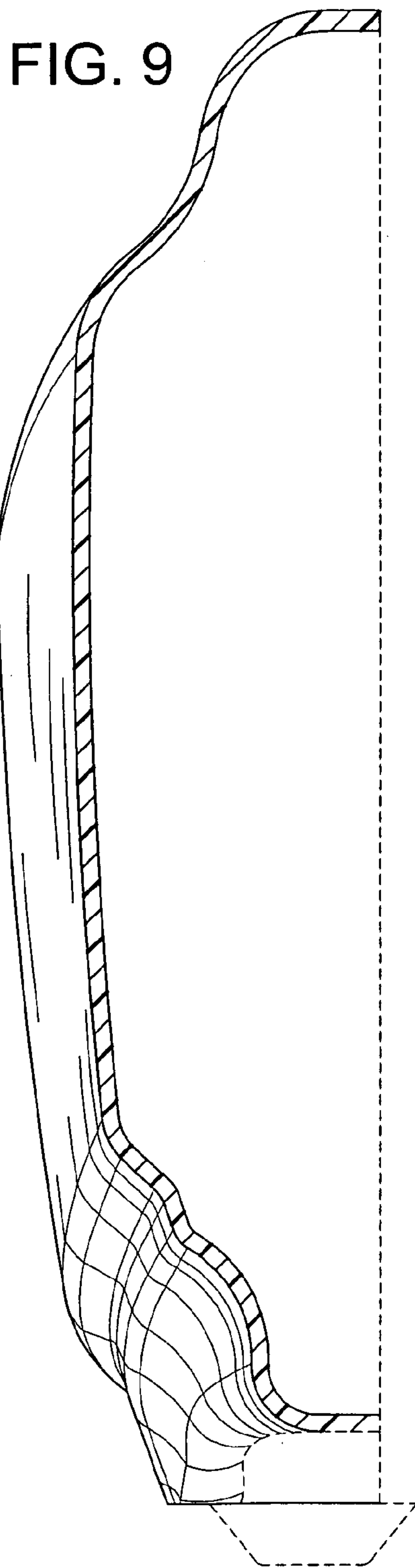

FIG. 10

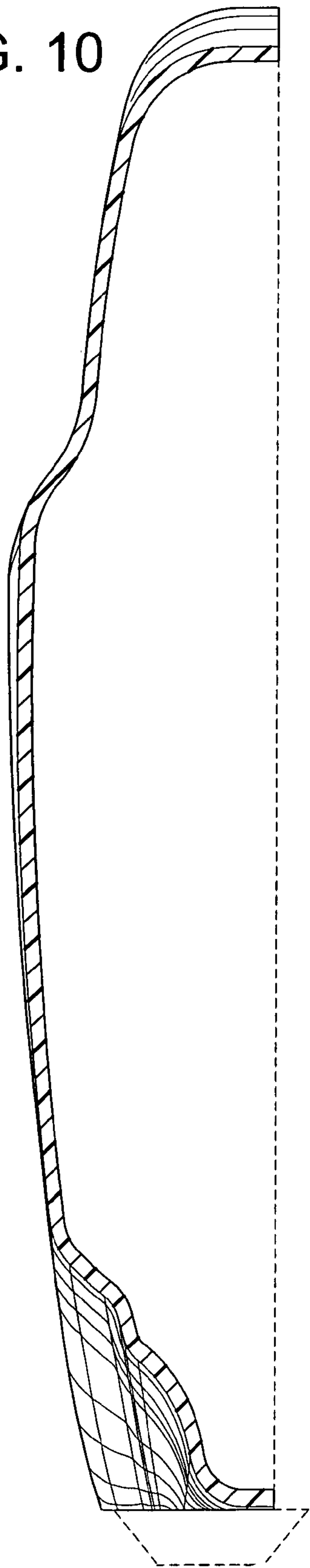

FIG. 11

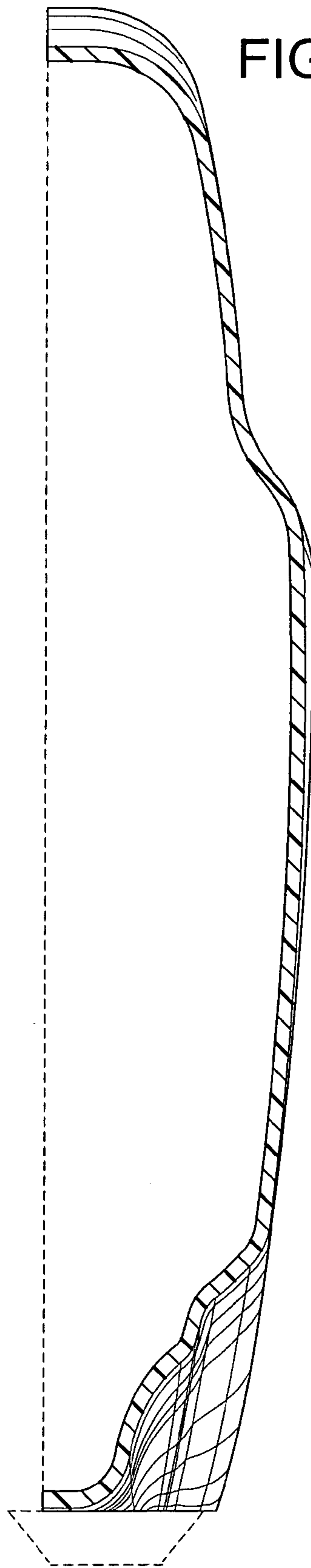

FIG. 12

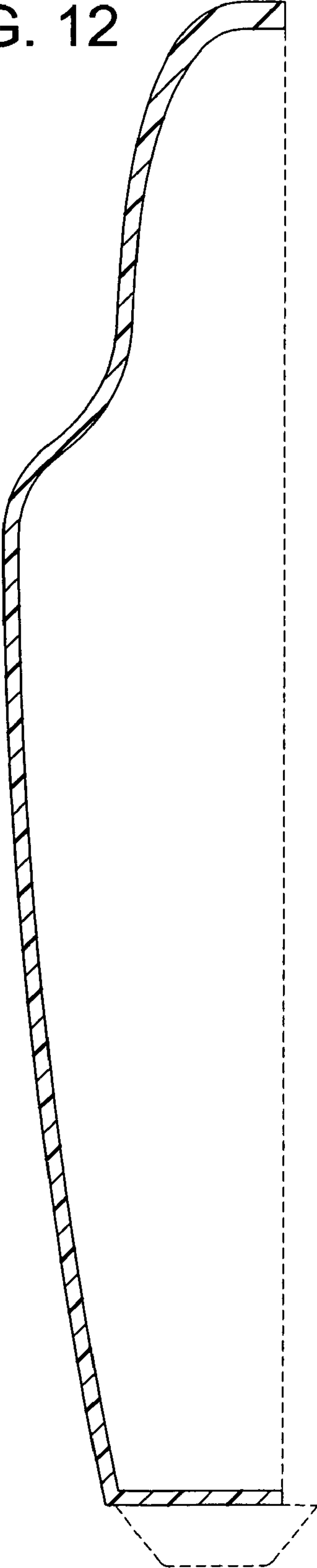
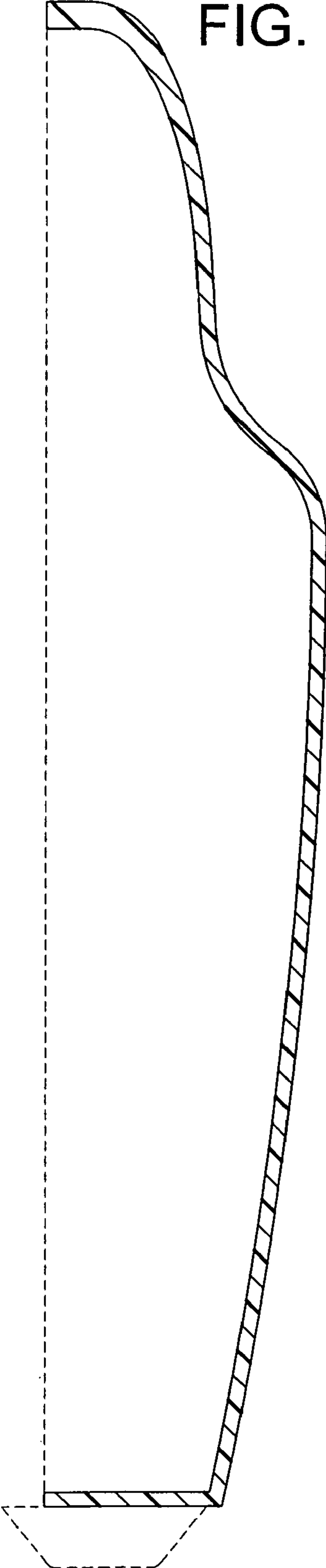

FIG. 13



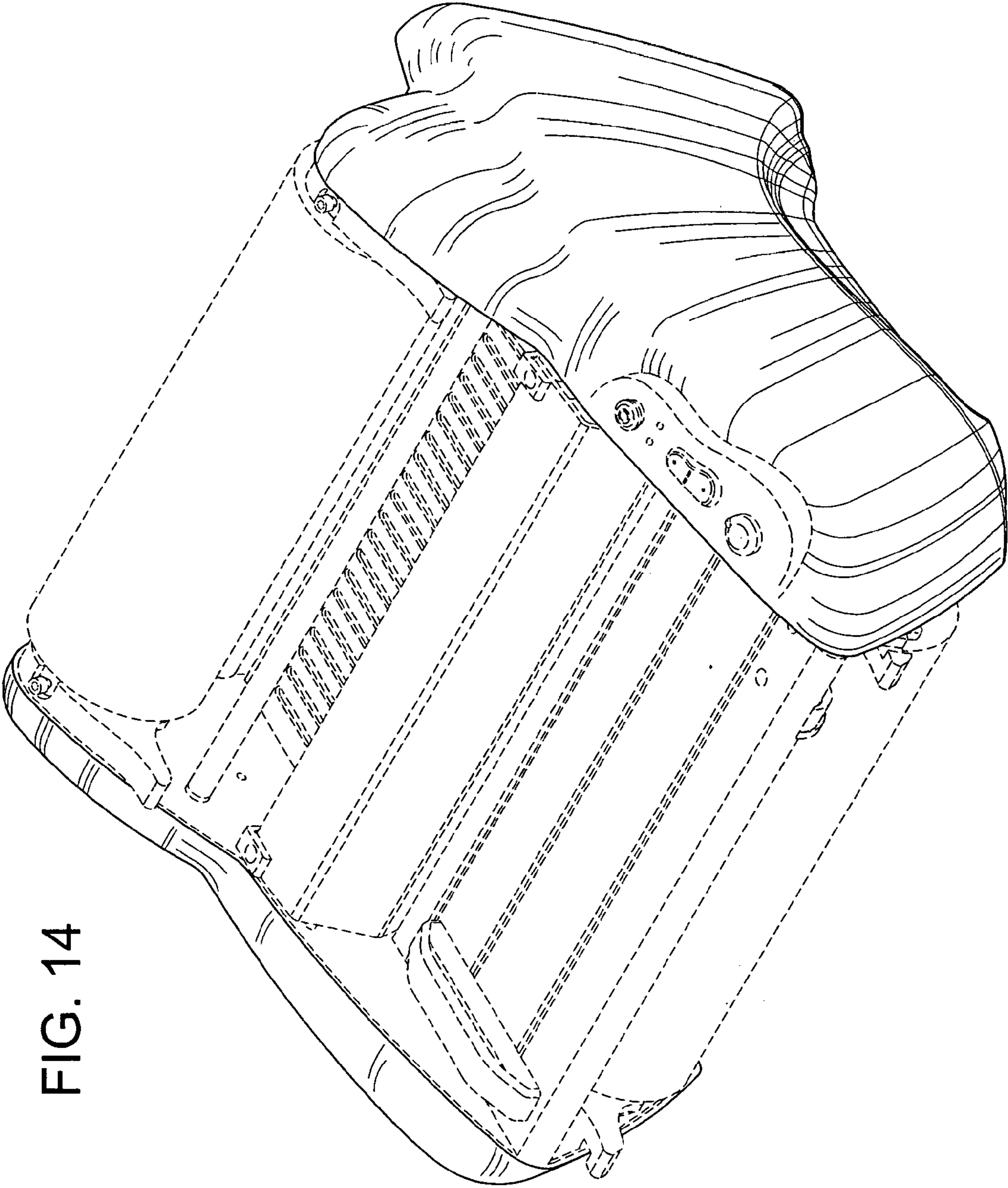

FIG. 14

FIG. 15

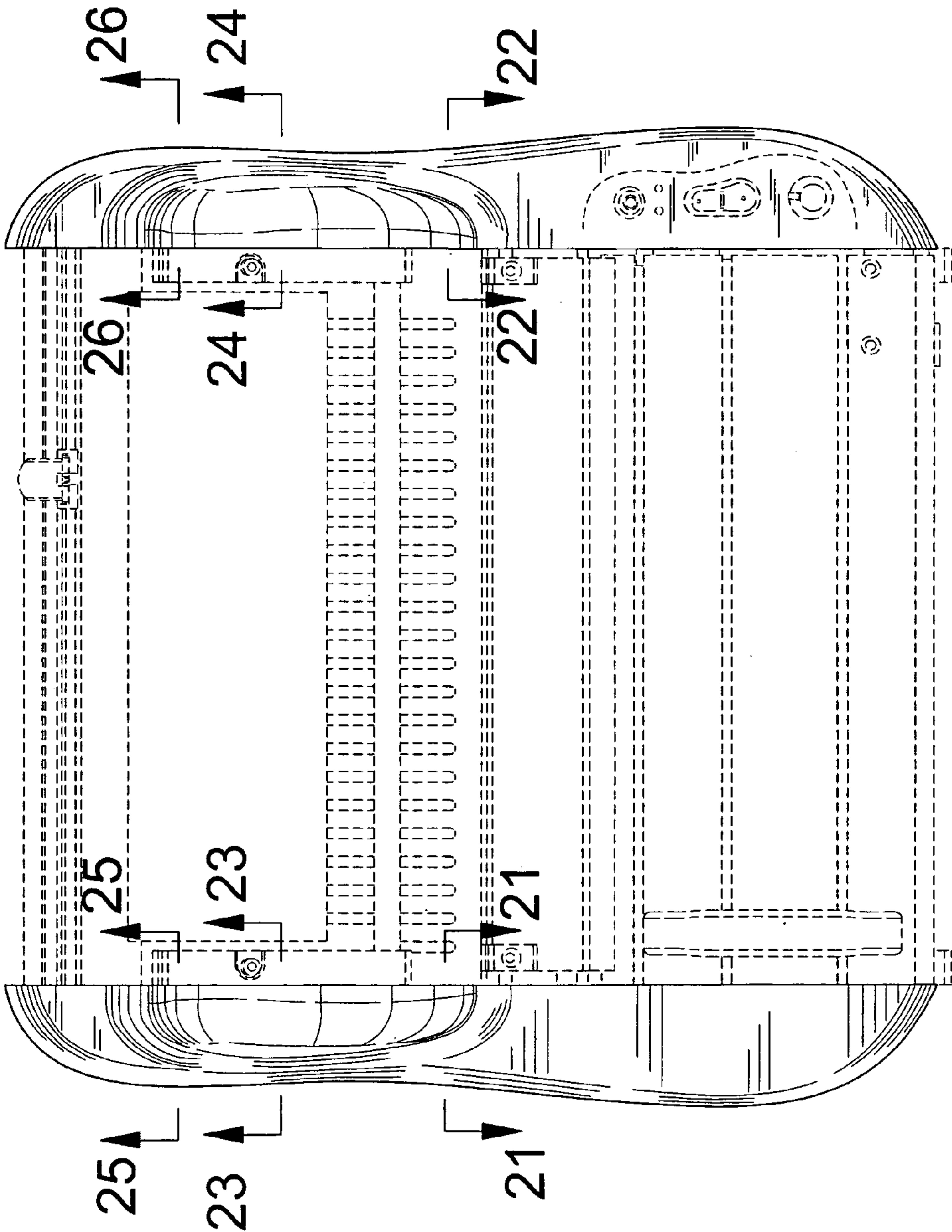

FIG. 16

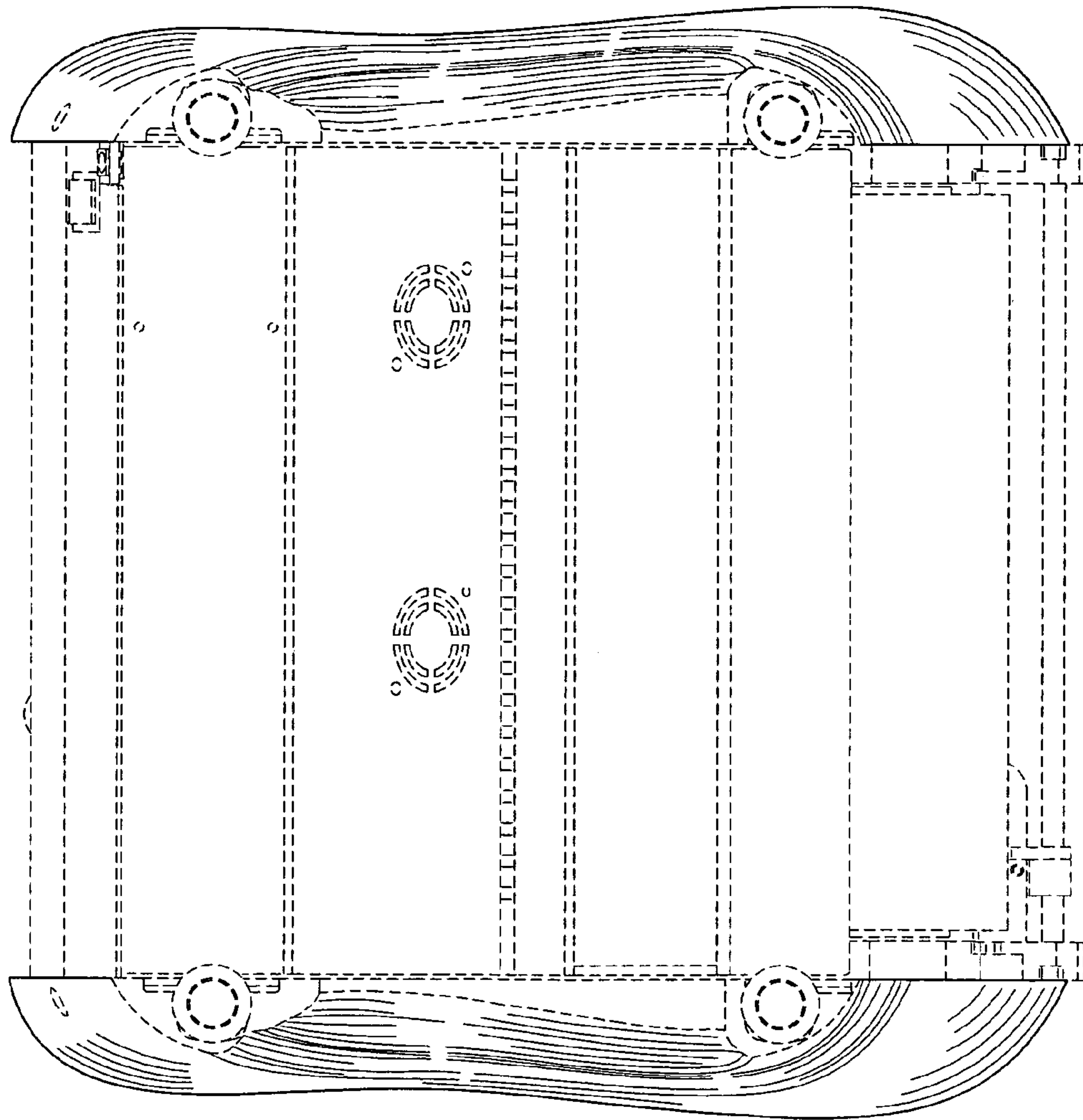

FIG. 17

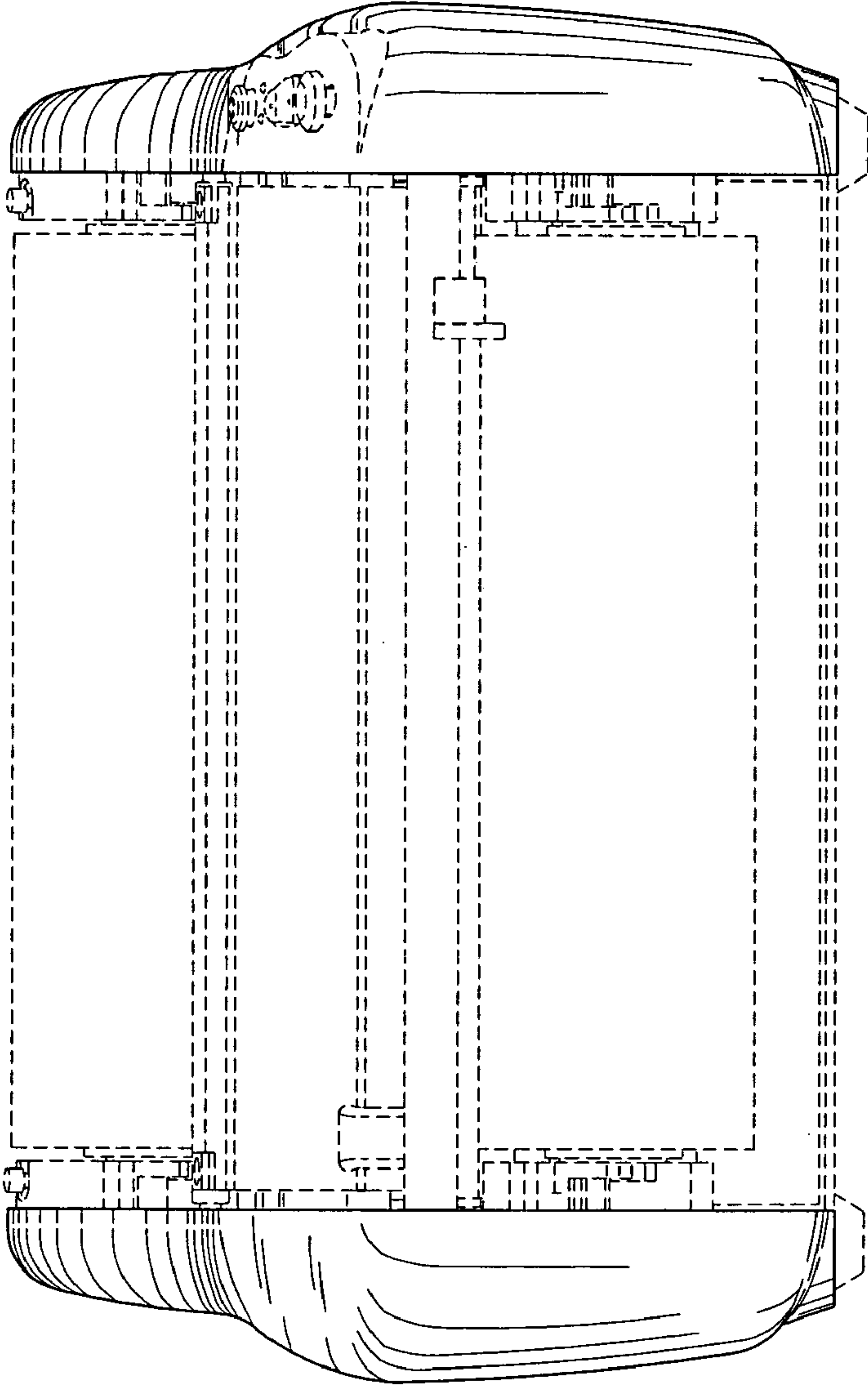
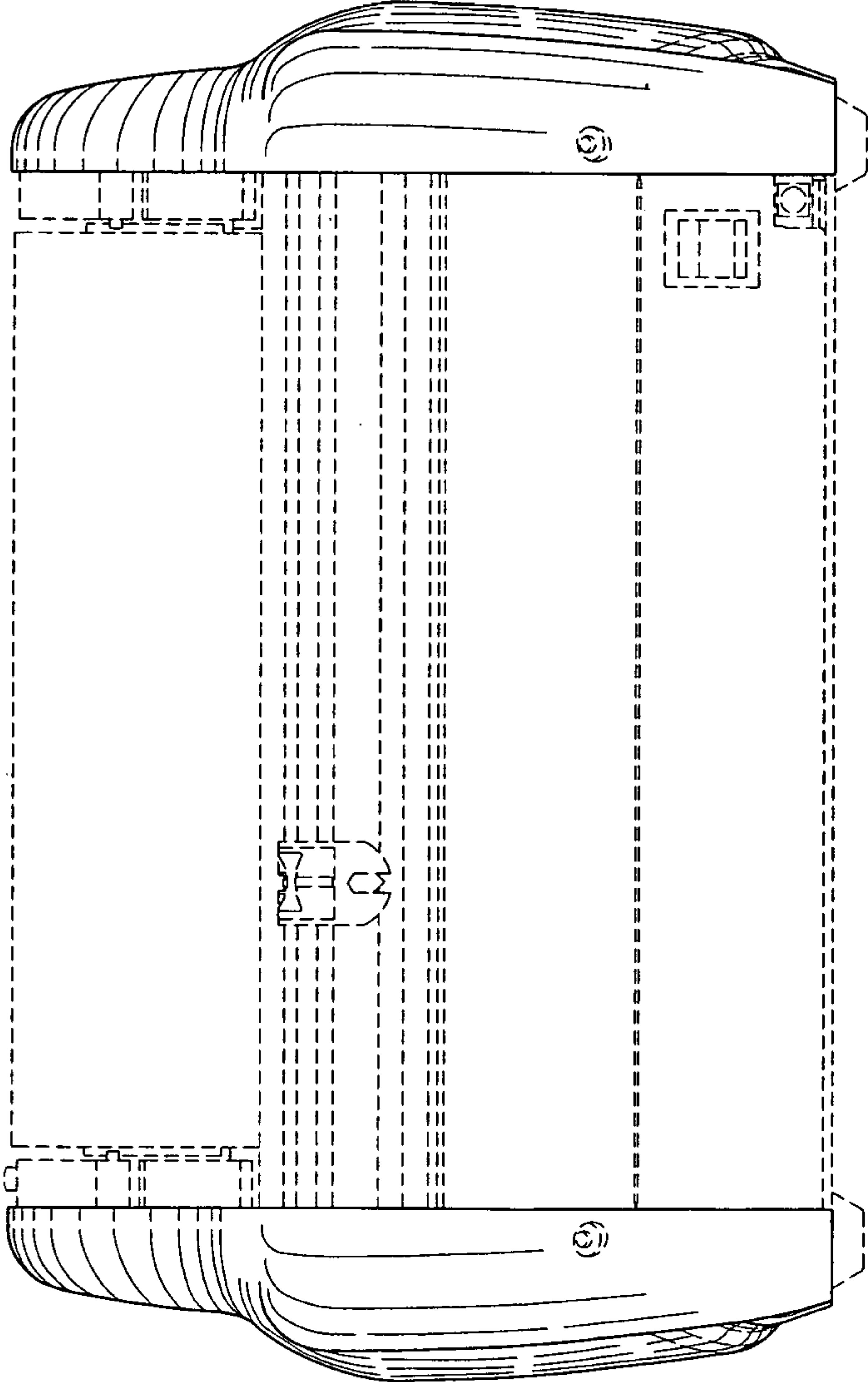

FIG. 18



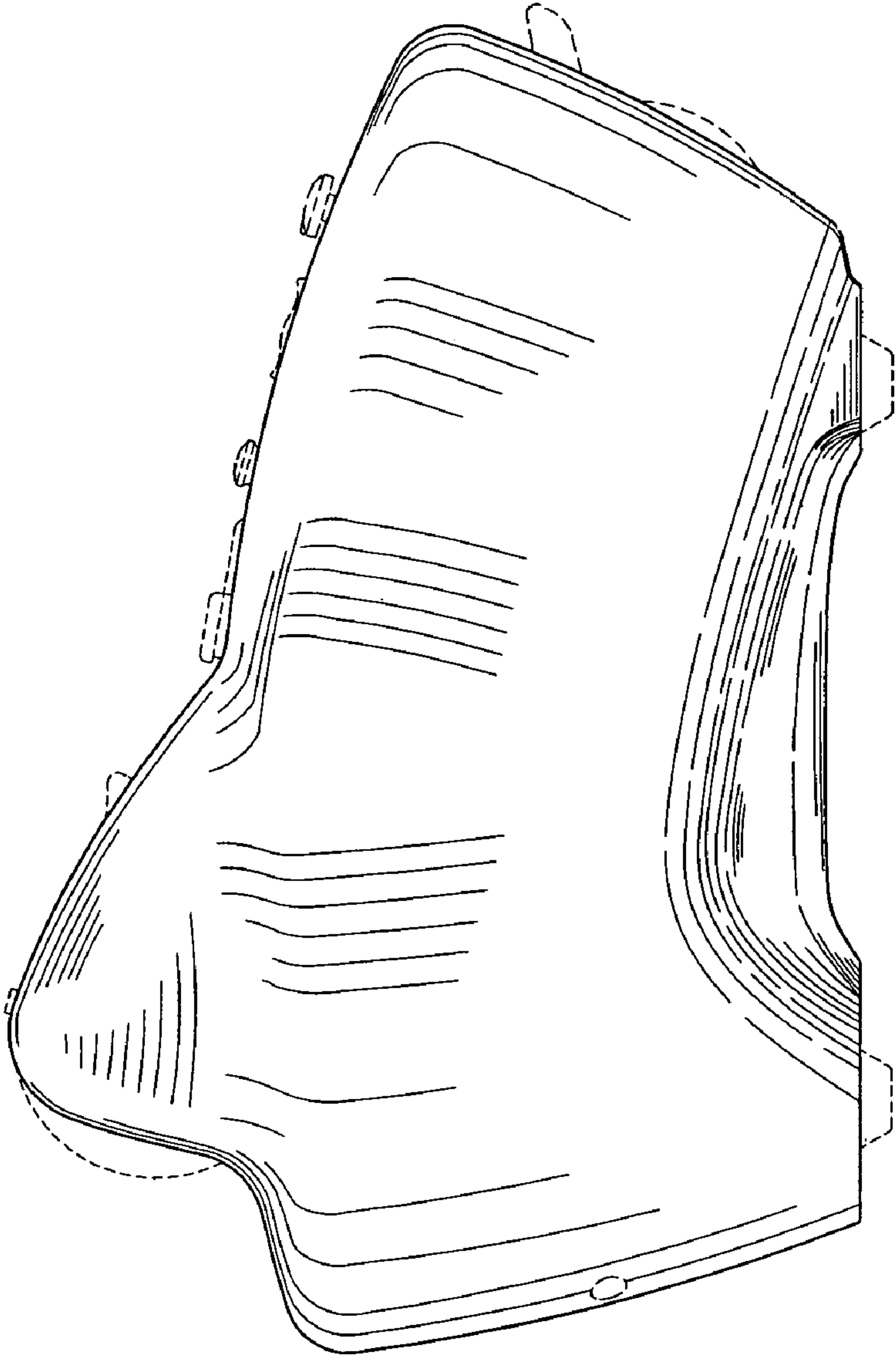

FIG. 19

FIG. 20

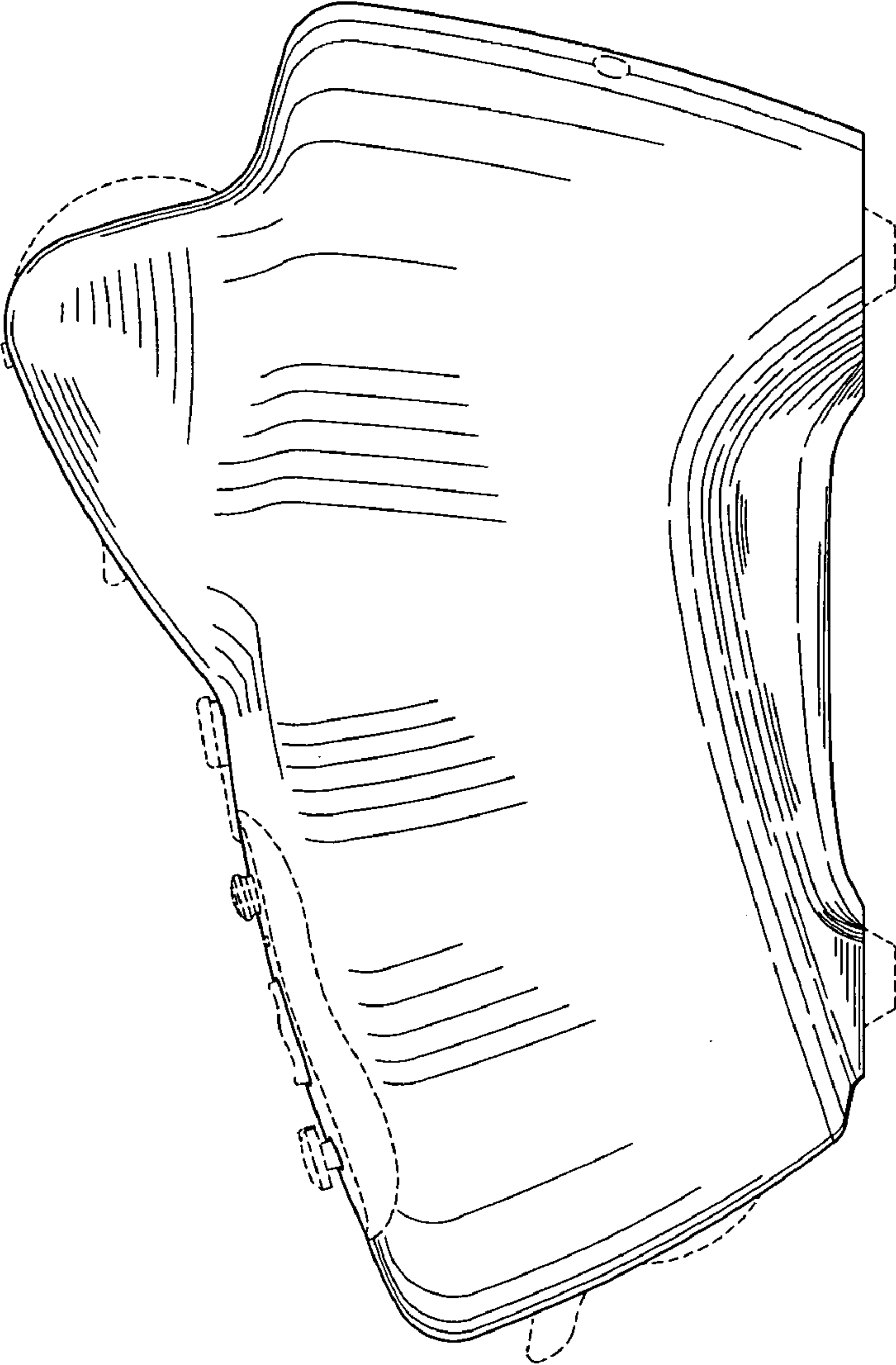

FIG. 22

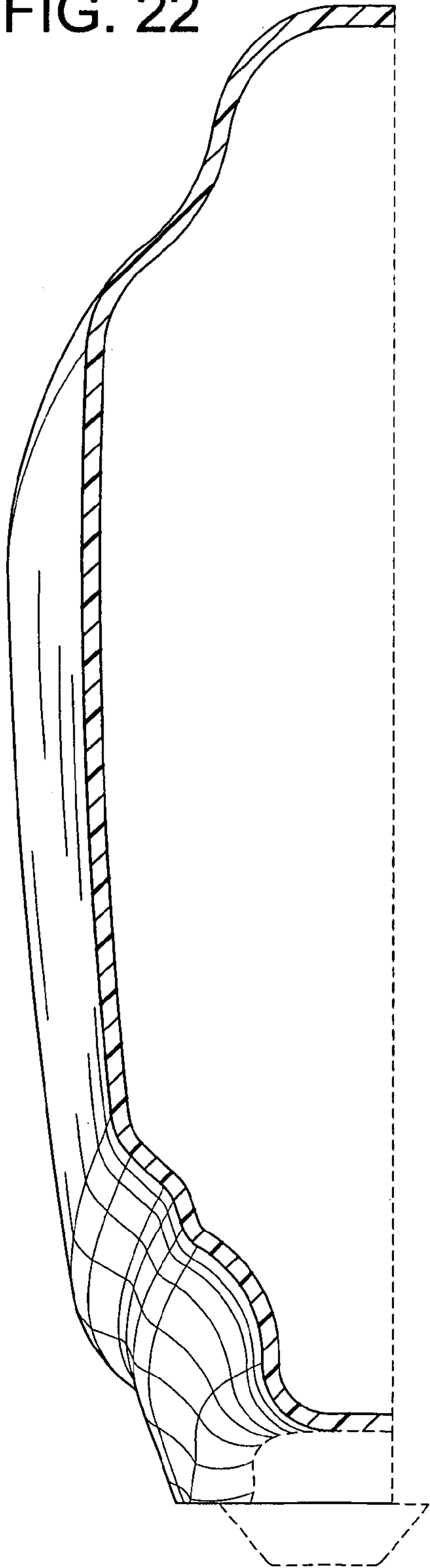

FIG. 21

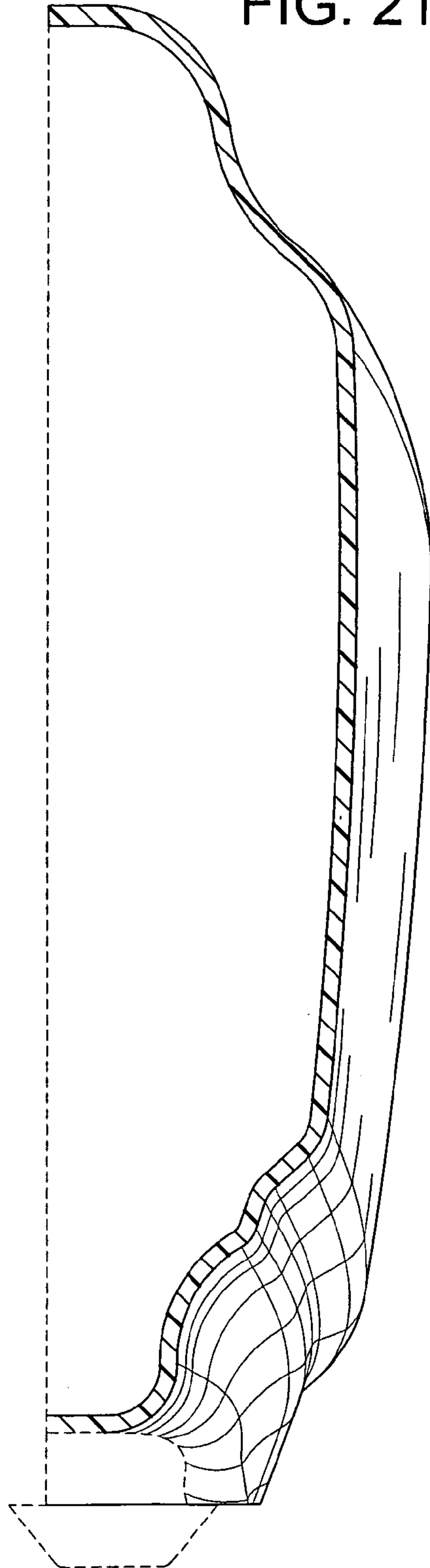

FIG. 23

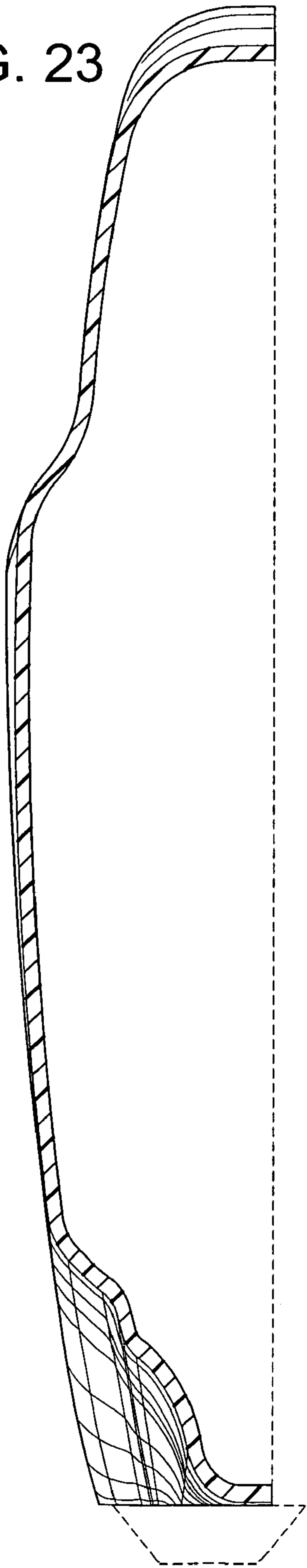

FIG. 24

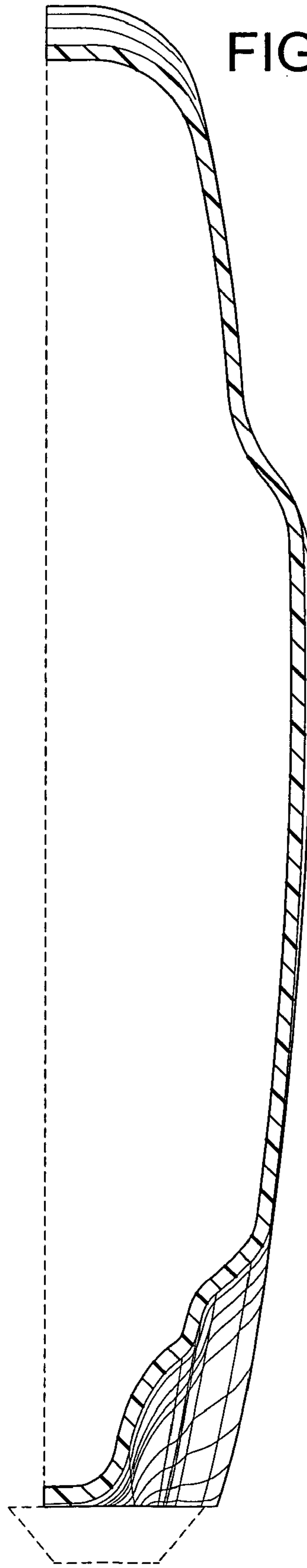

FIG. 25

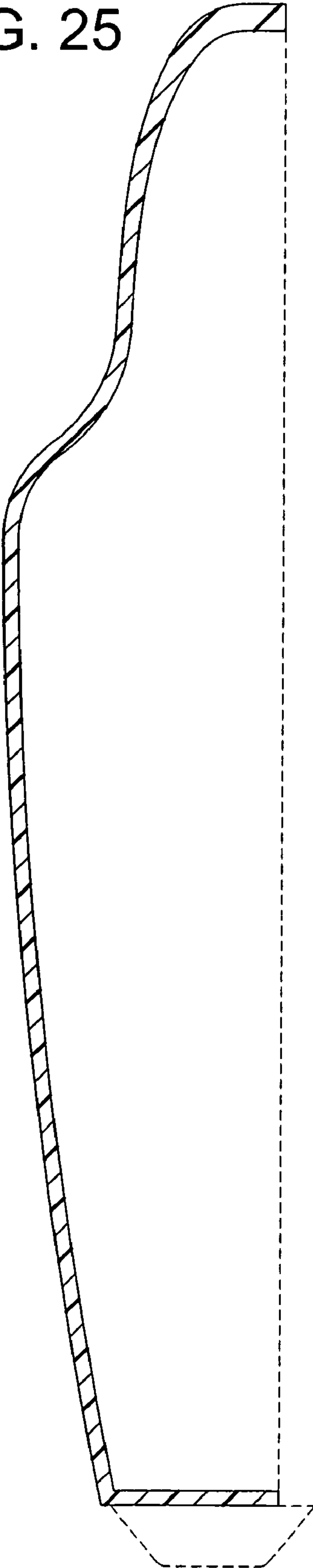

FIG. 26

