



US00D546852S

(12) **United States Design Patent**
Shimojima

(10) **Patent No.:** **US D546,852 S**

(45) **Date of Patent:** **** Jul. 17, 2007**

(54) **STRAPPING PACKING MACHINE WITH DOOR**

2003/0006012 A1* 1/2003 Lai 100/8
* cited by examiner

(75) Inventor: **Toshio Shimojima**, Kawasaki (JP)

Primary Examiner—Antoine D. Davis

(73) Assignee: **Strapack Corporation**, Tokyo (JP)

Assistant Examiner—Patricia Palasik

(**) Term: **14 Years**

(74) *Attorney, Agent, or Firm*—Wolf, Block, Schorr & Solis-Cohen LLP; William H. Dippert

(21) Appl. No.: **29/240,563**

(57) **CLAIM**

(22) Filed: **Oct. 14, 2005**

The ornamental design for a strapping packing machine with door, as shown and described.

(30) **Foreign Application Priority Data**

DESCRIPTION

Apr. 15, 2005 (JP) 2005-011236

FIG. 1 illustrates a front view of a strapping packing machine with door of the present invention;

(51) **LOC (8) Cl.** **15-99**

FIG. 2 illustrates a rear view of the strapping packing machine with door of the present invention;

(52) **U.S. Cl.** **D15/145**

(58) **Field of Classification Search** D15/145,
D15/146; 100/1, 3, 4, 8, 25, 26, 29, 32; 533/99,
533/589

FIG. 3 illustrates a right side view of the strapping packing machine with door of the present invention;

See application file for complete search history.

FIG. 4 illustrates a left side view of the strapping packing machine with door of the present invention;

(56) **References Cited**

FIG. 5 illustrates a top plan view of the strapping packing machine with door of the present invention; and,

U.S. PATENT DOCUMENTS

FIG. 6 illustrates a bottom plan view of the strapping packing machine with door of the present invention.

- 4,473,005 A * 9/1984 Pasic 100/3
- D424,078 S * 5/2000 Chin-Chang et al. D15/145
- D488,822 S * 4/2004 Shibazaki et al. D15/145
- 6,994,019 B1 * 2/2006 Liu et al. 100/26

1 Claim, 6 Drawing Sheets

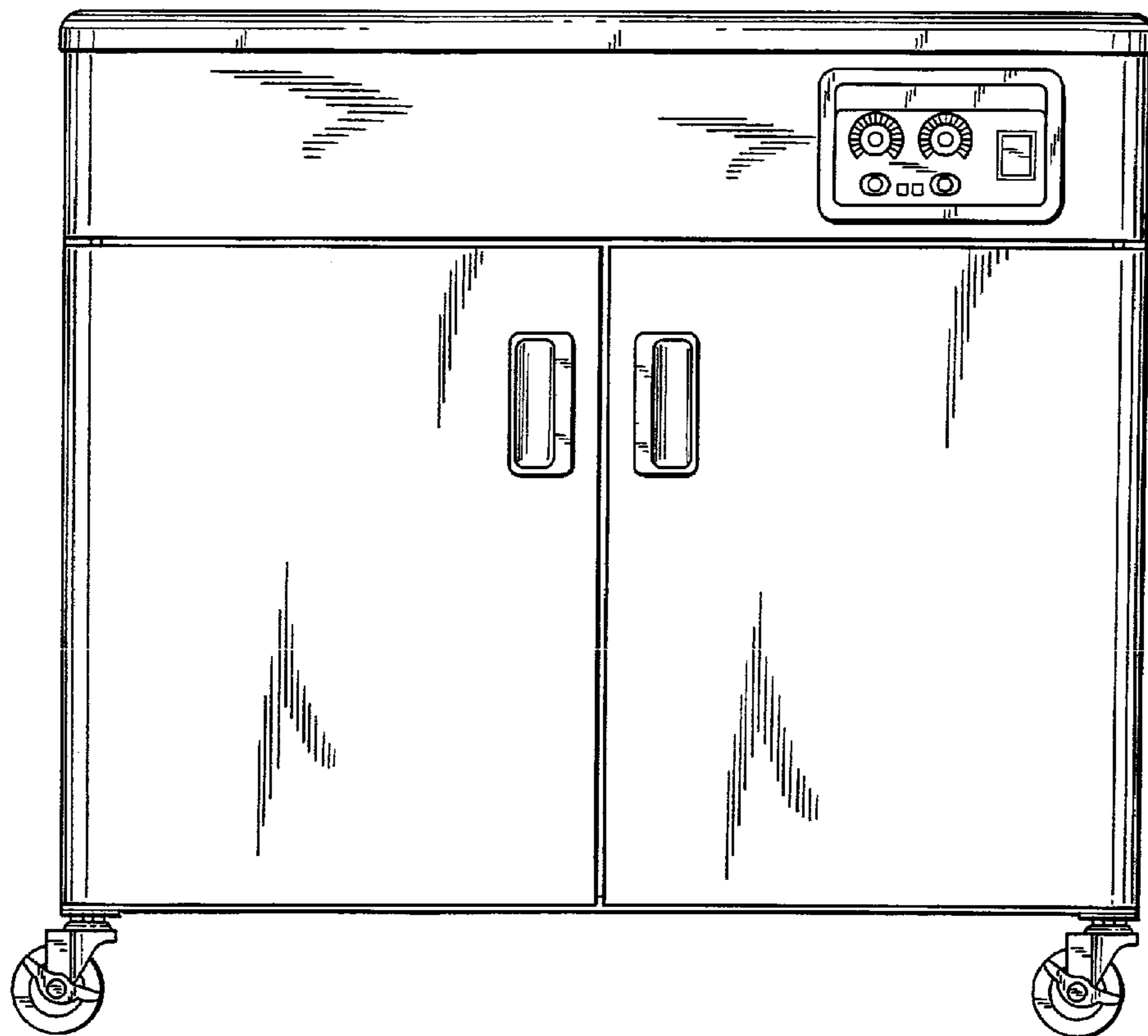

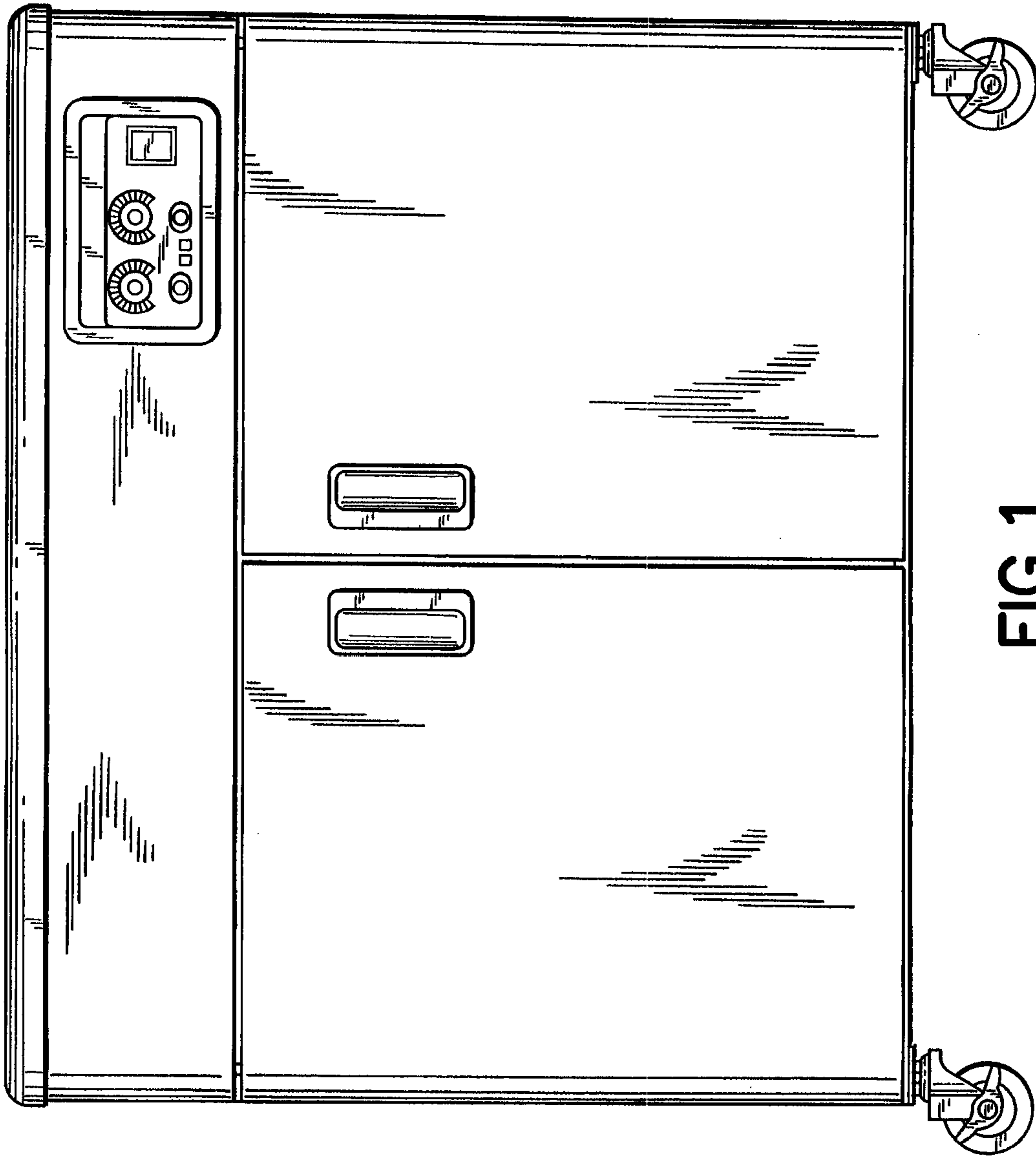

FIG. 1

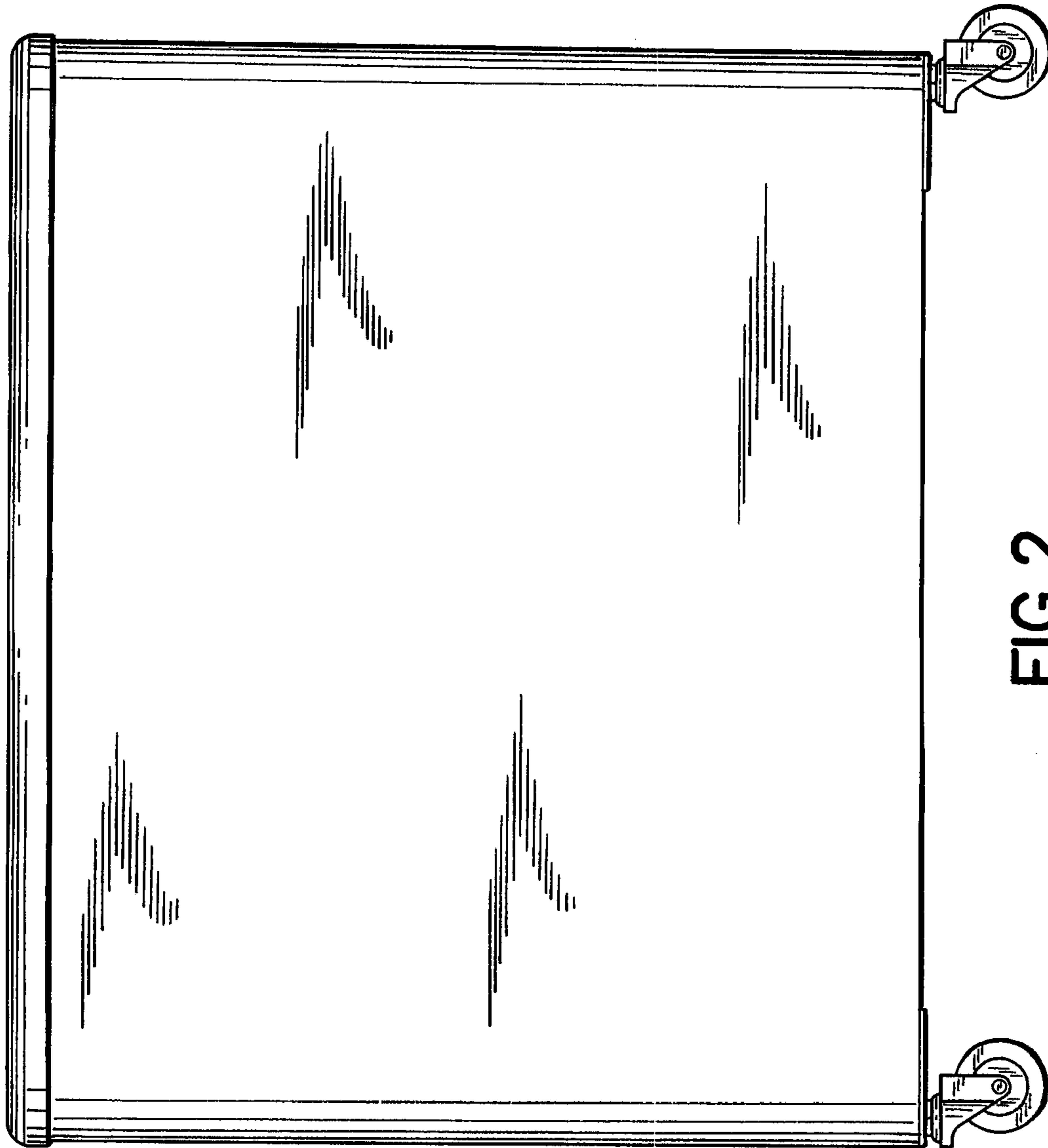

FIG.2

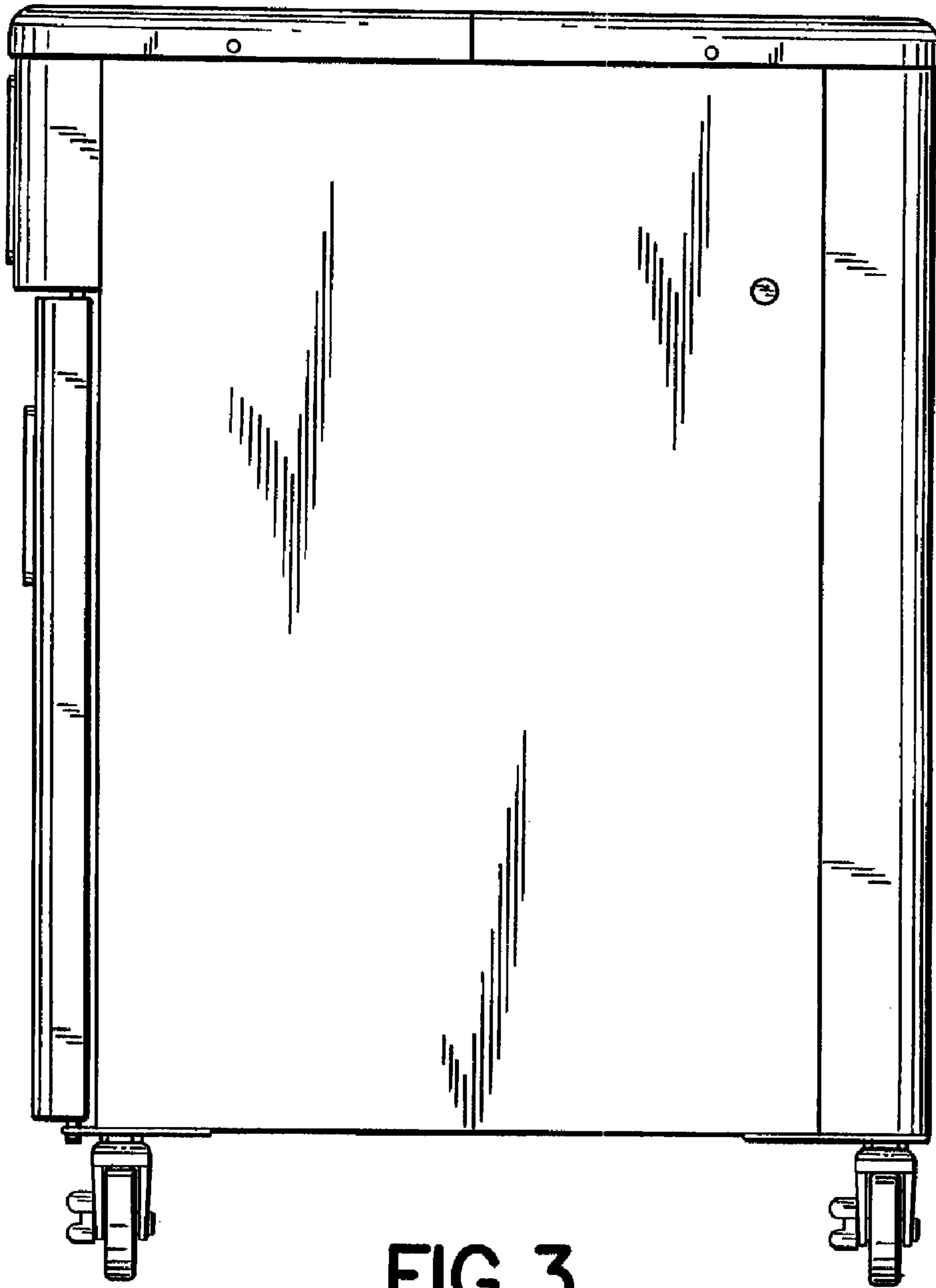

FIG.3

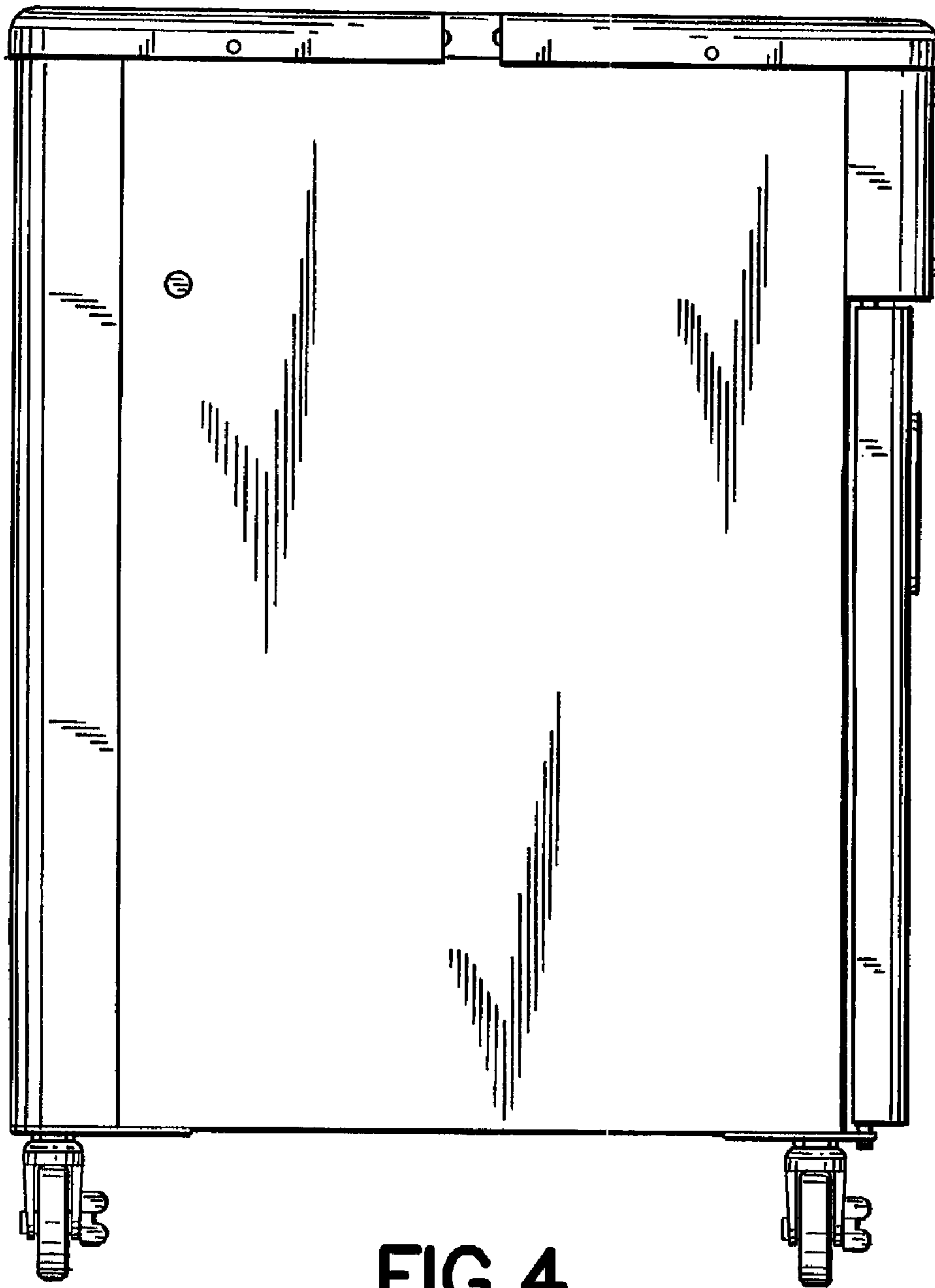

FIG. 4

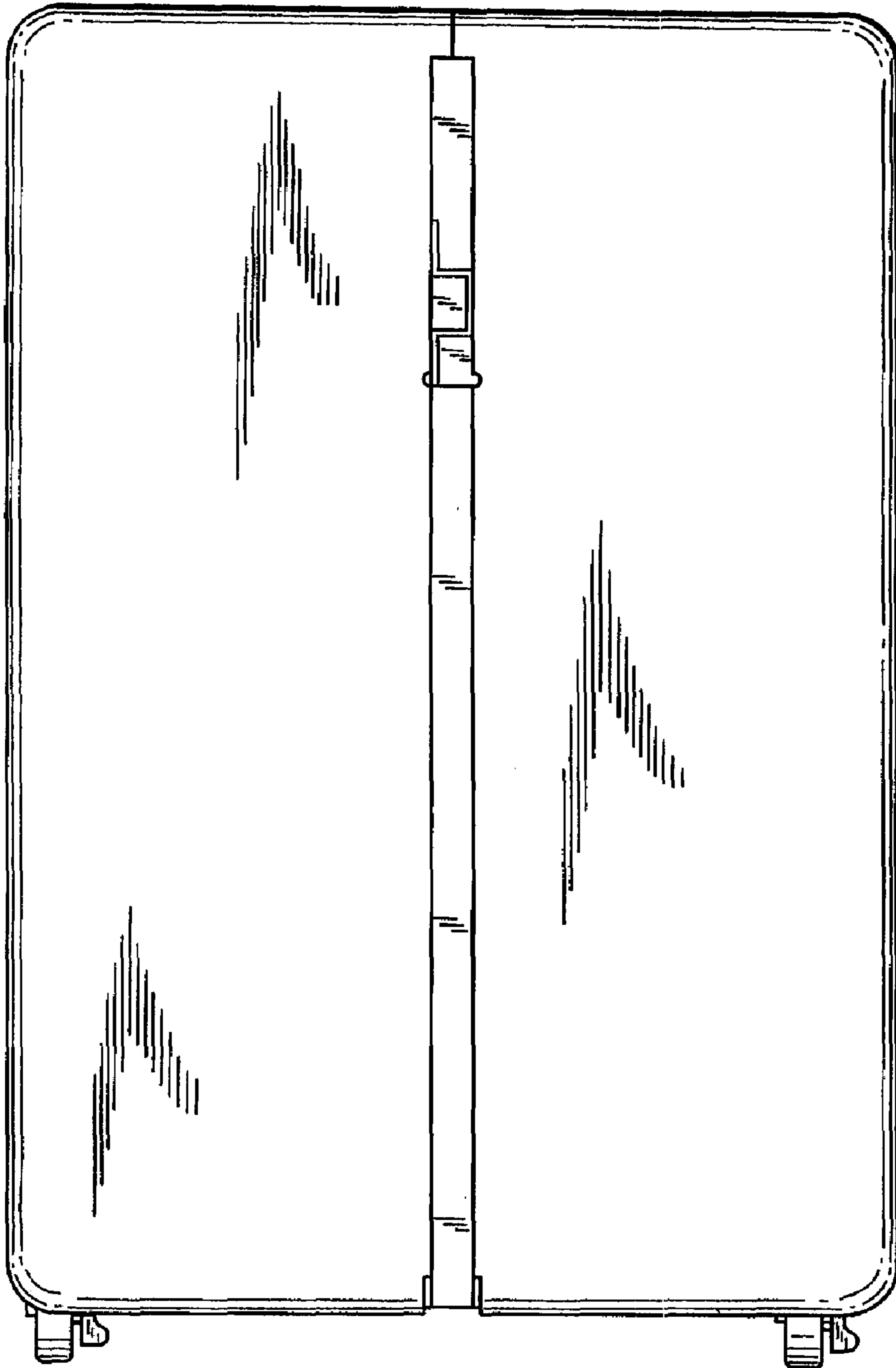

FIG. 5

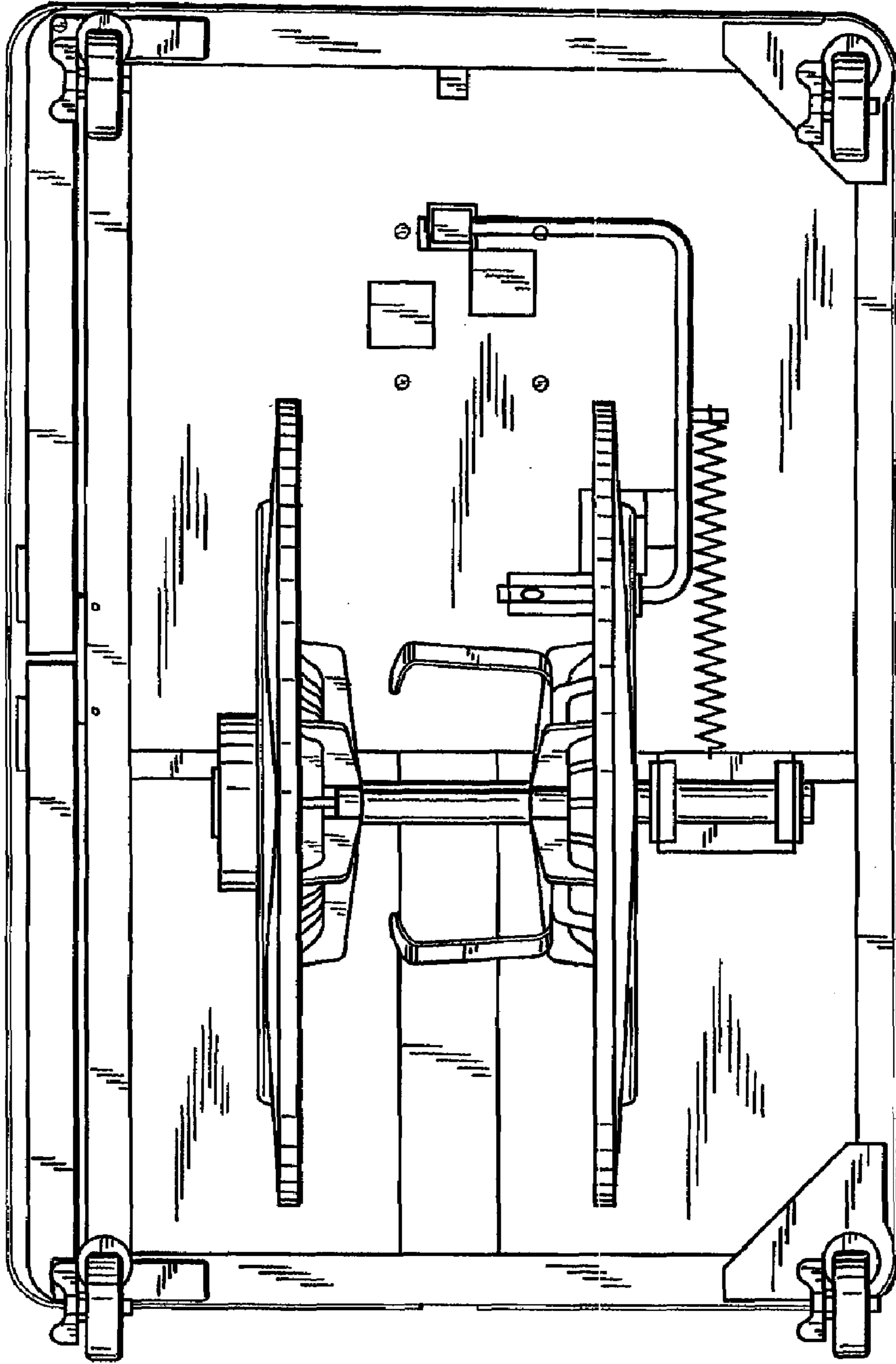

FIG. 6