

US00D546816S

(12) **United States Design Patent** (10) **Patent No.:** **US D546,816 S**
Smith (45) **Date of Patent:** **** Jul. 17, 2007**

(54) **SPEAKER**

(57) **CLAIM**

(76) Inventor: **Glenn Smith**, 6122 Katella Ave.,
Cypress, CA (US) 90630

The ornamental design for a speaker, as shown and described.

(**) Term: **14 Years**

DESCRIPTION

(21) Appl. No.: **29/258,737**

FIG. 1 is a front perspective view of a speaker showing my new design;

(22) Filed: **Apr. 26, 2006**

FIG. 2 is top plan view thereof;

(51) **LOC (8) Cl.** **14-01**

FIG. 3 is a front elevational view thereof;

(52) **U.S. Cl.** **D14/214**

FIG. 4 is a rear elevational view thereof;

(58) **Field of Classification Search** D14/204,
D14/209-216; 181/143-144, 147-148, 150,
181/157, 198-199, 151, 153; 381/300-302,
381/306, 333, 345, 361-364, 386-388, 332,
381/336

FIG. 5 is a right side elevational view thereof, the left side elevational view being a mirror image;

See application file for complete search history.

FIG. 6 is a bottom plan view thereof;

FIG. 7 is a rear perspective view thereof;

FIG. 8 is a front perspective view of a second embodiment of FIG. 1;

FIG. 9 is top plan view of FIG. 8;

FIG. 10 is a front elevational view of FIG. 8;

FIG. 11 is a rear elevational view of FIG. 8;

FIG. 12 is a right side elevational view of FIG. 8, the left side elevational view being a mirror image;

FIG. 13 is a rear perspective view of FIG. 8; and,

FIG. 14 is a bottom plan view of FIG. 8.

FIGS. 1, 7-8 and 13 are on a reduced scale.

The broken lines showing a mark are for illustrative purposes only and form no part of the claimed design.

(56) **References Cited**

U.S. PATENT DOCUMENTS

D415,760 S * 10/1999 Isonaga D14/171
D482,675 S * 11/2003 Carbone D14/214
D491,166 S * 6/2004 Hakoda D14/216
D500,020 S * 12/2004 Tanaka D14/168

* cited by examiner

Primary Examiner—Nanda Bondade

(74) *Attorney, Agent, or Firm*—Clement Cheng

1 Claim, 6 Drawing Sheets

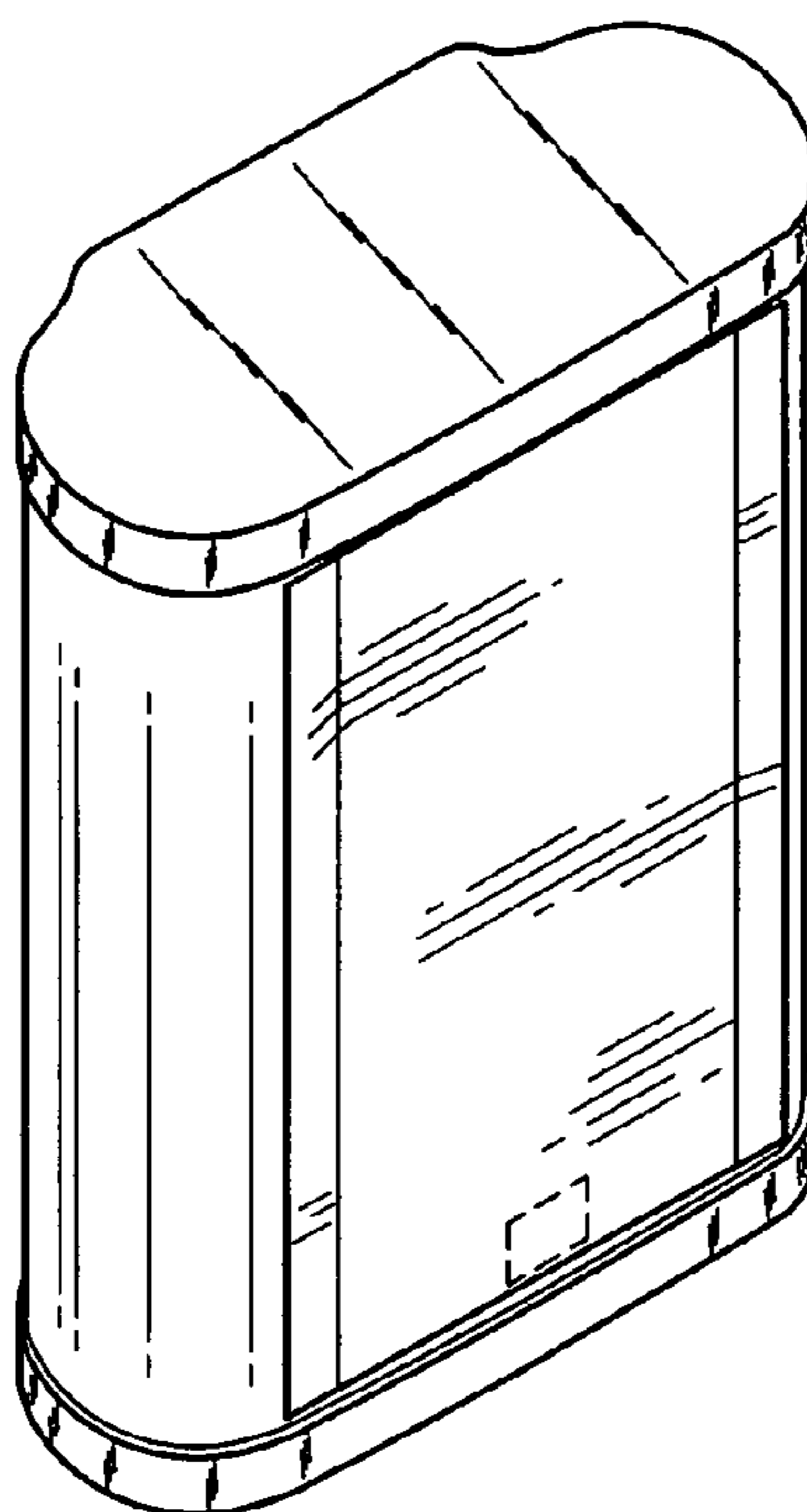

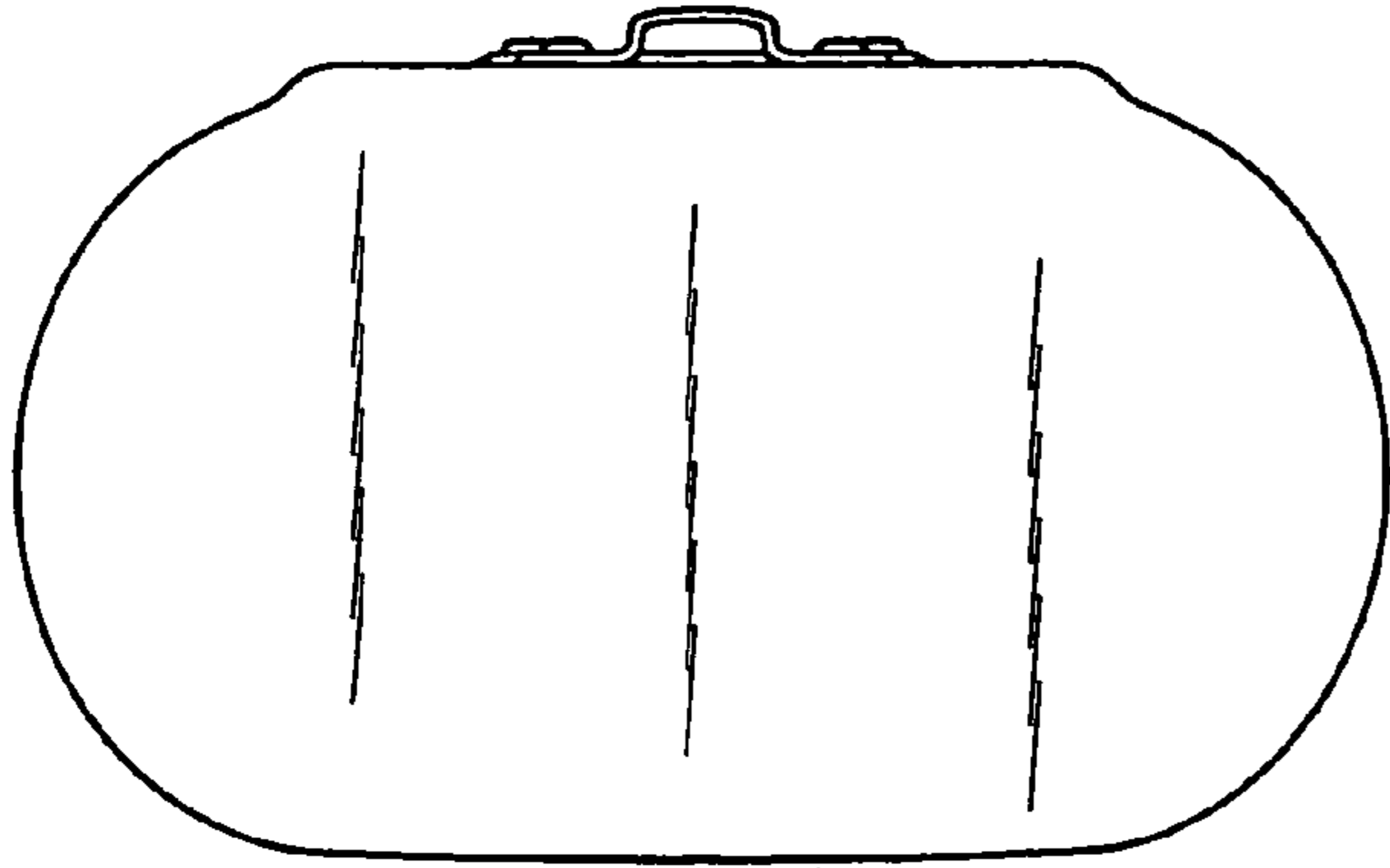

FIG. 2

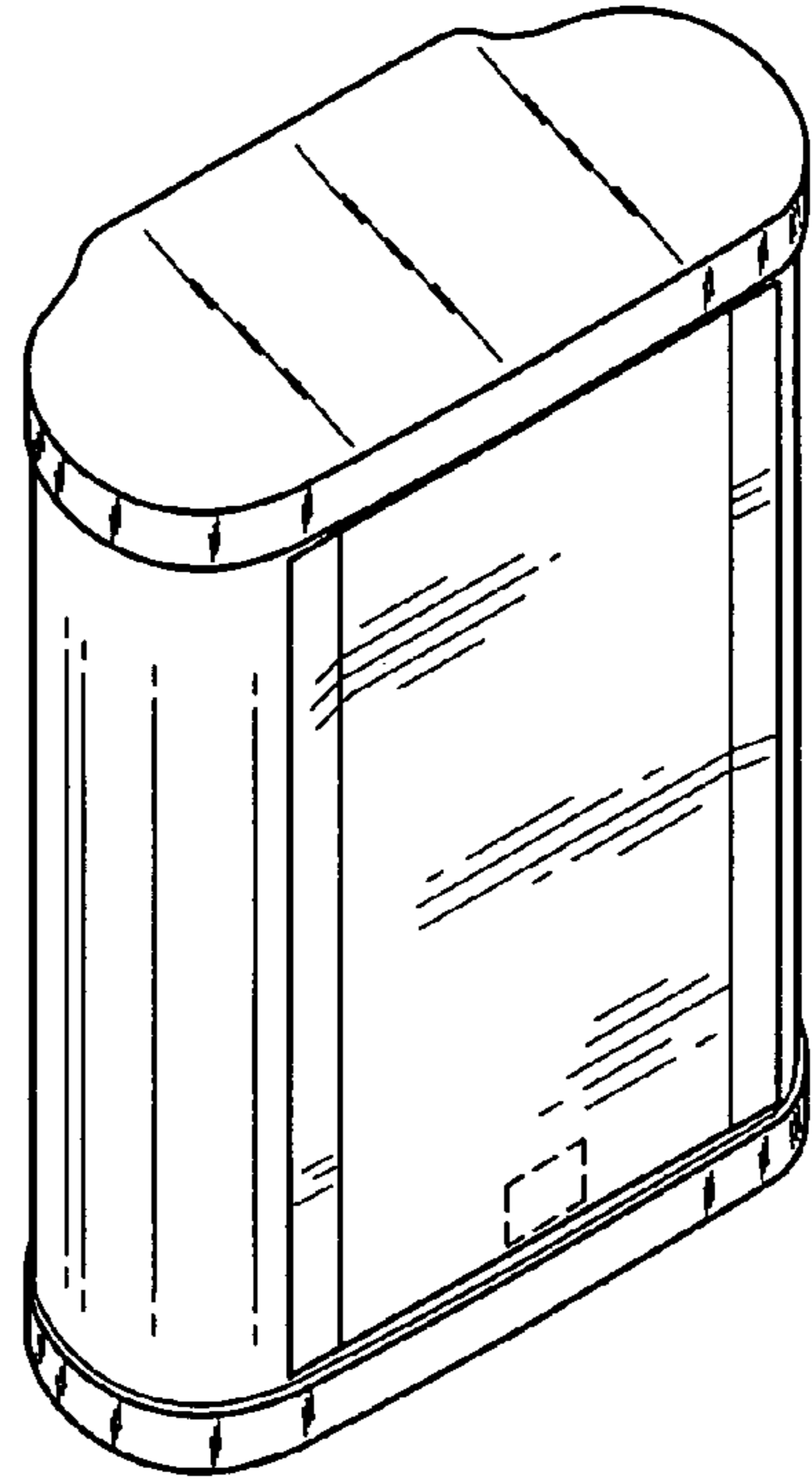

FIG. 1

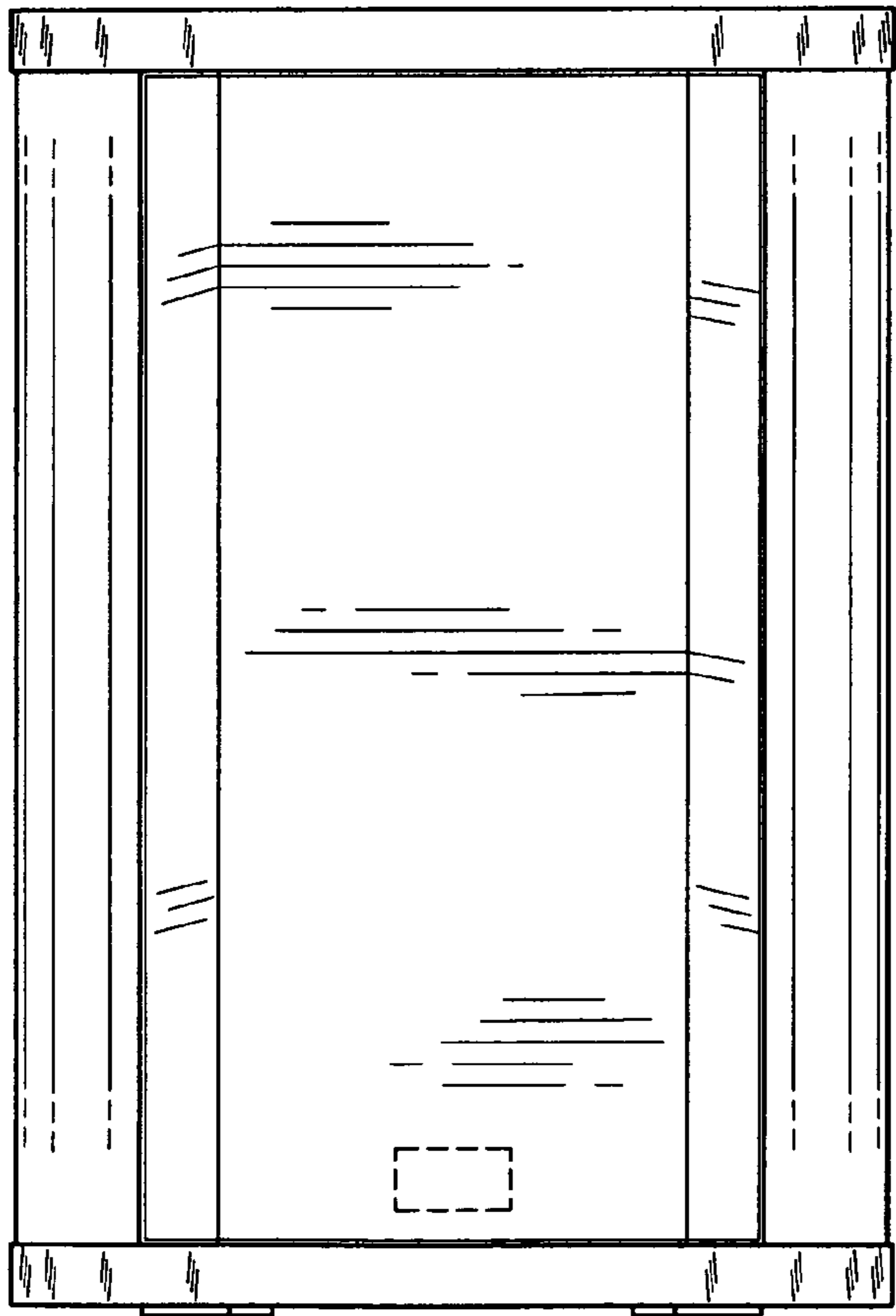

FIG. 3

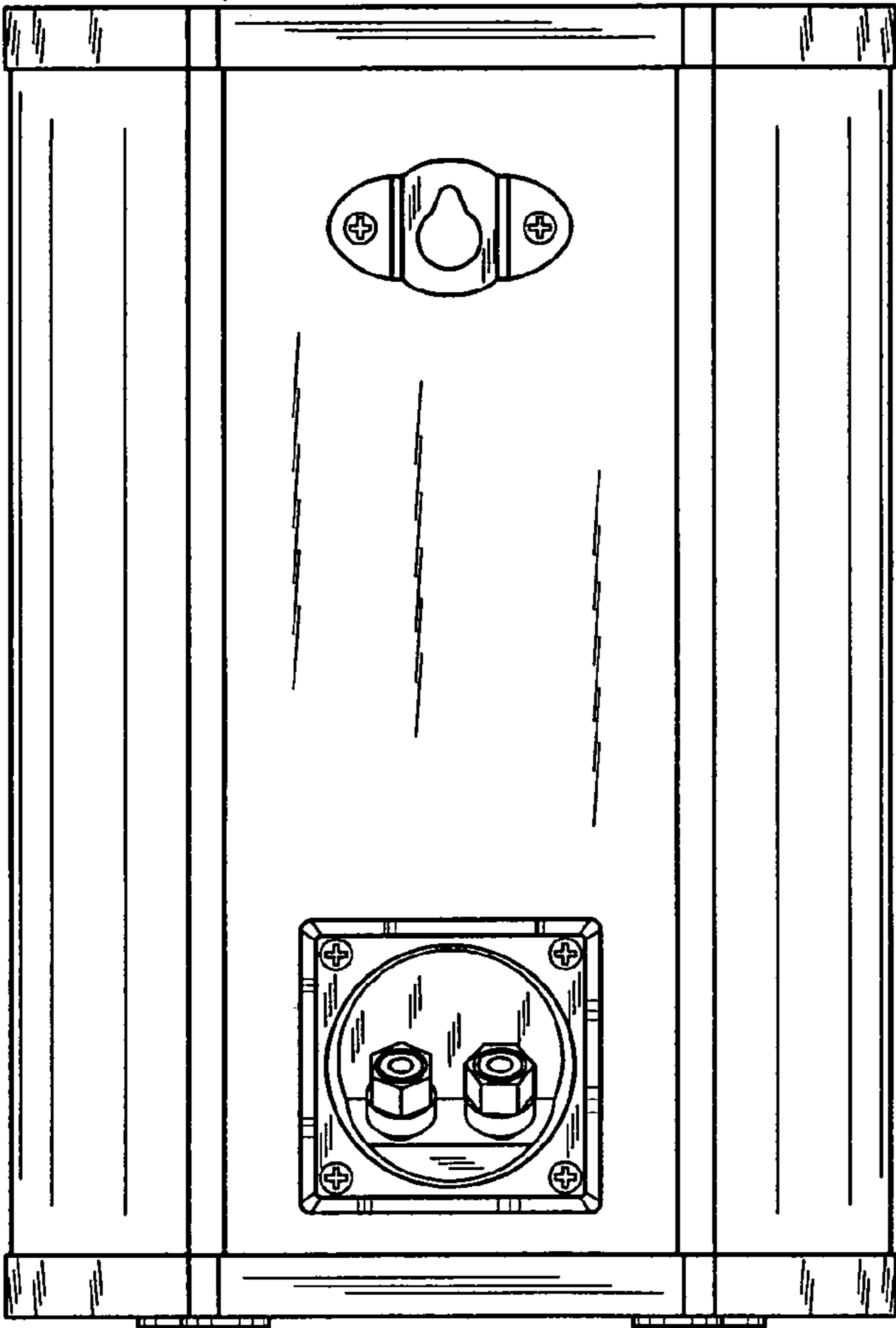

FIG. 4

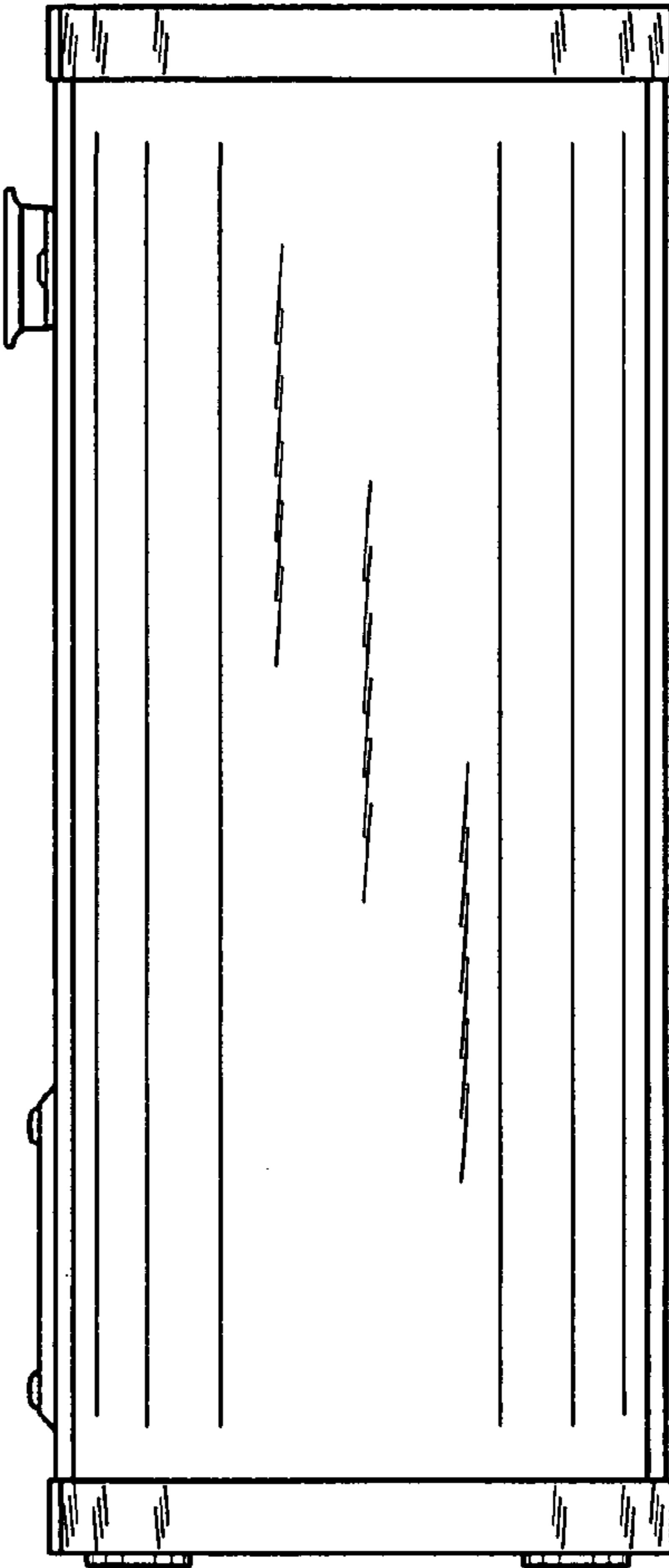

FIG. 5

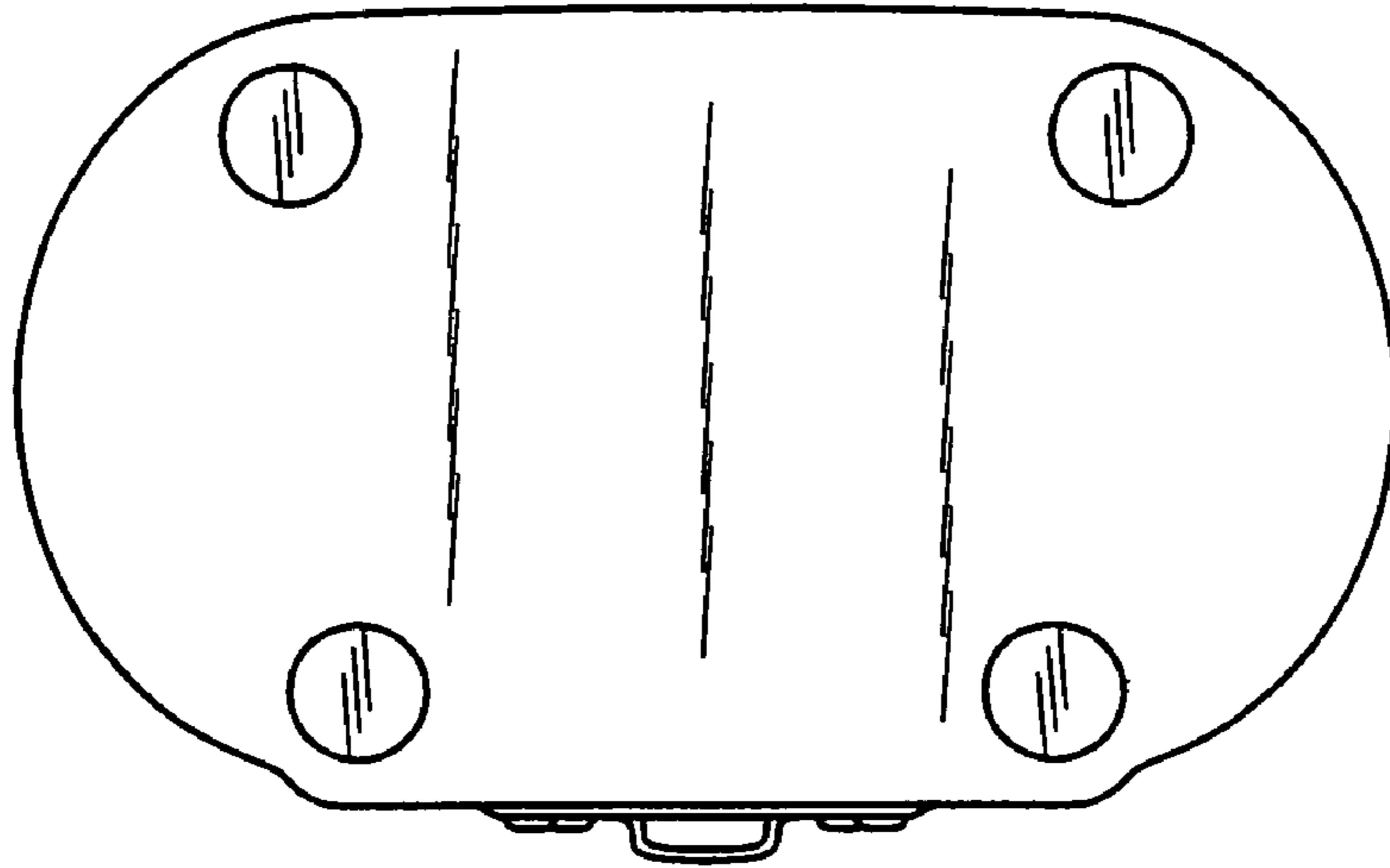

FIG. 6

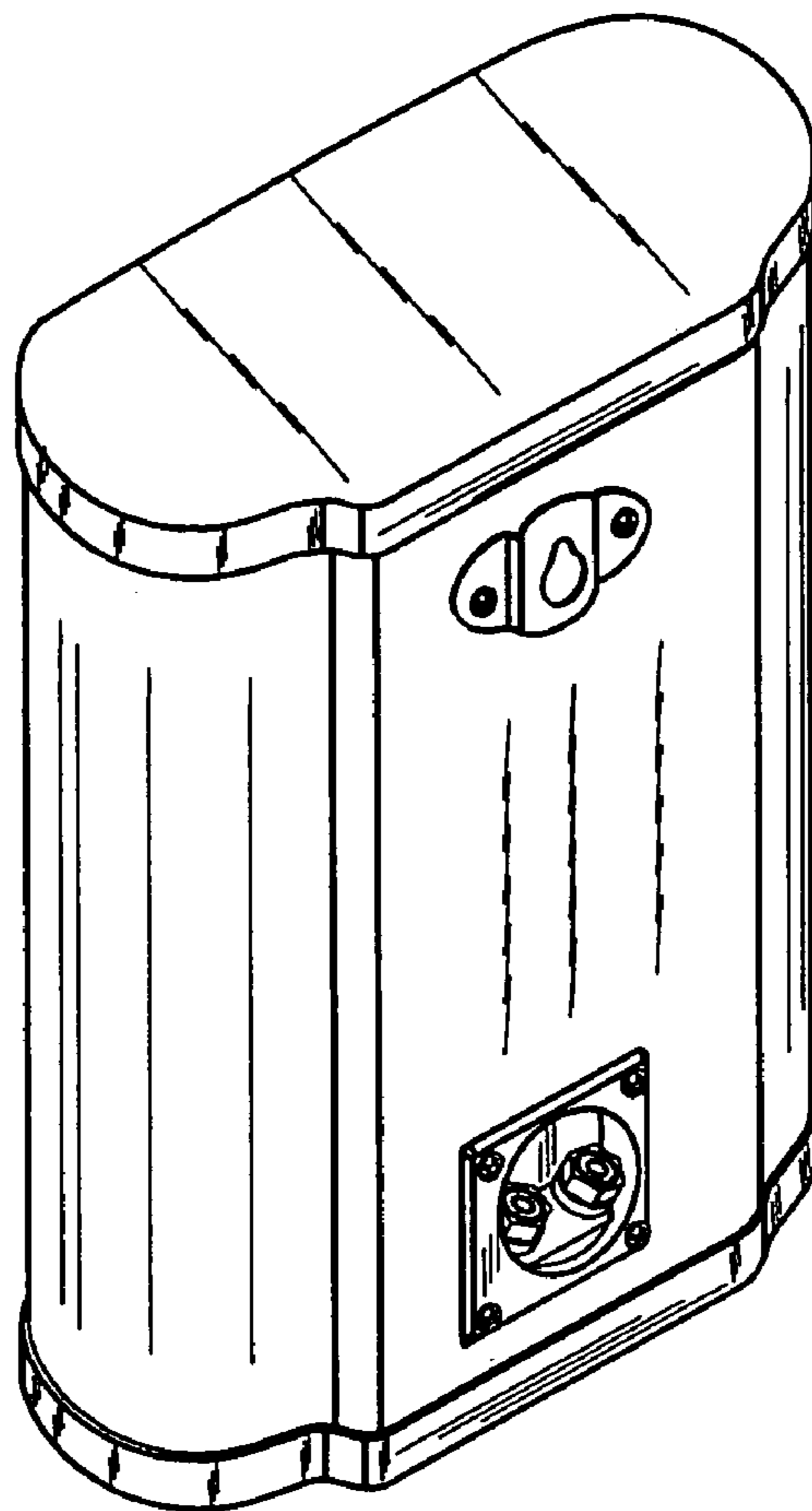

FIG. 7

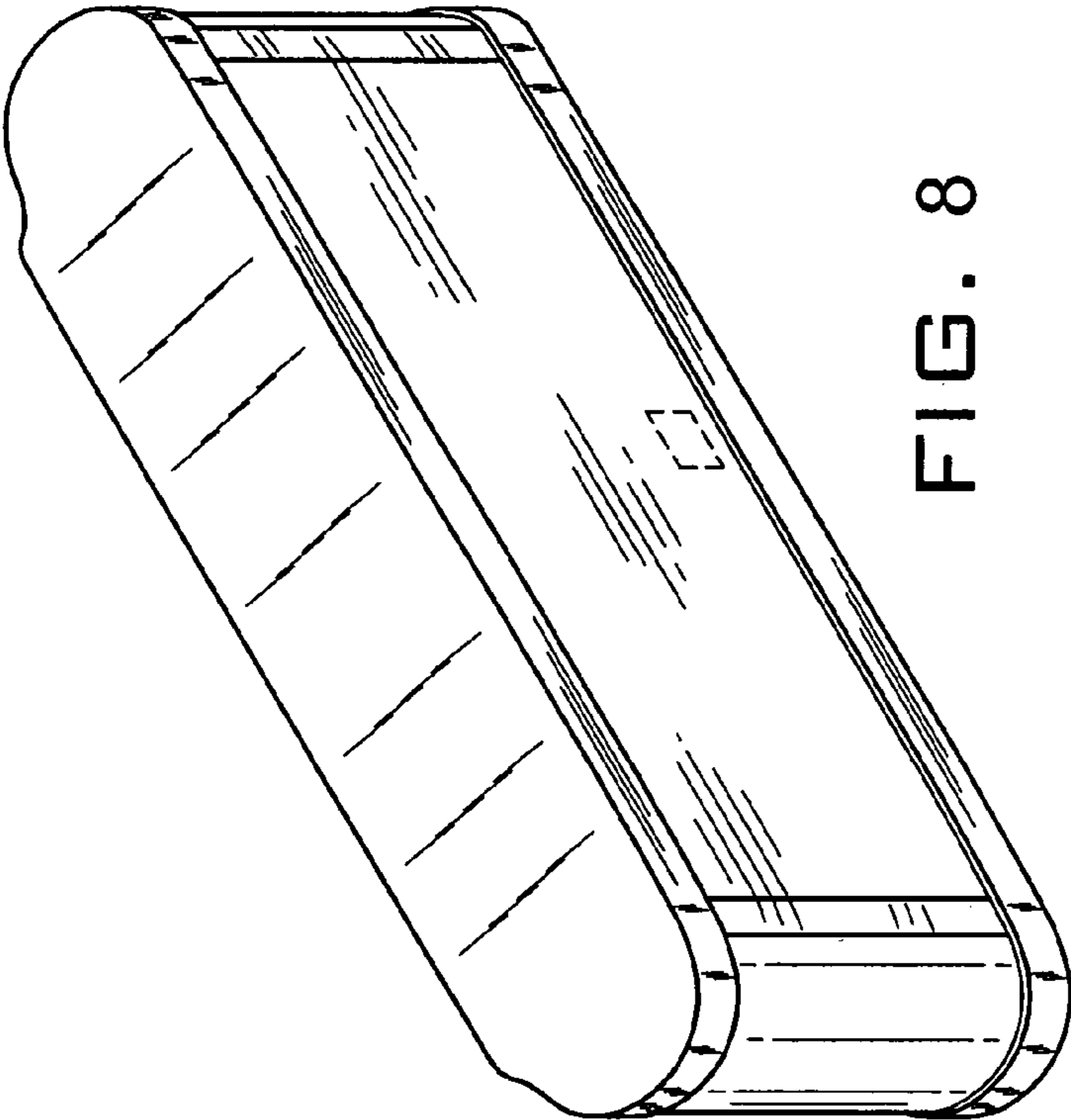

FIG. 8

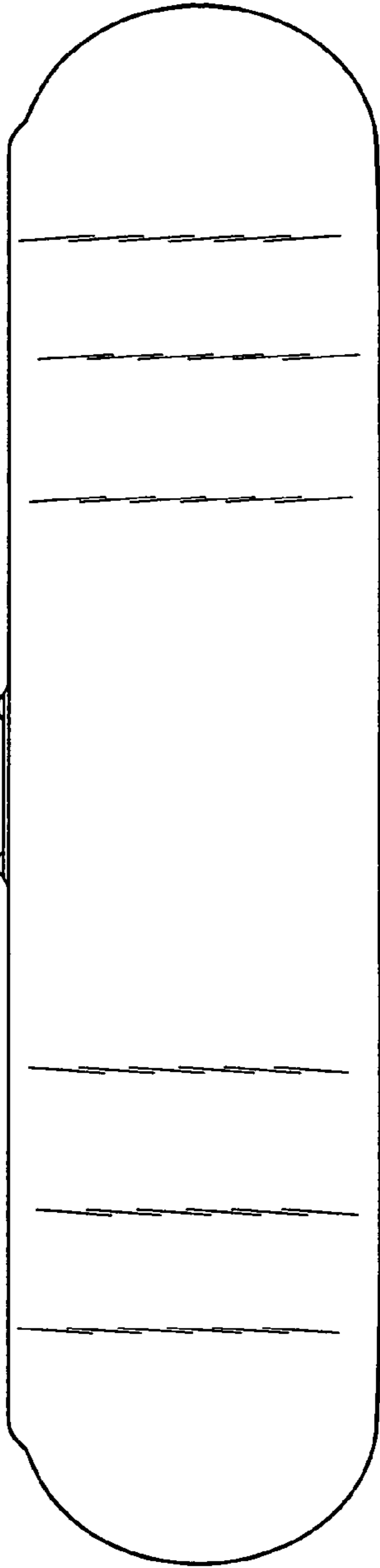

FIG. 9

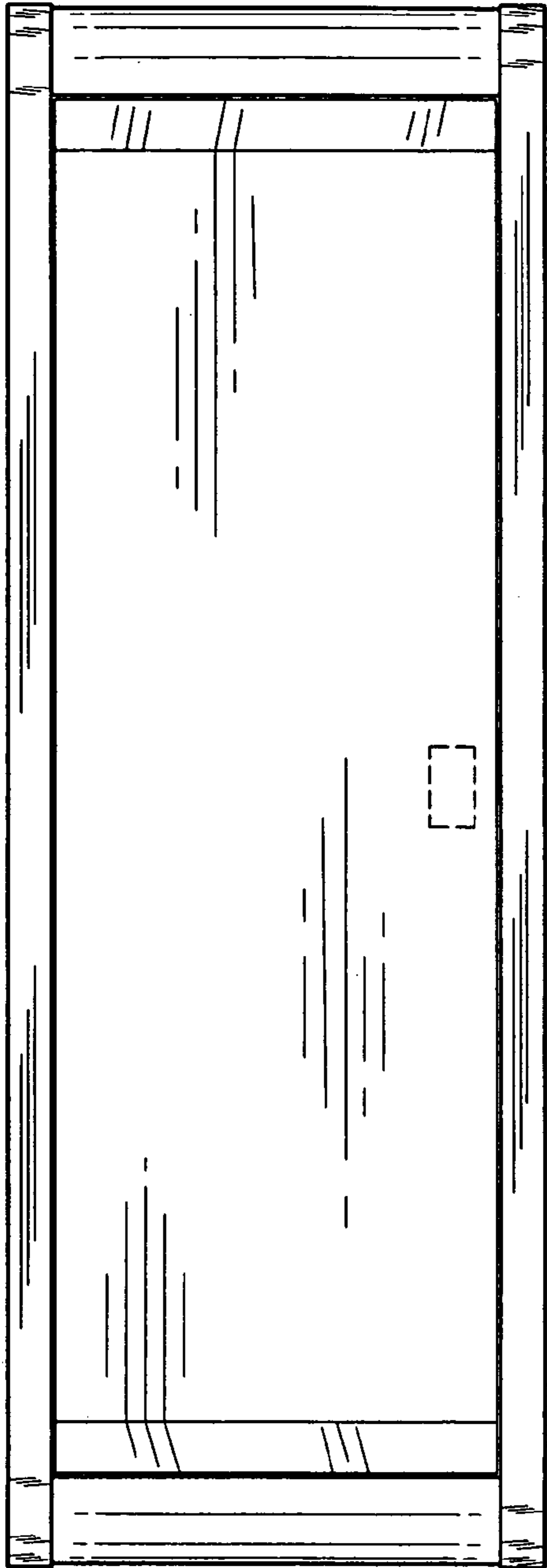

FIG. 10

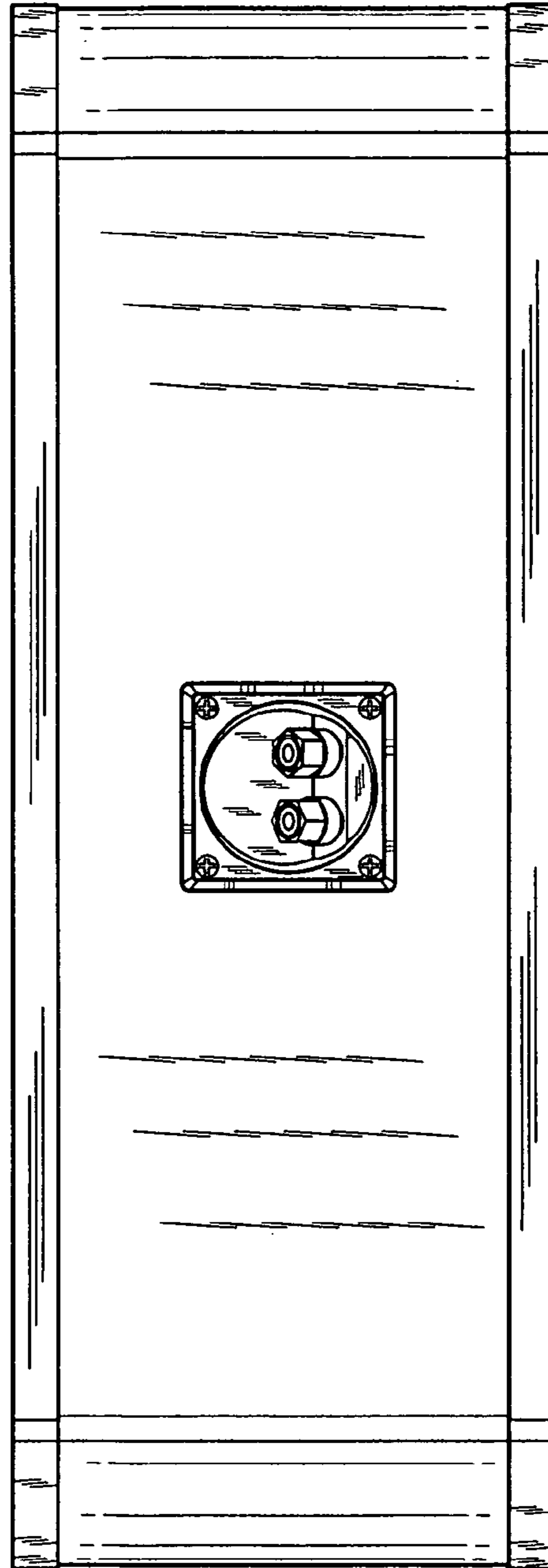

FIG. 11

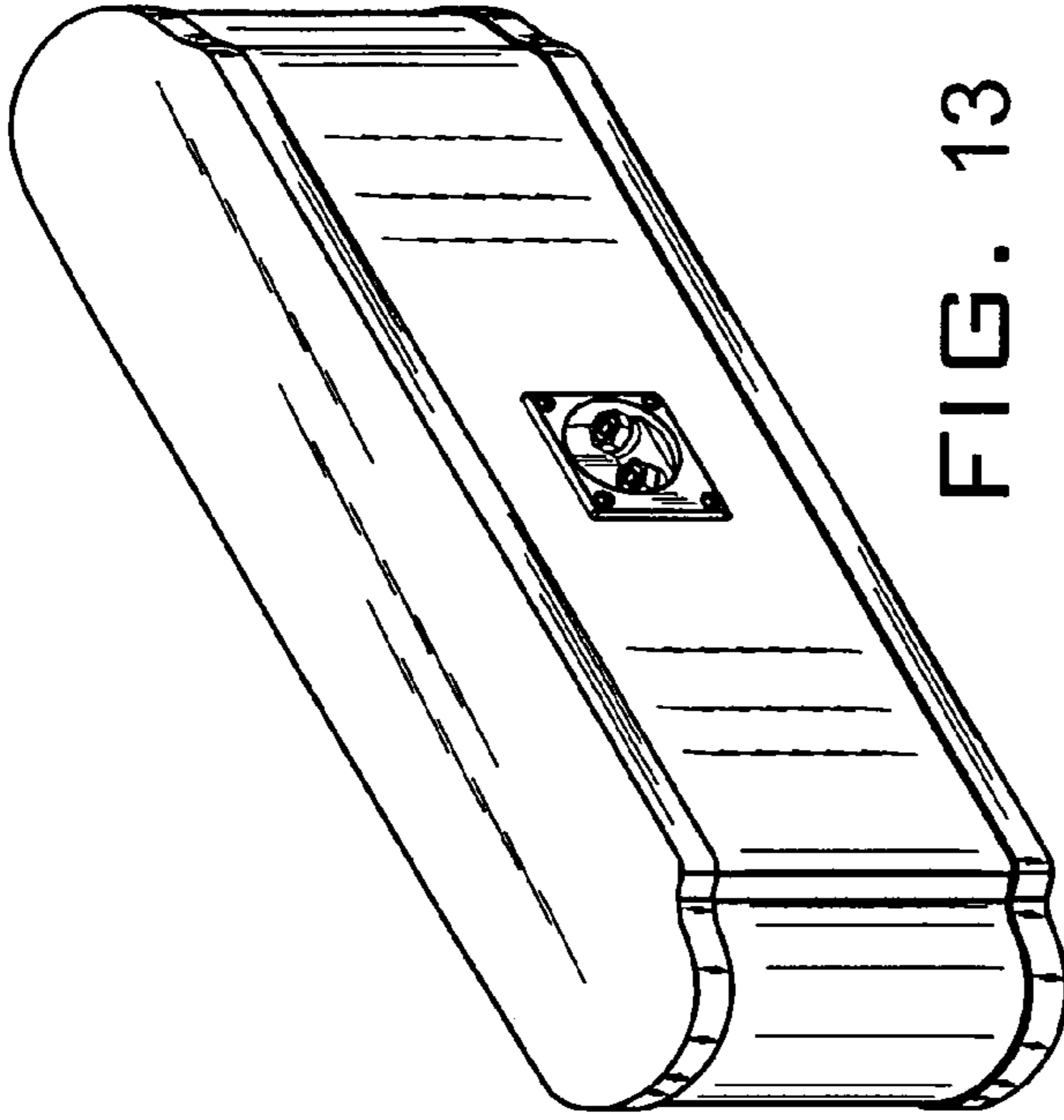

FIG. 13

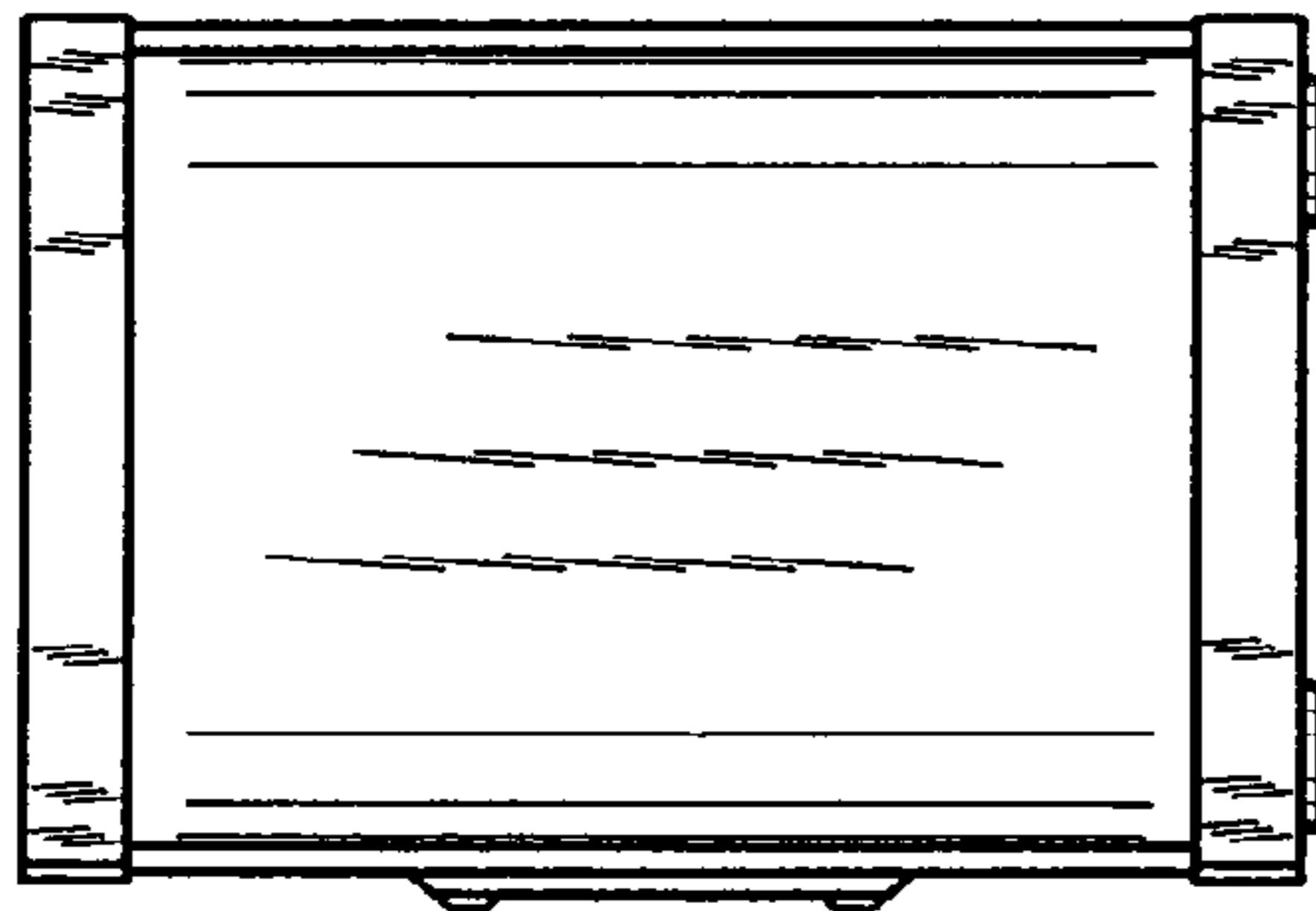

FIG. 12

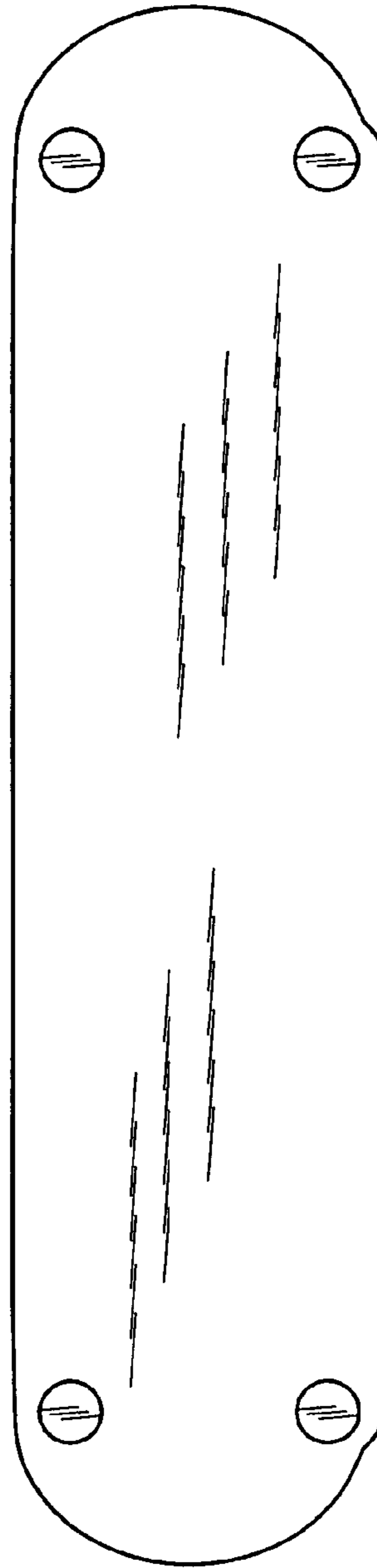

FIG. 14