



US00D546795S

(12) **United States Design Patent**  
**Kim et al.**

(10) **Patent No.:** **US D546,795 S**  
(45) **Date of Patent:** **\*\* Jul. 17, 2007**

(54) **PORTABLE PHONE**

(75) Inventors: **Young-Sae Kim**, Palo Alto, CA (US);  
**Chi-Young Ahn**, Seodaemun-Gu (KR);  
**Beom-Ku Han**, Seoul (KR);  
**Chang-Hwan Hwang**, Goyang-Si (KR)

(73) Assignee: **Samsung Electronics Co., Ltd.**,  
Suwon-Si (KR)

(\*\*) Term: **14 Years**

(21) Appl. No.: **29/234,742**

(22) Filed: **Jul. 22, 2005**

(30) **Foreign Application Priority Data**

Jan. 26, 2005 (KR) ..... 30-2005-0002643

(51) **LOC (8) Cl.** ..... **14-03**

(52) **U.S. Cl.** ..... **D14/138**

(58) **Field of Classification Search** ..... D14/191,  
D14/138, 147-148, 247-248, 144, 496, 156,  
D14/341-347; 379/433.01-433.13; 455/575.3,  
455/566, 575.1, 556.1, 556.2, 90.3; D21/517;  
D16/208

See application file for complete search history.

(56) **References Cited**

**U.S. PATENT DOCUMENTS**

- D382,556 S \* 8/1997 Jeong ..... D14/138
- D484,863 S \* 1/2004 Chan ..... D14/138
- D500,480 S \* 1/2005 Daw ..... D14/138
- D506,737 S \* 6/2005 Koo et al. .... D14/138
- D508,037 S \* 8/2005 Joung ..... D14/138
- D508,475 S \* 8/2005 Wu et al. .... D14/138
- D510,922 S \* 10/2005 Kim et al. .... D14/138
- D511,336 S \* 11/2005 Kim et al. .... D14/138
- D512,398 S \* 12/2005 Chen et al. .... D14/138
- D512,975 S \* 12/2005 Tsai et al. .... D14/138
- D518,463 S \* 4/2006 Tan et al. .... D14/138
- D519,966 S \* 5/2006 Salmi et al. .... D14/138
- D519,973 S \* 5/2006 Chung et al. .... D14/138

- D526,983 S \* 8/2006 Gong et al. .... D14/138
- D528,097 S \* 9/2006 Kim ..... D14/138
- 7,110,797 B2 \* 9/2006 Soejima ..... 455/575.1
- 7,130,669 B2 \* 10/2006 Moon ..... 455/575.3
- D531,607 S \* 11/2006 Kim et al. .... D14/138
- 2004/0048632 A1 \* 3/2004 Kuroda ..... 455/550.1

(Continued)

**FOREIGN PATENT DOCUMENTS**

- WO DM/067683 \* 3/2006
- WO DM/067695 \* 3/2006

**OTHER PUBLICATIONS**

NEC 802 telephone, announced 3rd Q 2004, [online], [retrieved on Jan. 22, 2007]. Retrieved from Internet ,<URL:http://www.gsmarena.com>.\*  
Samsung SPH-P9000 telephone, posted Nov. 8, 2006, [online], [retrieved on Feb. 4, 2007]. Retrieved from Internet ,<URL:http://www.mobiletechnews.com>.\*

*Primary Examiner*—Jeffrey Asch

(74) *Attorney, Agent, or Firm*—Staas & Halsey LLP

(57) **CLAIM**

The ornamental design for the portable phone, as shown and described.

**DESCRIPTION**

FIG. 1 is a perspective view of the portable phone showing our design;

FIG. 2 is a front view thereof;

FIG. 3 is a rear view thereof;

FIG. 4 is a left side view thereof;

FIG. 5 is a right side view thereof;

FIG. 6 is a top plan view thereof;

FIG. 7 is a bottom plan view thereof; and,

FIG. 8 is an open view thereof with the display rotated to an alternate position.

**1 Claim, 5 Drawing Sheets**

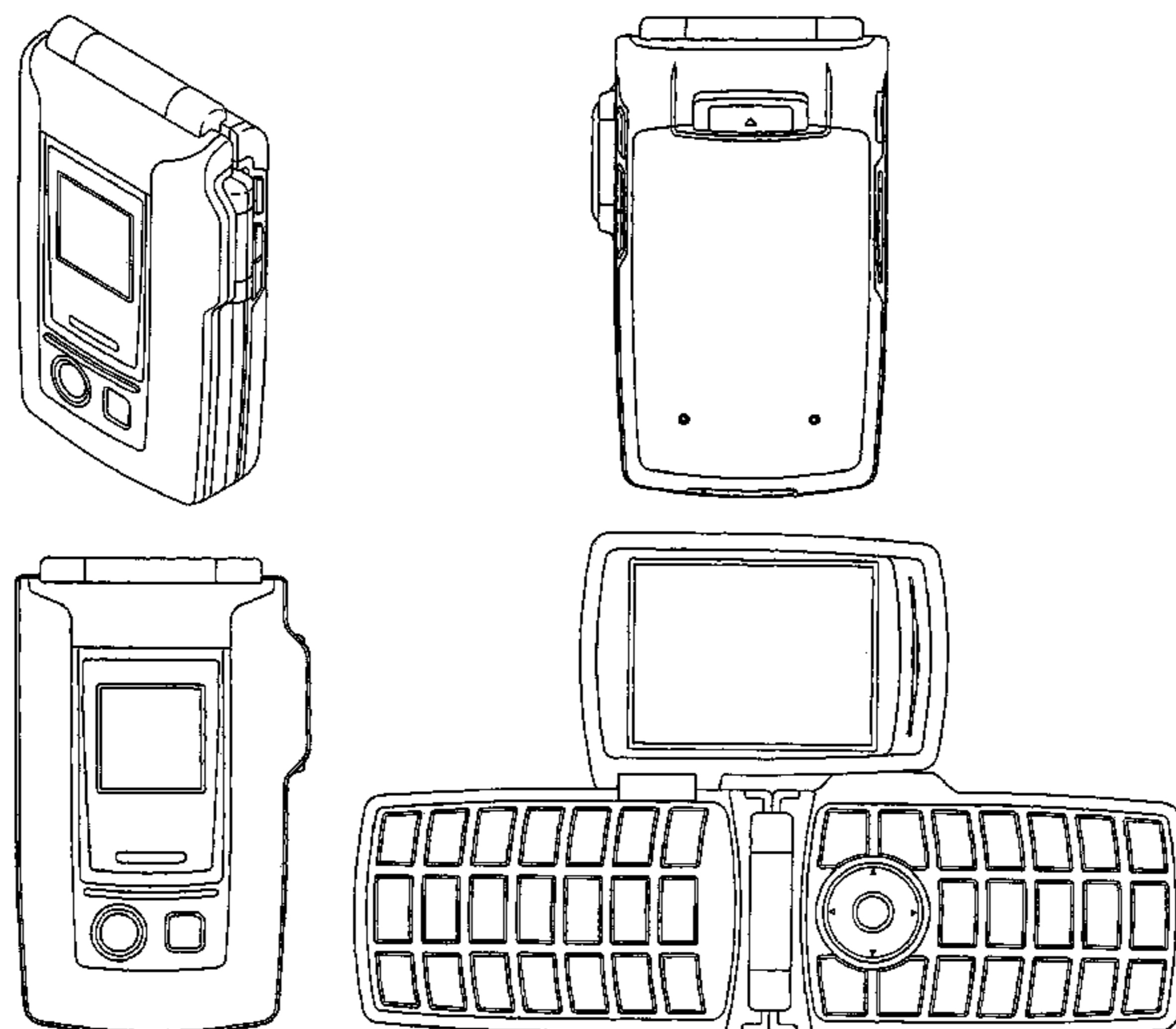

# US D546,795 S

Page 2

---

## U.S. PATENT DOCUMENTS

2004/0142734	A1*	7/2004	Kim .....	455/575.1	2006/0019614	A1*	1/2006	Yamasaki .....	455/90.2
2004/0203513	A1*	10/2004	Kwon .....	455/90.3	2006/0135222	A1*	6/2006	Kim .....	455/575.1
2005/0026658	A1*	2/2005	Soejima .....	455/575.1	2006/0229117	A1*	10/2006	Lehtonen .....	455/575.3
2005/0148375	A1*	7/2005	DeLine .....	455/575.3	2006/0256960	A1*	11/2006	Bae et al. ....	379/433.11

\* cited by examiner

**FIG. 1**

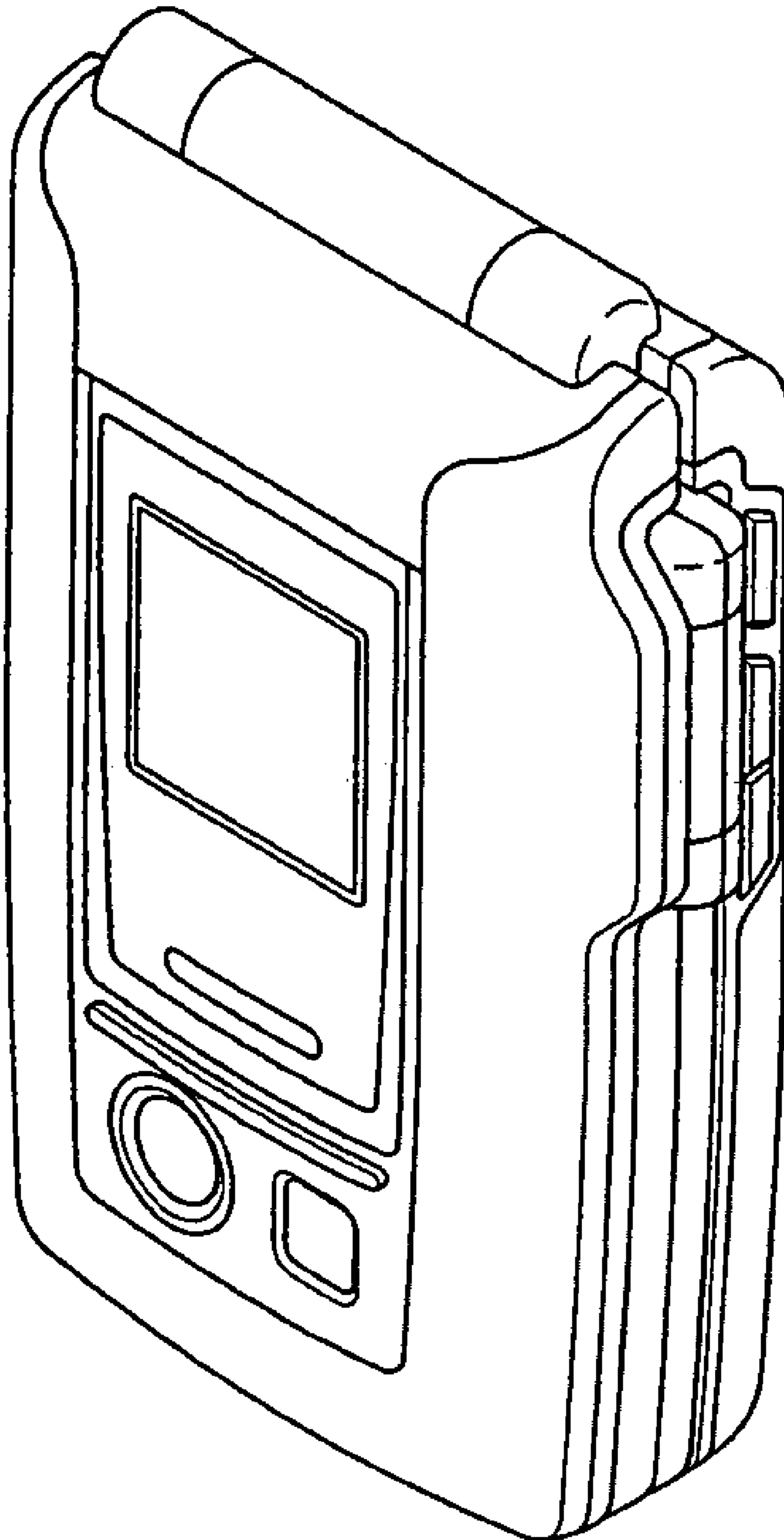

**FIG. 2**

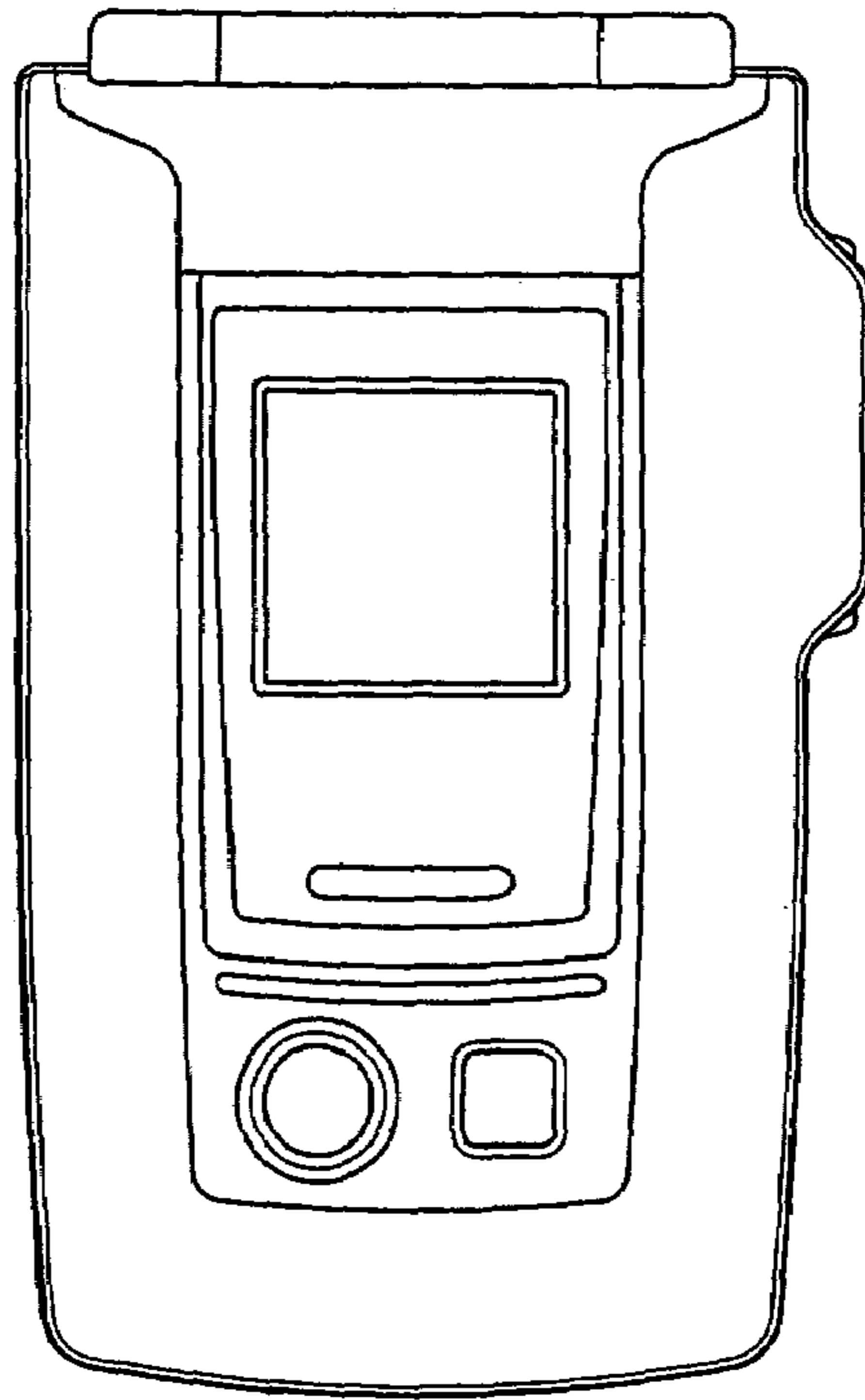

**FIG. 3**

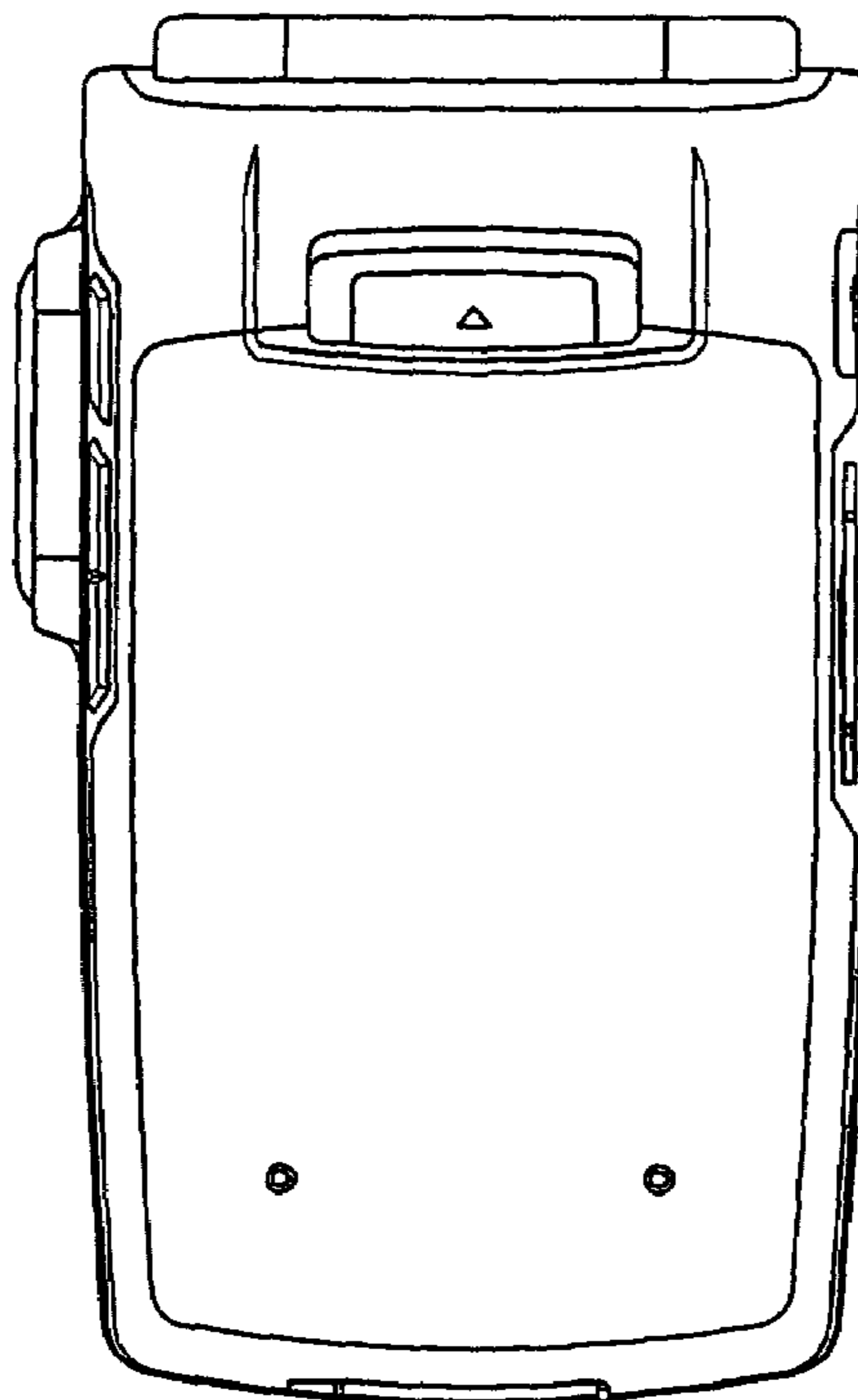

**FIG. 4**

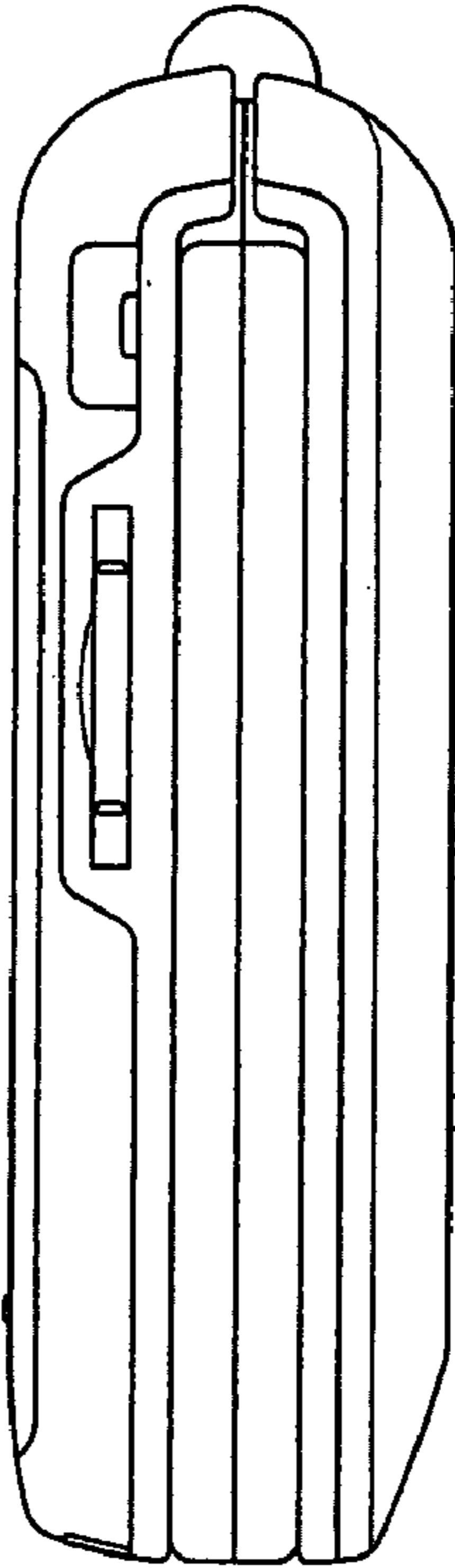

**FIG. 5**

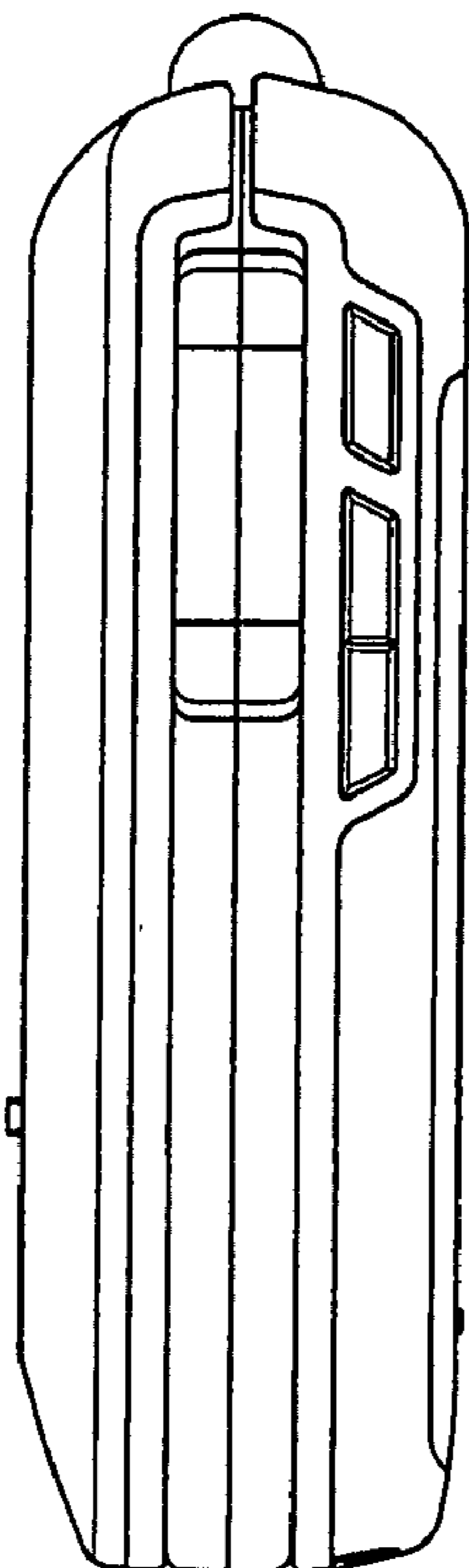

**FIG. 6**

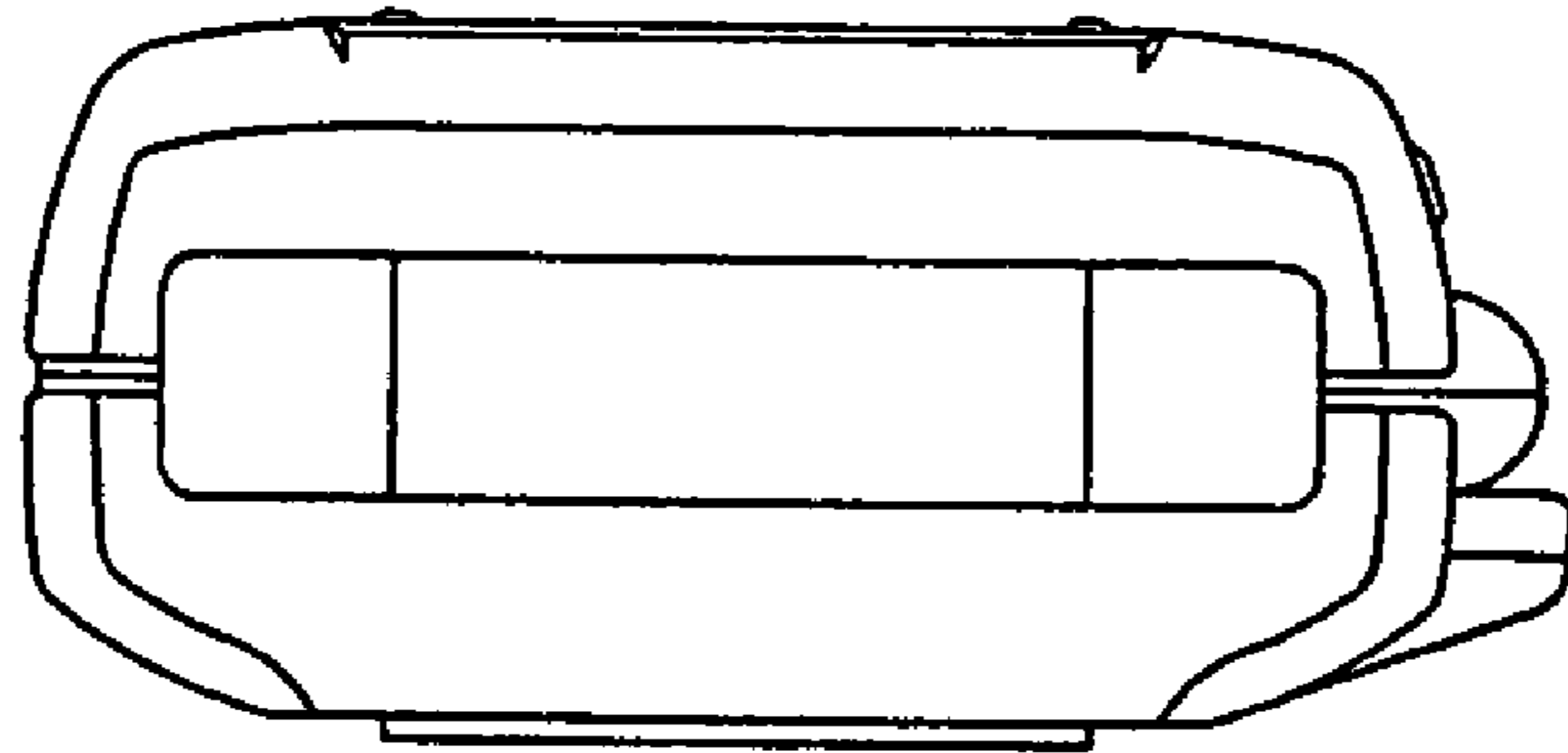

**FIG. 7**

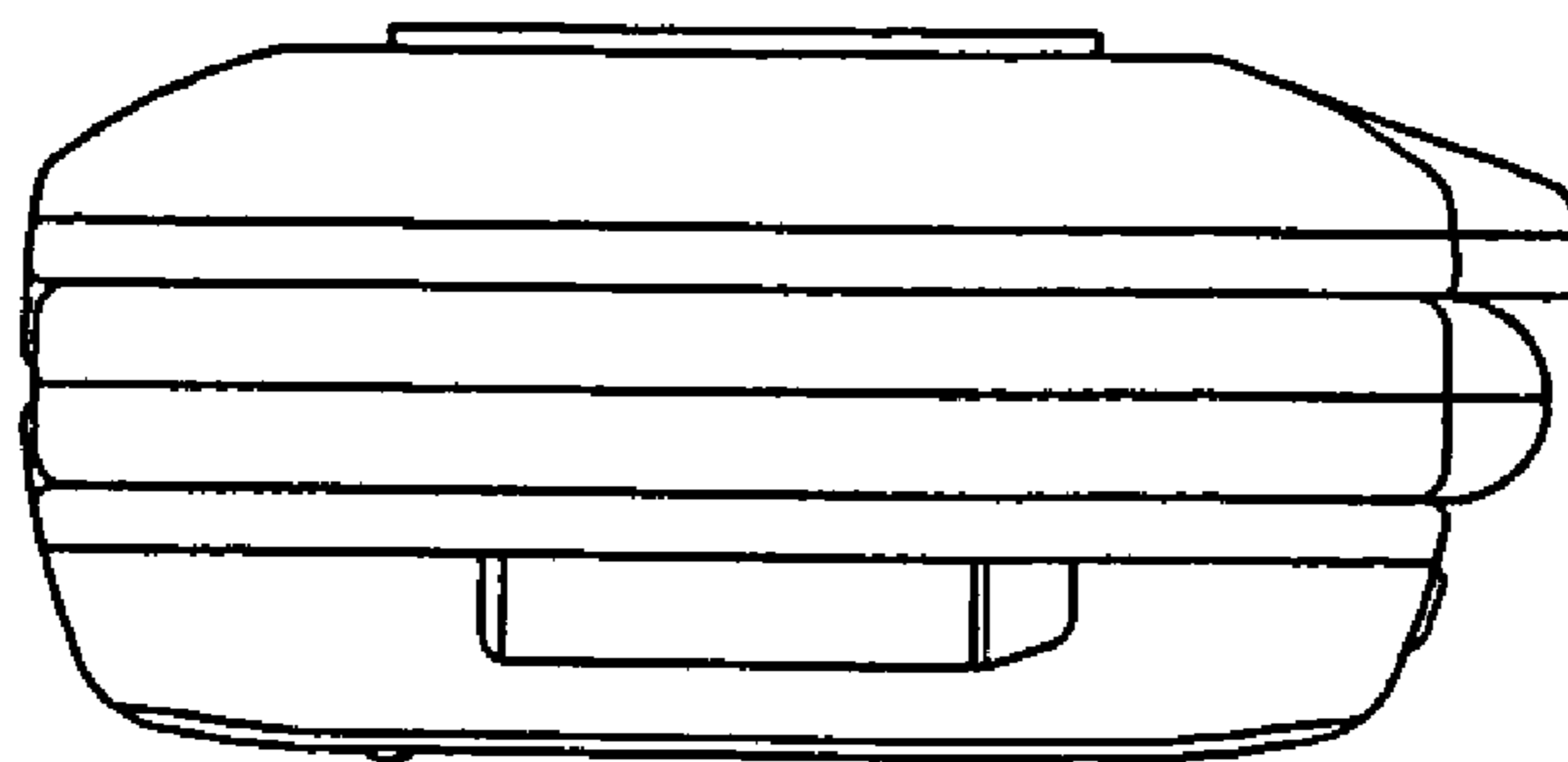

FIG. 8

