

US00D546791S

(12) **United States Design Patent**
Liang et al.

(10) **Patent No.:** **US D546,791 S**

(45) **Date of Patent:** **** Jul. 17, 2007**

(54) **DIGITAL VIDEO DISK PLAYER**

(75) Inventors: **Li-Ni Liang**, Shenzhen (CN); **Wen-Jie Bao**, Shenzhen (CN)

(73) Assignee: **Hon Hai Precision Industry Co. Ltd.**, Tu-Cheng, Taipei Hsien (TW)

(**) Term: **14 Years**

(21) Appl. No.: **29/237,178**

(22) Filed: **Aug. 26, 2005**

(30) **Foreign Application Priority Data**

Apr. 22, 2005 (CN) 2005 3 0057823

(51) **LOC (8) Cl.** **14-03**

(52) **U.S. Cl.** **D14/129; D14/126**

(58) **Field of Classification Search** D14/125, D14/129, 132, 136, 156, 374, 375; 348/180, 348/184, 325, 838; 341/12; 345/104, 133, 345/156, 168, 173, 87; 720/605, 669, 600, 720/655; 369/99, 197; 455/344, 345, 346, 455/347, 566; 368/12

See application file for complete search history.

(56) **References Cited**

U.S. PATENT DOCUMENTS

- D405,781 S * 2/1999 Renk D14/126
- D415,147 S * 10/1999 Adachi D14/126
- D438,849 S * 3/2001 Adachi et al. D14/126
- D468,276 S * 1/2003 Chang D14/126

- D500,479 S * 1/2005 Senda et al. D14/130
- D502,152 S * 2/2005 Peng D14/126
- D502,452 S * 3/2005 Peng D14/126
- D503,160 S * 3/2005 Peng D14/129
- D506,733 S * 6/2005 Boyer, Jr. D14/126
- D518,007 S * 3/2006 Peng D14/129
- D518,010 S * 3/2006 Peng D14/129
- D519,956 S * 5/2006 Peng D14/129
- D521,956 S * 5/2006 Backs D14/126

* cited by examiner

Primary Examiner—Philip S. Hyder

(74) *Attorney, Agent, or Firm*—Jeffrey T. Knapp

(57) **CLAIM**

The ornamental design for a digital video disk player, as shown and described.

DESCRIPTION

FIG. 1 is a perspective view of a digital video disk player showing our new design;

FIG. 2 is a front view thereof;

FIG. 3 is a rear view thereof;

FIG. 4 is a left side elevational view thereof;

FIG. 5 is a right side elevational view thereof;

FIG. 6 is a top plan view thereof;

FIG. 7 is a bottom plan view thereof; and,

FIG. 8 is a perspective view thereof, wherein a support leg is in the unfolded position.

1 Claim, 6 Drawing Sheets

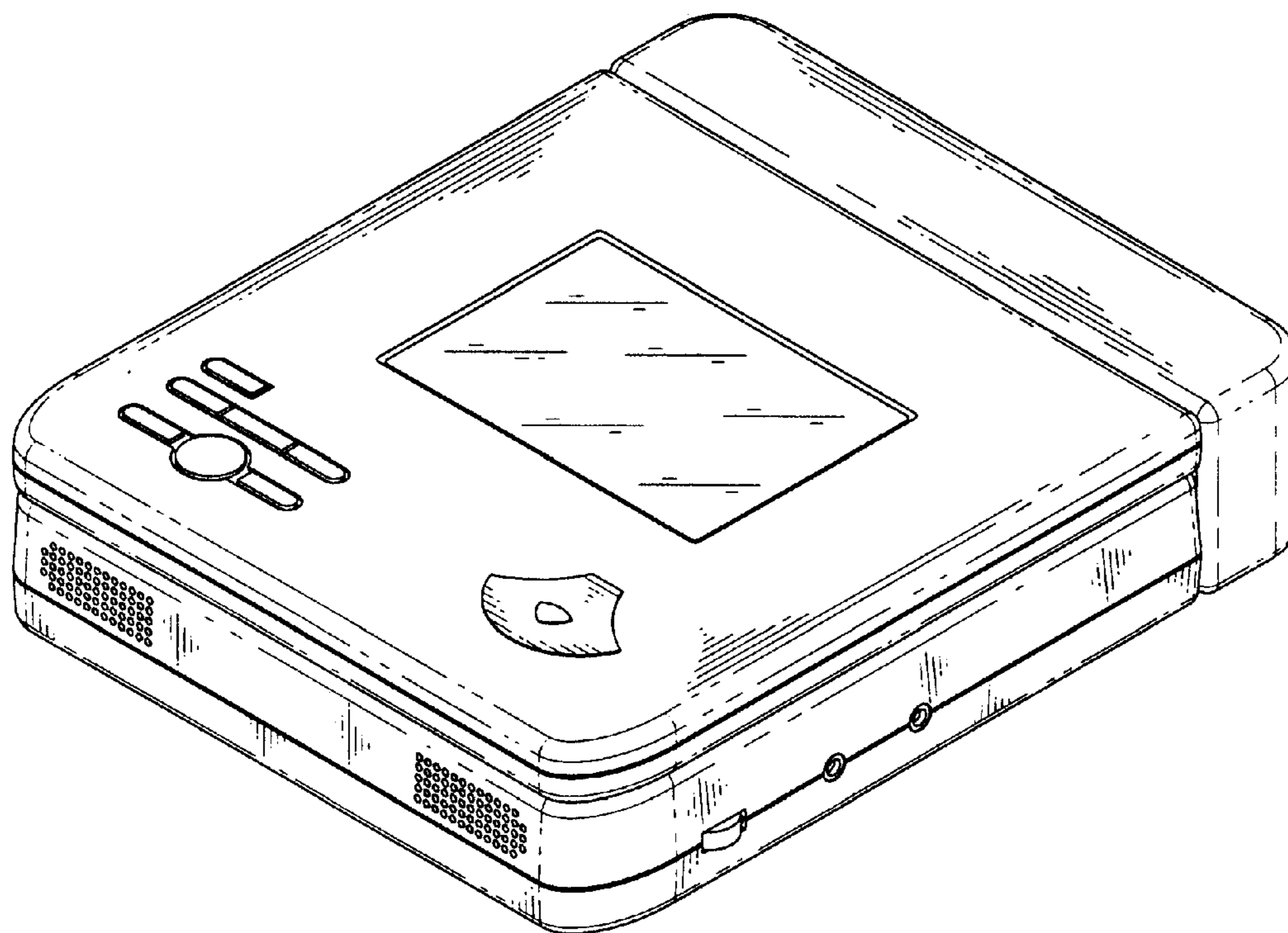

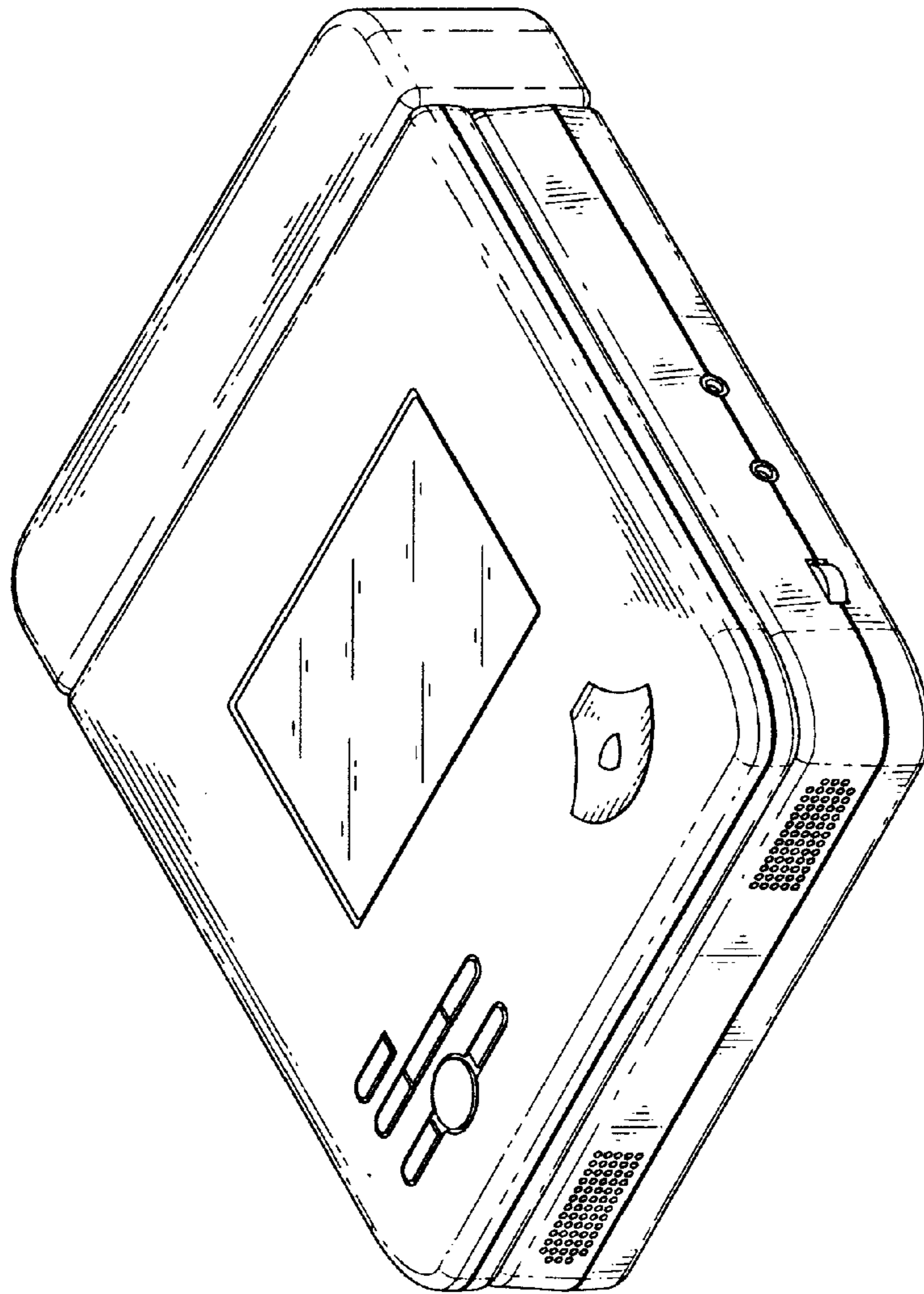

FIG. 1

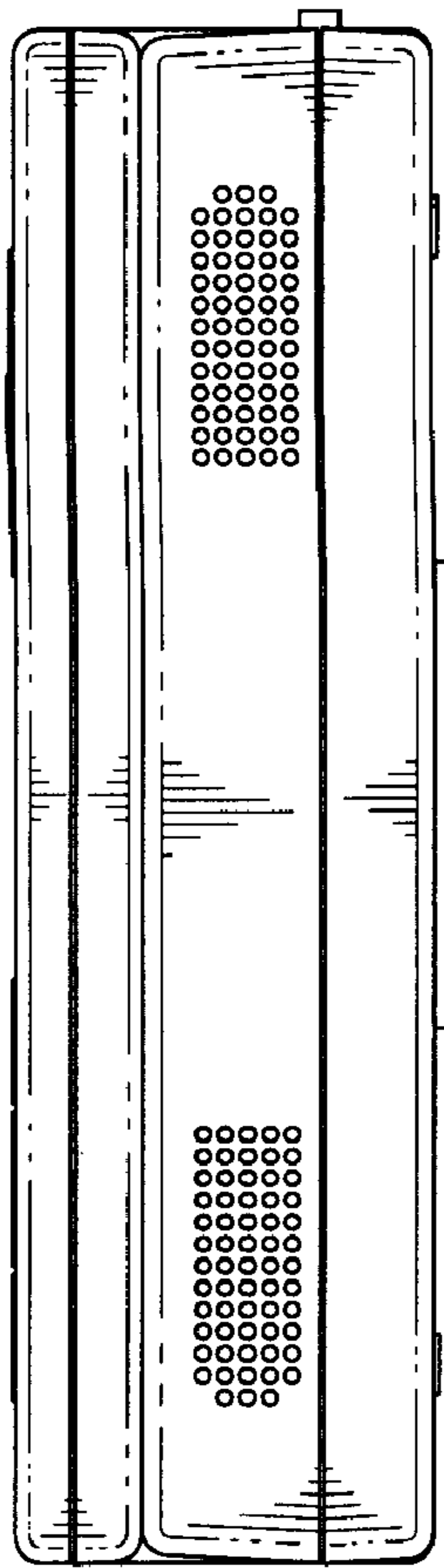

FIG. 2

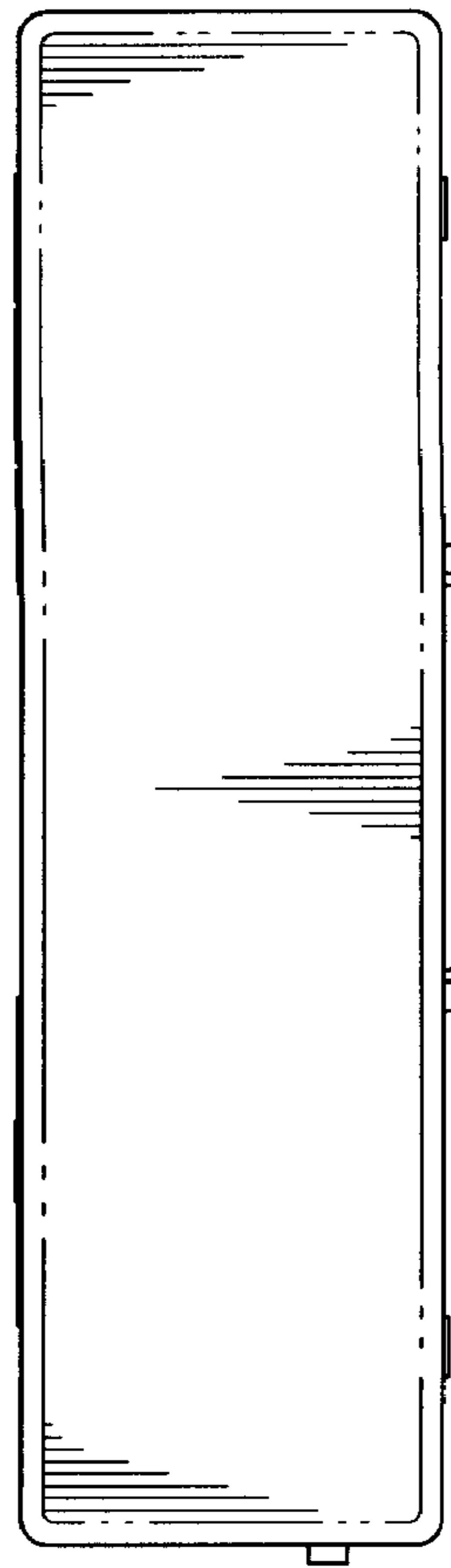

FIG. 3

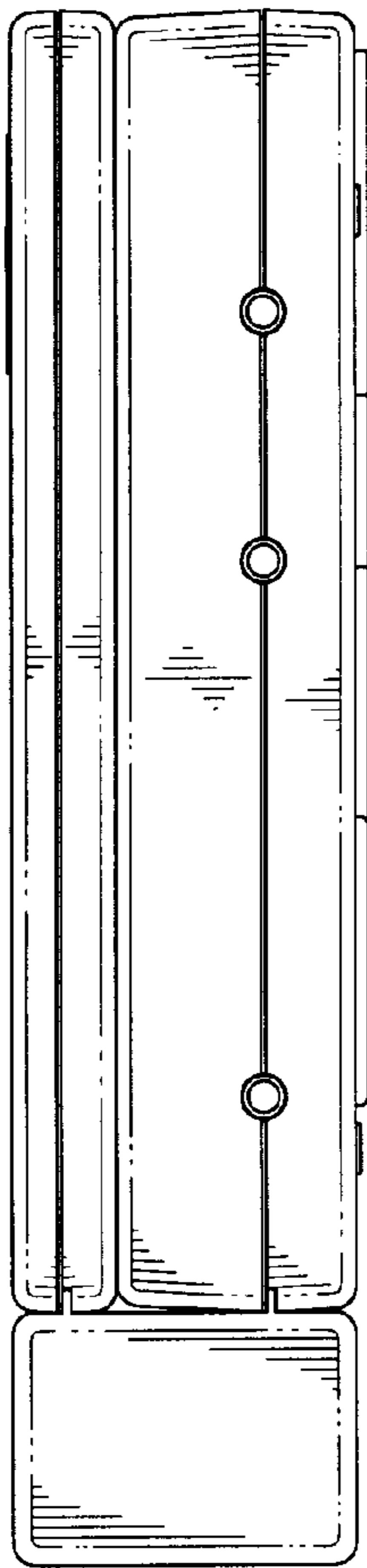

FIG. 4

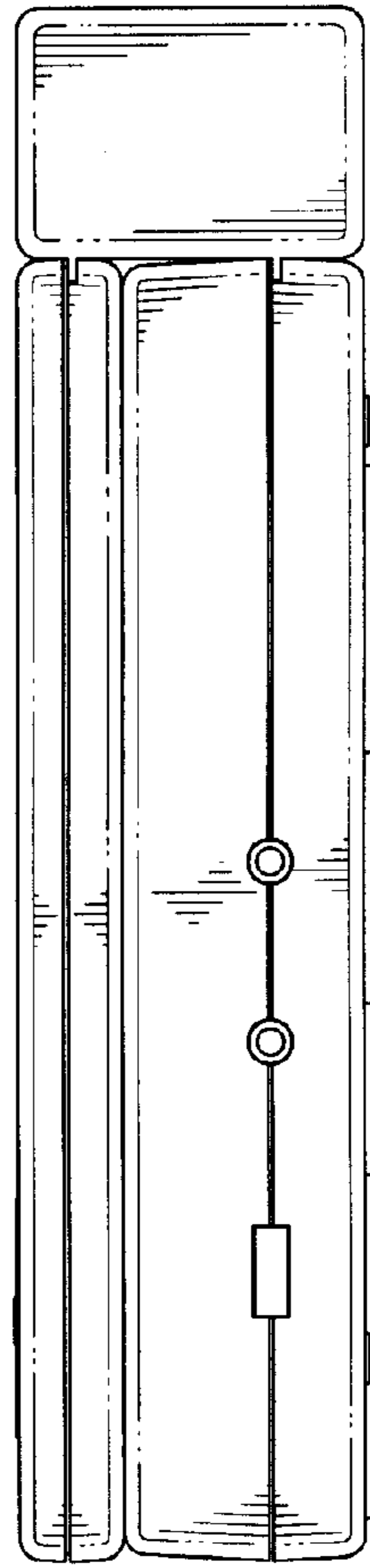

FIG. 5

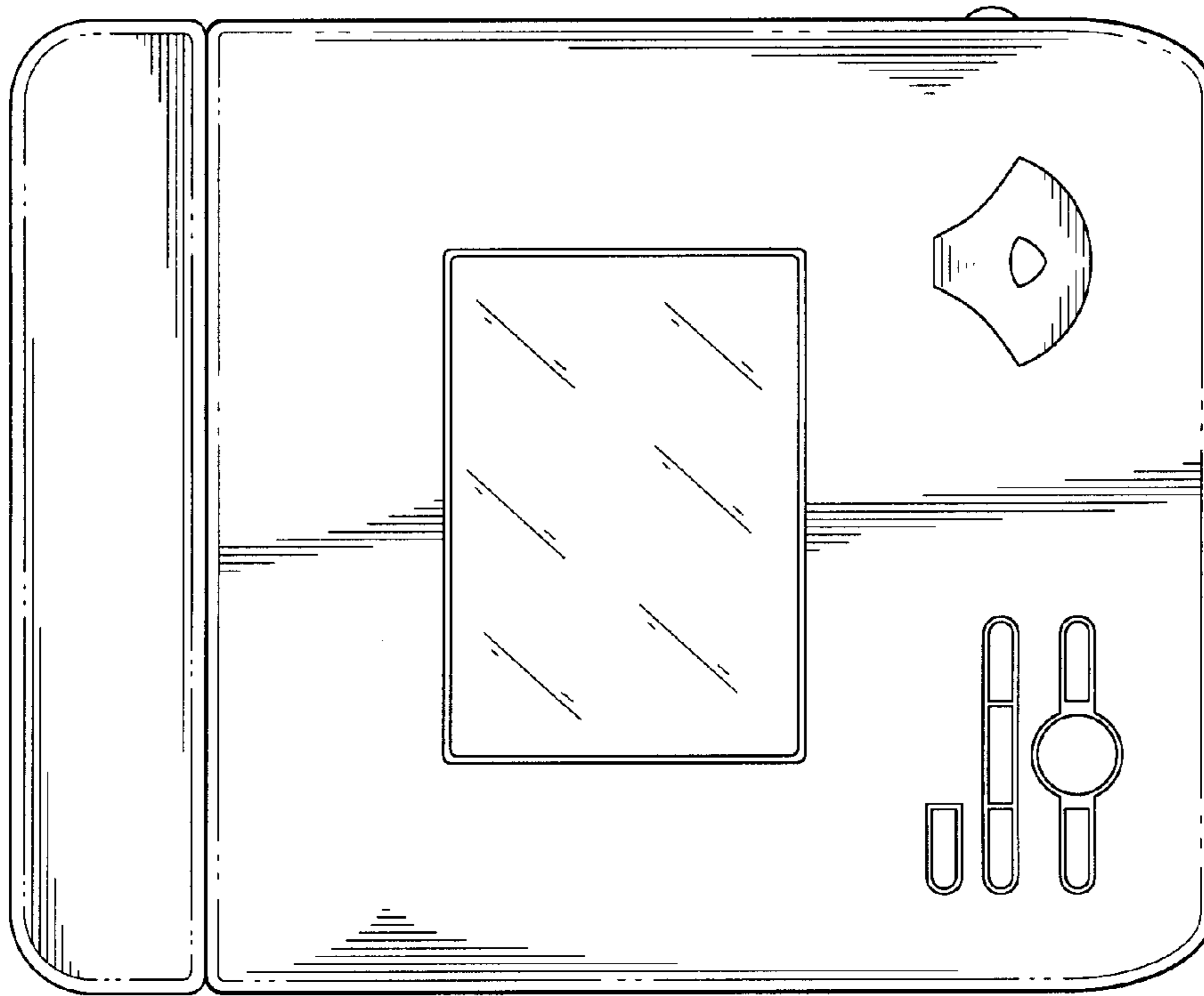

FIG. 6

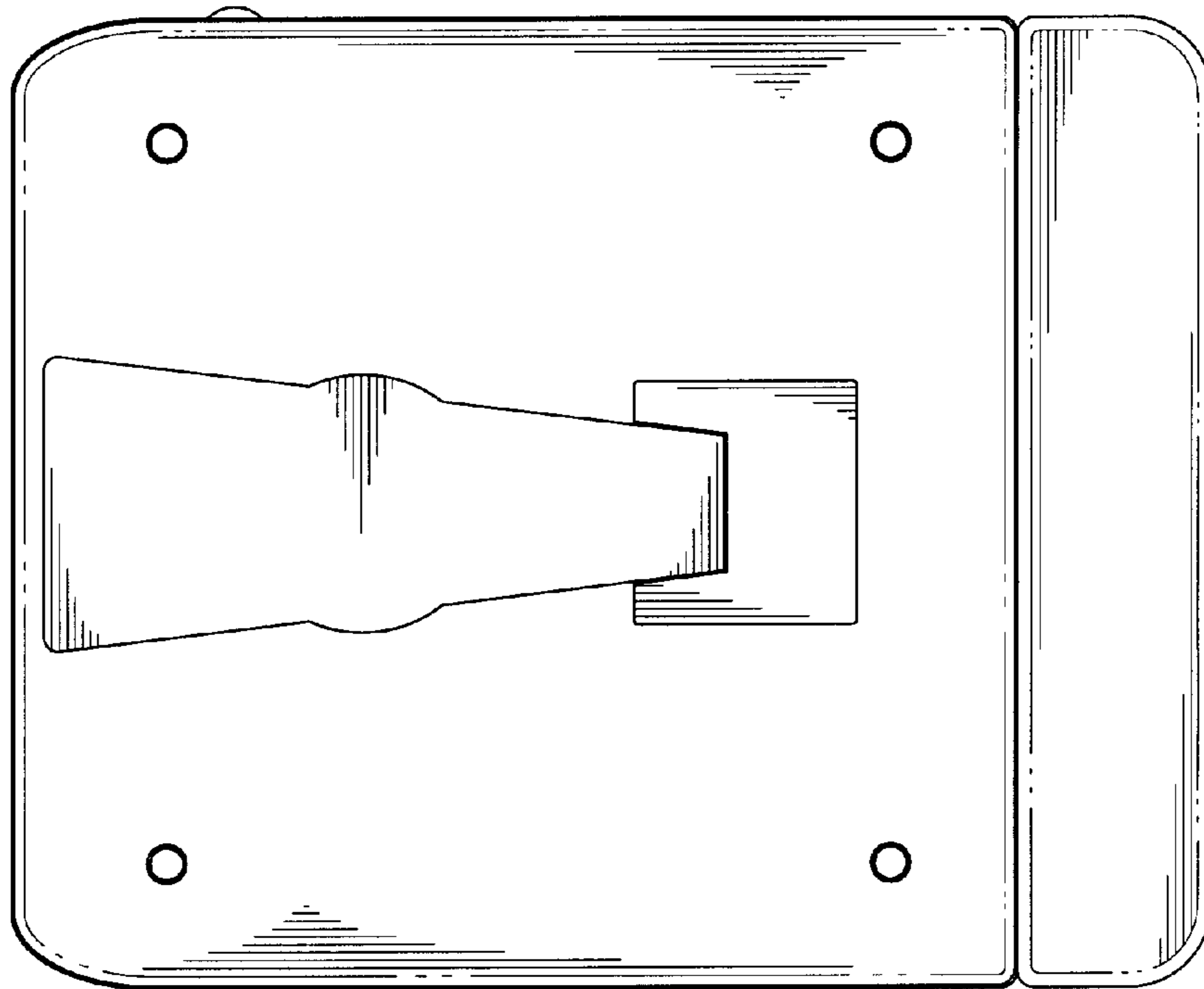

FIG. 7

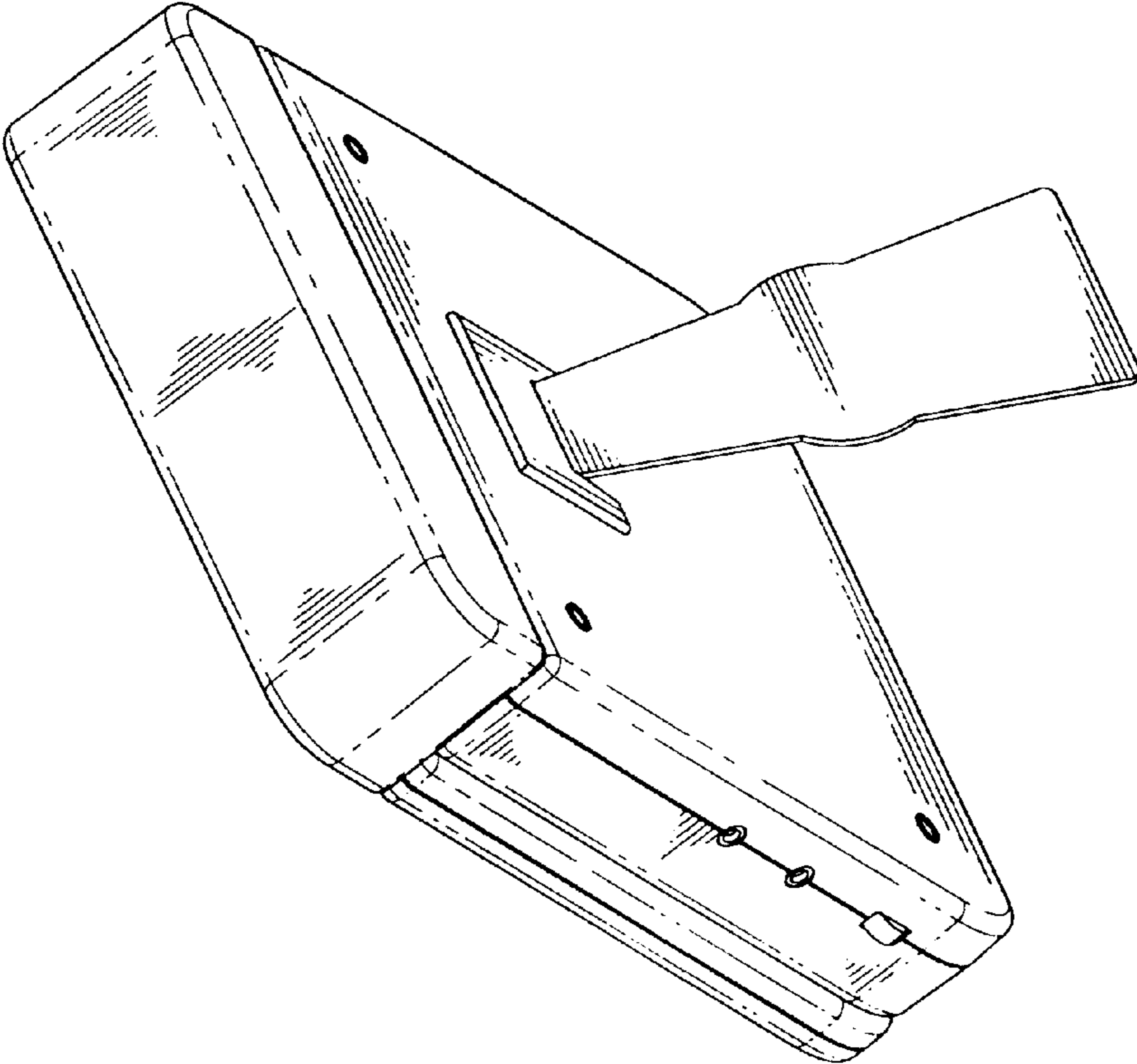

FIG. 8