

US00D546471S

(12) **United States Design Patent**  
**Wu**

(10) **Patent No.:** **US D546,471 S**

(45) **Date of Patent:** **\*\* Jul. 10, 2007**

(54) **CONTROL DEVICE**

(75) Inventor: **Wei Wu**, Huzhou (CN)

(73) Assignee: **Zhejiang Lover Health Science and Technology Development Co., Ltd.**, Zhejiang Province (CN)

(\*\*) Term: **14 Years**

(21) Appl. No.: **29/276,456**

(22) Filed: **Jan. 26, 2007**

(51) **LOC (8) Cl.** ..... **28-03**

(52) **U.S. Cl.** ..... **D24/215**

(58) **Field of Classification Search** ..... D24/211-215,  
D24/200, 143; 601/46, 101, 87, 84, 80, 70,  
601/85, 78, 67, DIG. 14, DIG. 16; 600/38;  
D13/168, 169, 170, 174

See application file for complete search history.

(56) **References Cited**

**U.S. PATENT DOCUMENTS**

- D346,219 S \* 4/1994 Fardigh ..... D24/143
- D496,333 S \* 9/2004 Nan ..... D13/103
- D536,797 S \* 2/2007 Klearman et al. .... D24/215
- 2002/0133102 A1\* 9/2002 Quan ..... 601/46

- 2006/0069329 A1\* 3/2006 Nan ..... D13/103
- 2006/0069330 A1\* 3/2006 Nan ..... 601/72

\* cited by examiner

*Primary Examiner*—Ian Simmons  
*Assistant Examiner*—Melanie Levy

(57) **CLAIM**

The ornamental design for a control device, as shown and described.

**DESCRIPTION**

The claimed control device is used for controlling the operation of massaging device.

FIG. 1 is a front elevational view of a control device showing my new design;

FIG. 2 is a rear elevational view thereof;

FIG. 3 is a right side view thereof;

FIG. 4 is a left side view thereof;

FIG. 5 is a top plan view thereof;

FIG. 6 is a bottom plan view thereof; and,

FIG. 7 is a perspective view thereof.

**1 Claim, 6 Drawing Sheets**

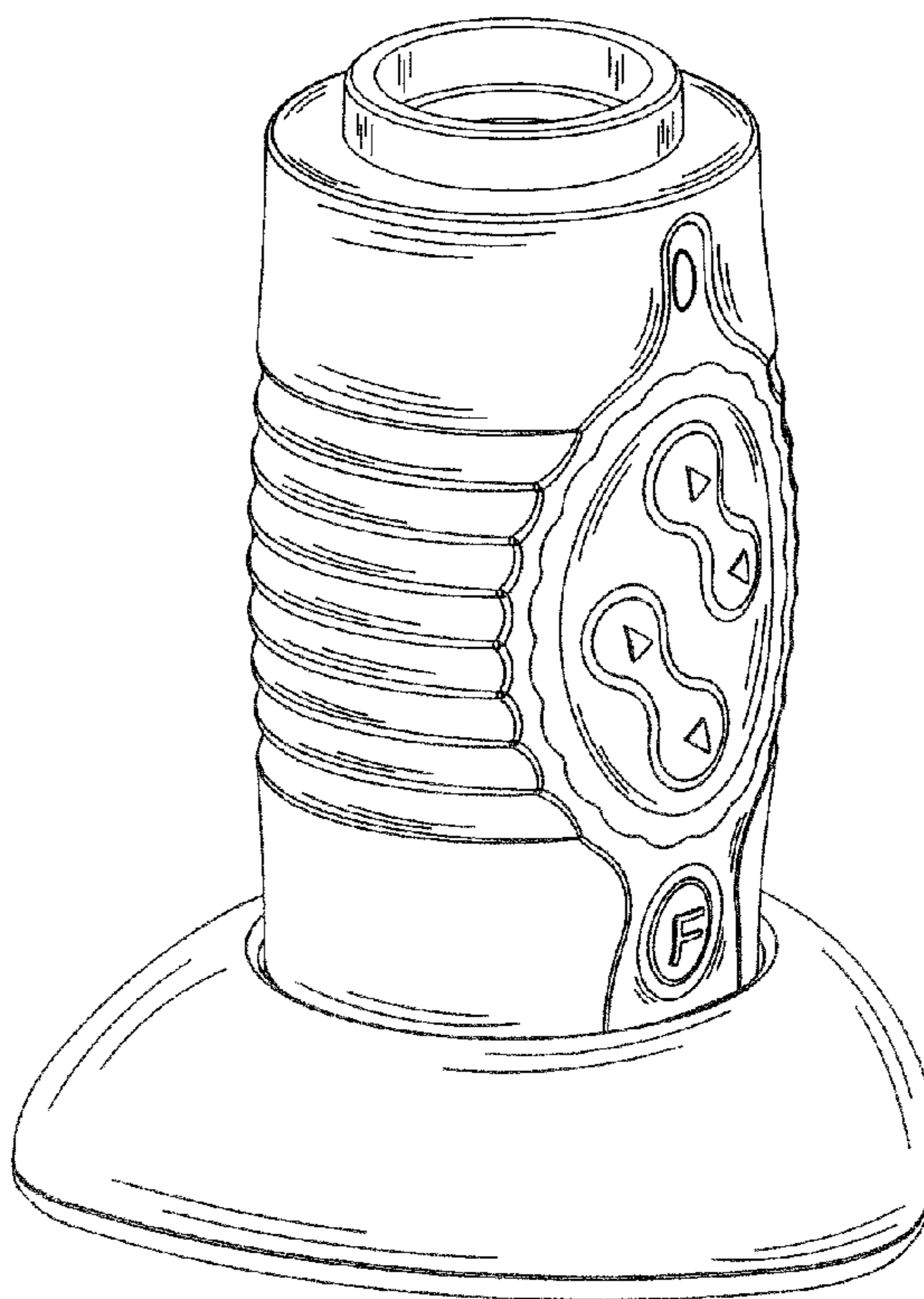
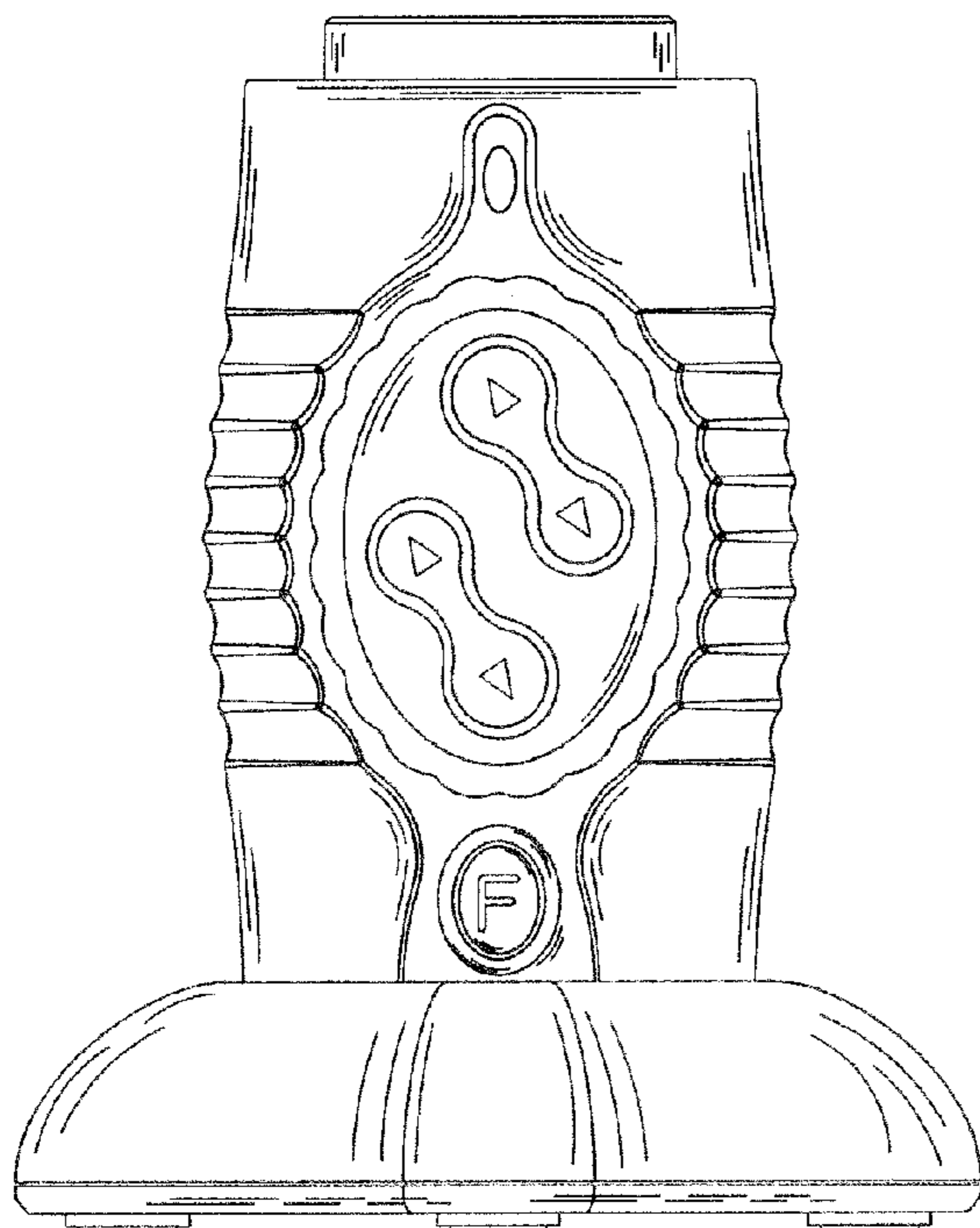

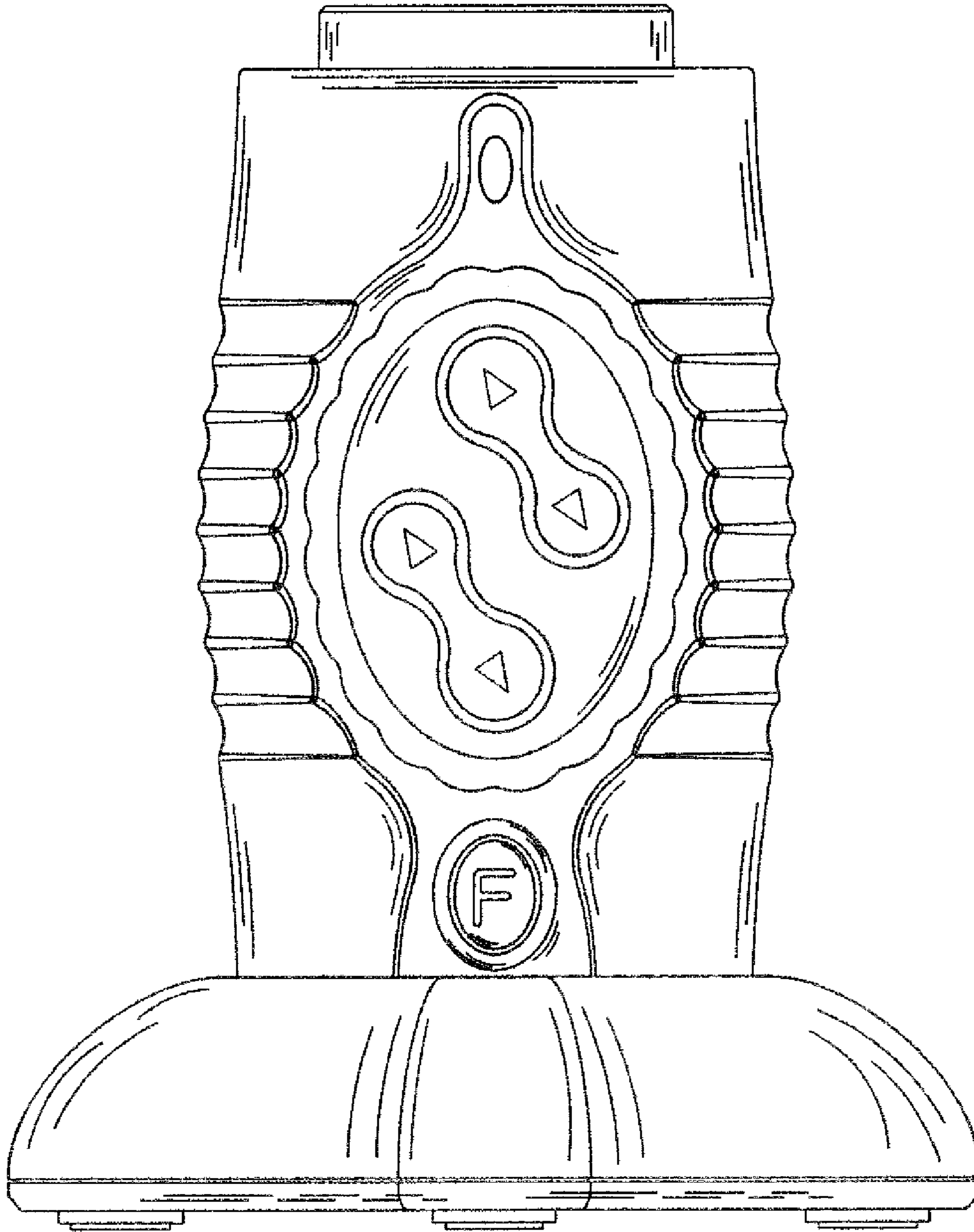

FIG. 1

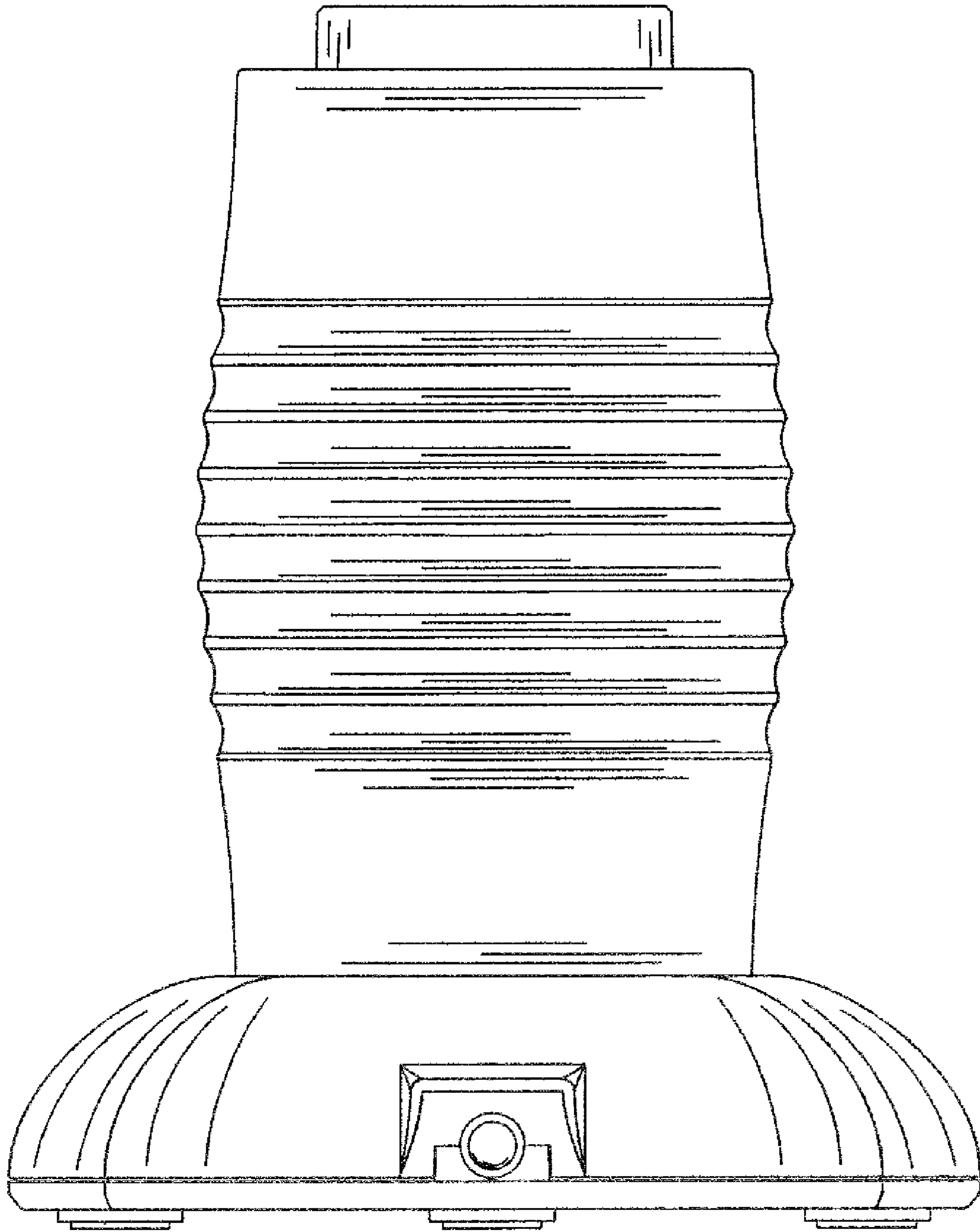

FIG. 2

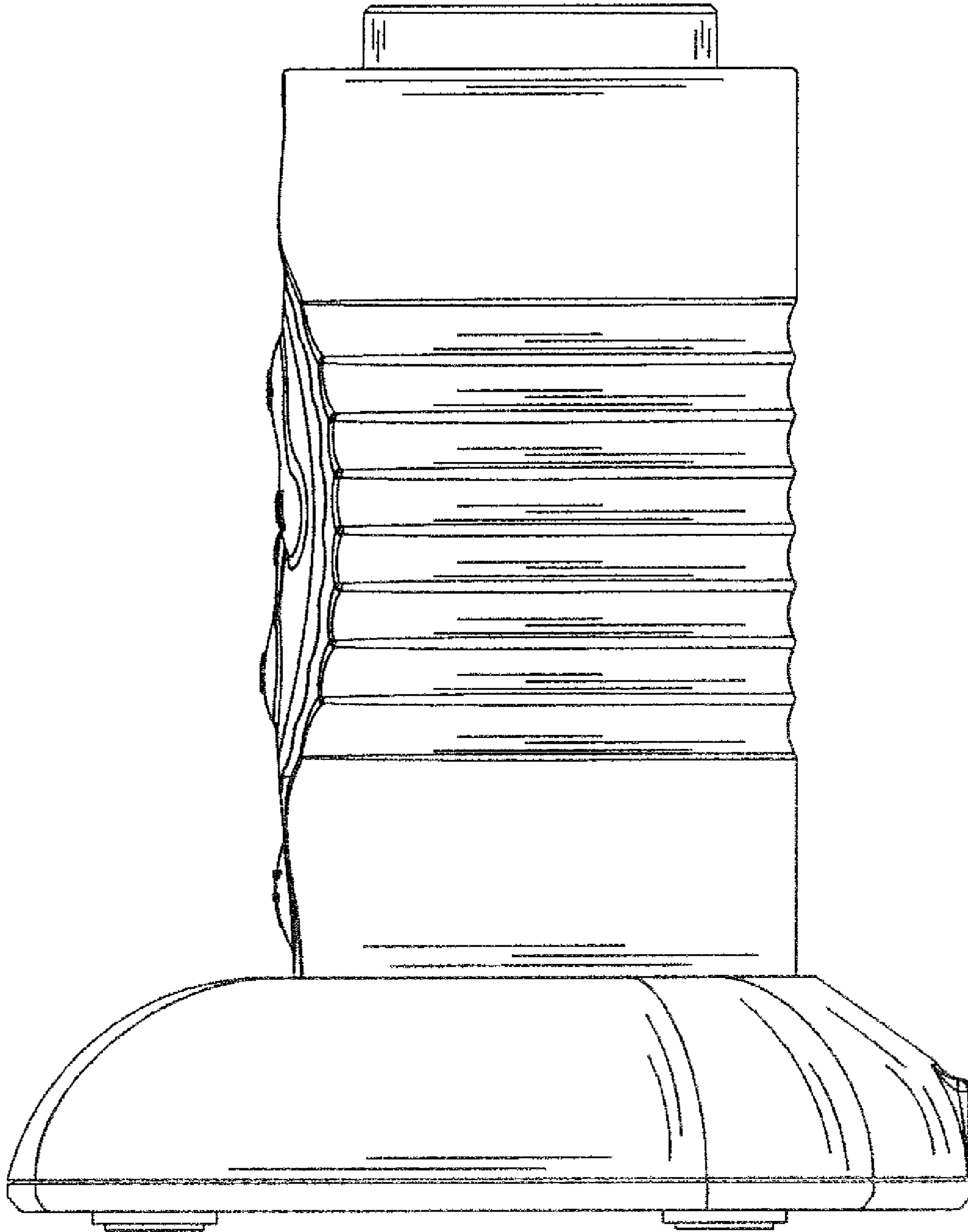

FIG. 3

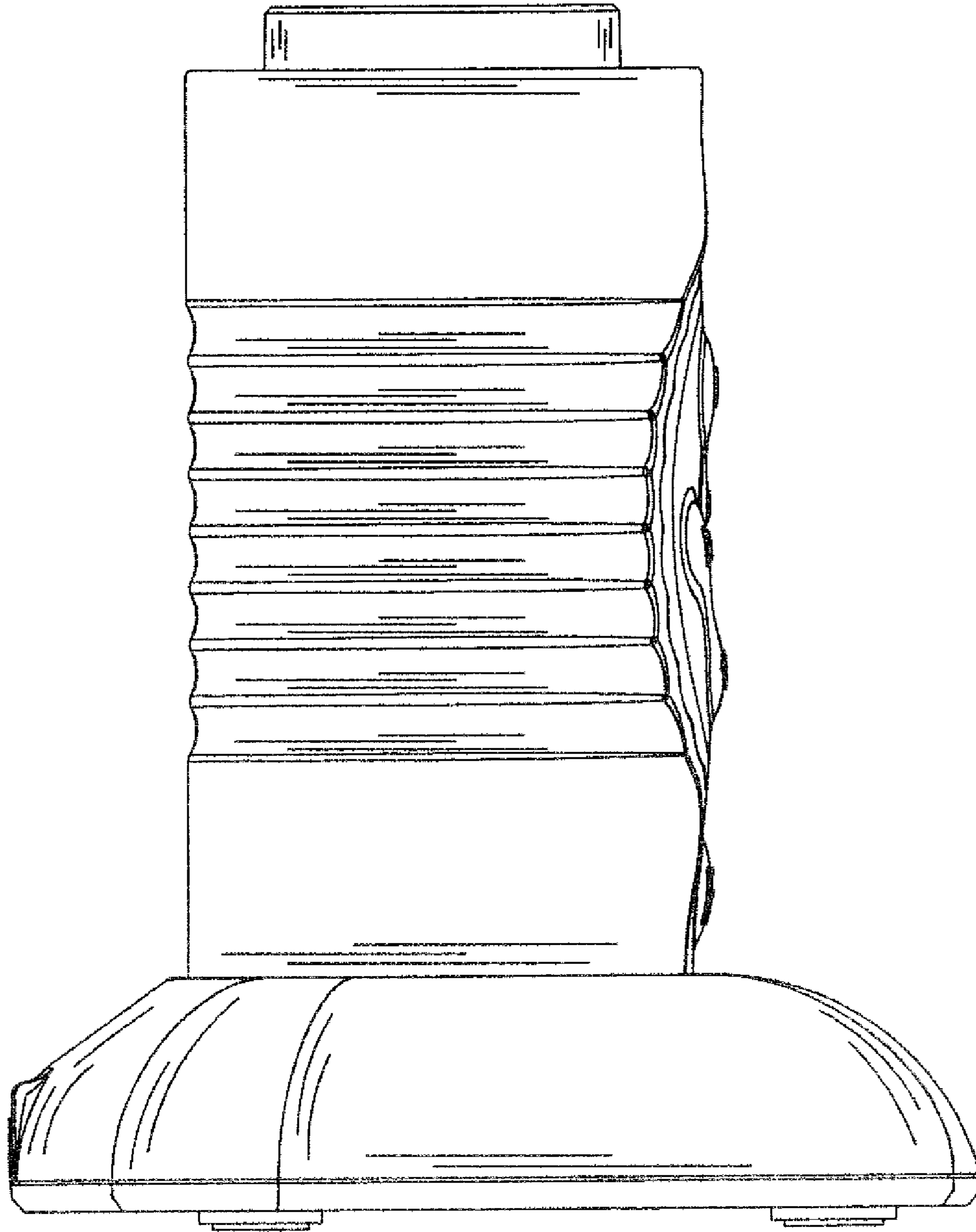

FIG. 4

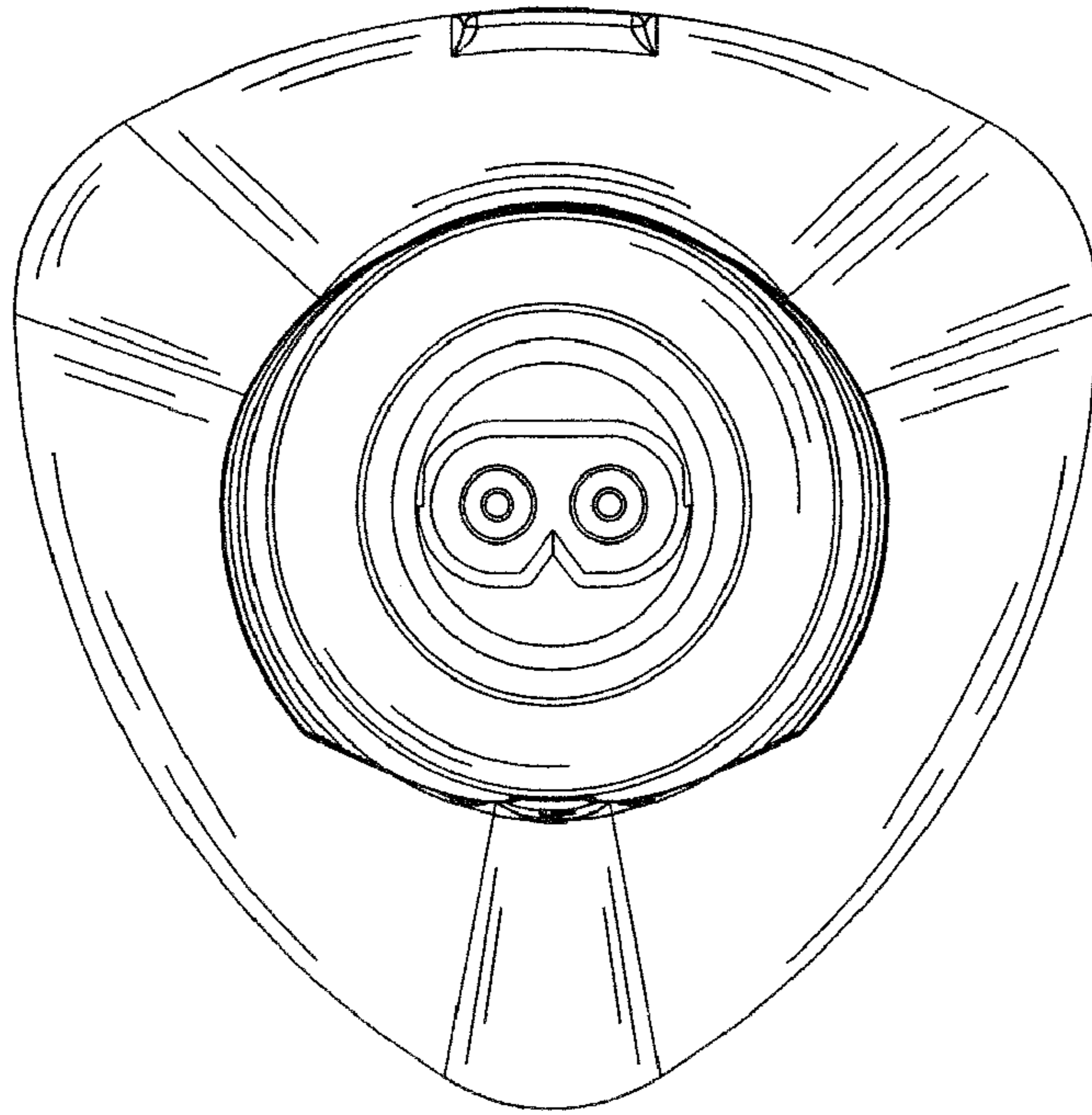

FIG. 5

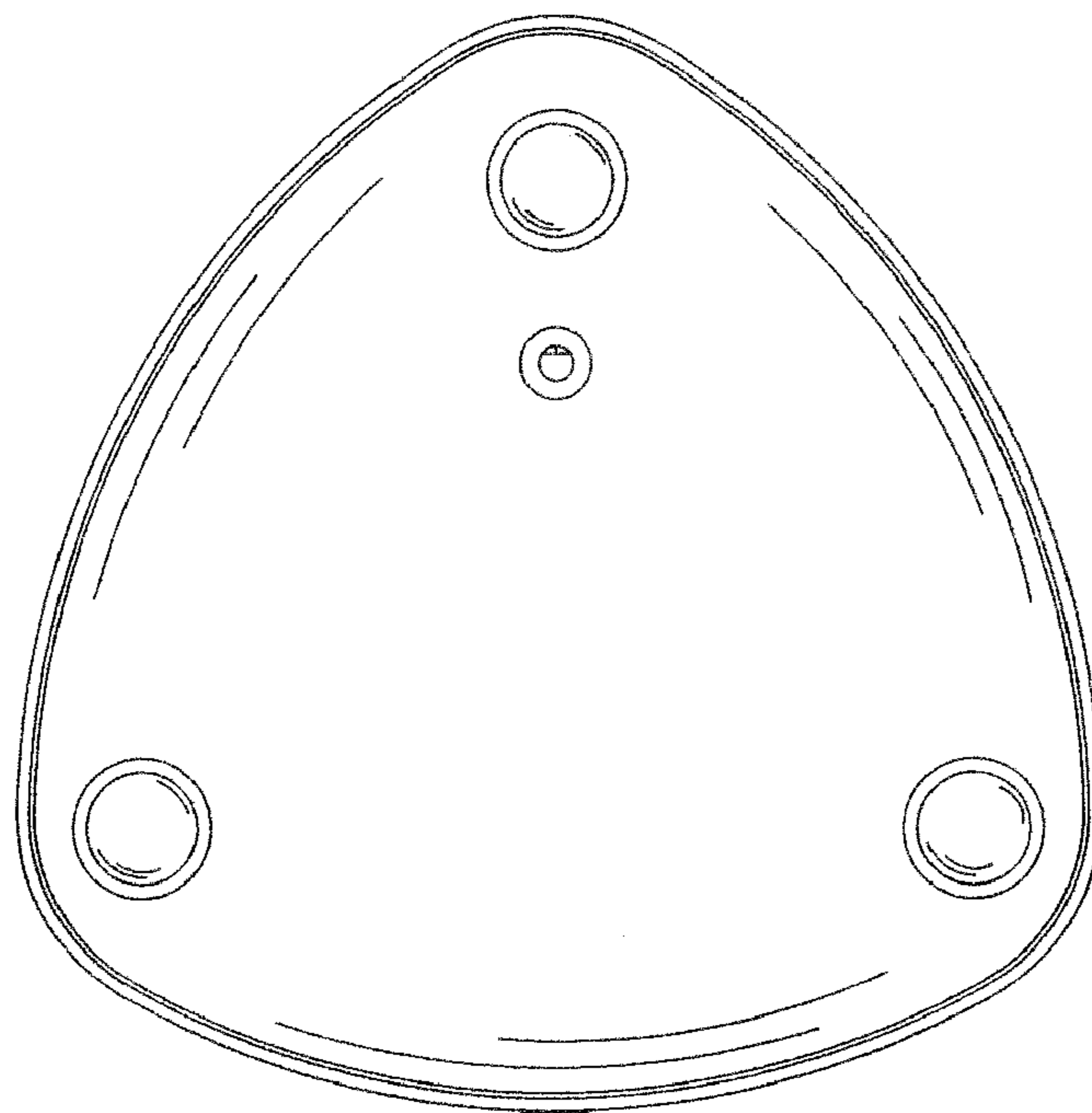

FIG. 6

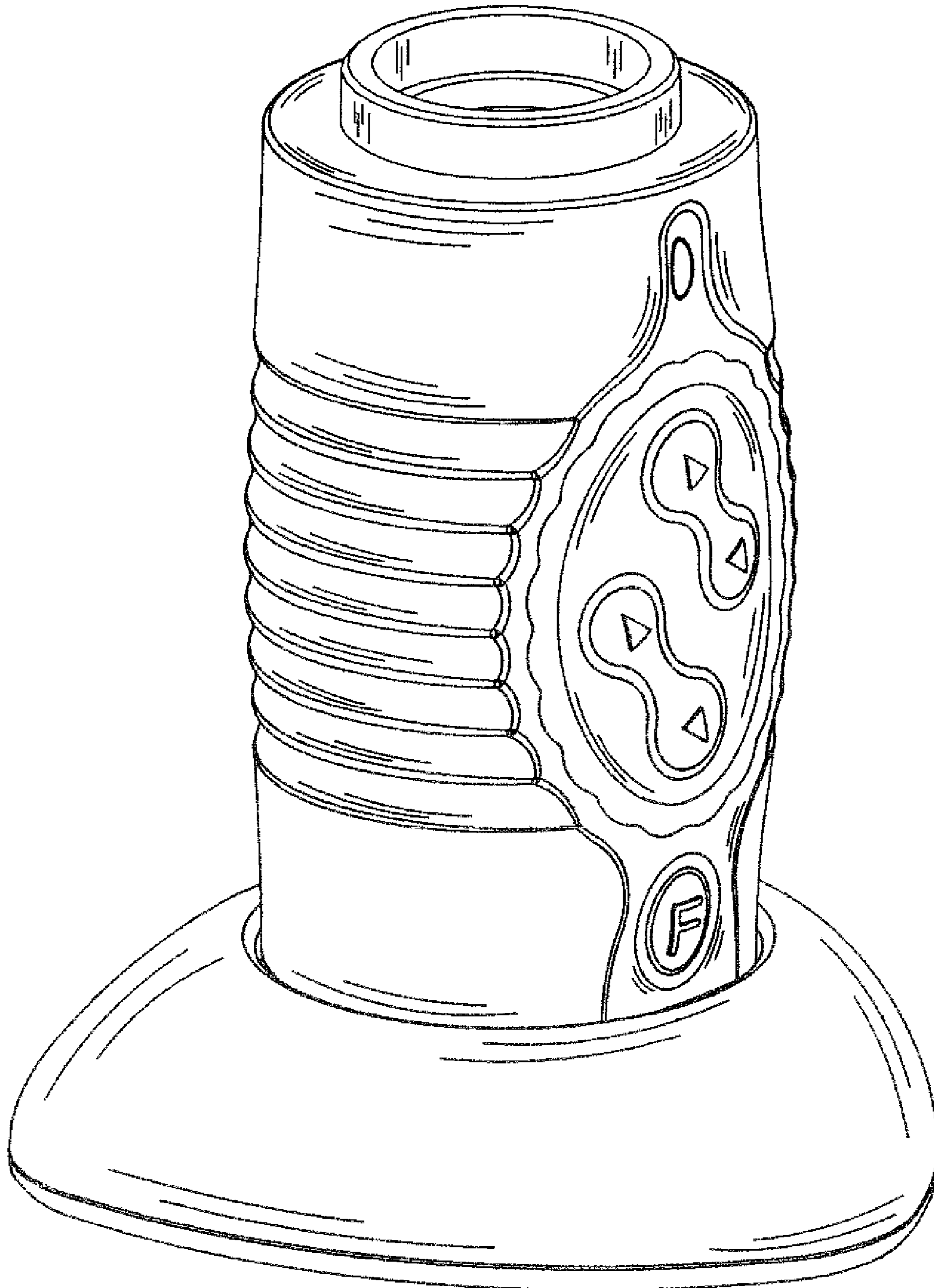

FIG. 7