

US00D546412S

(12) **United States Design Patent**
Kennedy et al.

(10) **Patent No.:** **US D546,412 S**
(45) **Date of Patent:** **** Jul. 10, 2007**

(54) **FILTER CARTRIDGE END**

(75) Inventors: **Gregory Kennedy**, Maplewood, MN (US); **Chaouki Khamis**, Edina, MN (US)

(73) Assignee: **EcoWater Systems LLC**, Woodbury, MN (US)

(**) Term: **14 Years**

(21) Appl. No.: **29/252,810**

(22) Filed: **Jan. 27, 2006**

(51) **LOC (8) Cl.** **23-01**

(52) **U.S. Cl.** **D23/209**

(58) **Field of Classification Search** D23/207,
D23/209; 210/493.2, 234-5, 443-4, 470,
210/238

See application file for complete search history.

(56) **References Cited**

U.S. PATENT DOCUMENTS

- 4,915,831 A * 4/1990 Taylor 210/232
- D433,094 S * 10/2000 Magnusson et al. D23/209
- D472,299 S * 3/2003 Fritze D23/209
- D472,604 S * 4/2003 Fritze D23/209

* cited by examiner

Primary Examiner—Robin Webster

(74) *Attorney, Agent, or Firm*—Patzik, Frank & Samotny, Ltd.

(57) **CLAIM**

The ornamental design for a filter cartridge end, as shown and described.

DESCRIPTION

FIG. 1 is a perspective view of a filter cartridge end showing the new ornamental design, the portions shown in broken lines forming no part of the design sought to be patented;

FIG. 2 is a front view thereof, the front and rear views being a mirror image, and the portions shown in broken lines forming no part of the design sought to be patented;

FIG. 3 is a left side elevational view thereof, the left and right views being a mirror image, and the portions shown in broken lines forming no part of the design sought to be patented;

FIG. 4 is a top plan view thereof, the portions shown in broken lines forming no part of the design sought to be patented;

FIG. 5 is a bottom plan view thereof, the portions shown in broken lines forming no part of the design sought to be patented;

FIG. 6 is a perspective view of a second embodiment of a filter cartridge end showing the new ornamental design, the portions shown in broken lines forming no part of the design sought to be patented;

FIG. 7 is a front view thereof, the front and rear views being a mirror image, and the portions shown in broken lines forming no part of the design sought to be patented;

FIG. 8 is a left side elevational view thereof, the left and right views being a mirror image, and the portions shown in broken lines forming no part of the design sought to be patented;

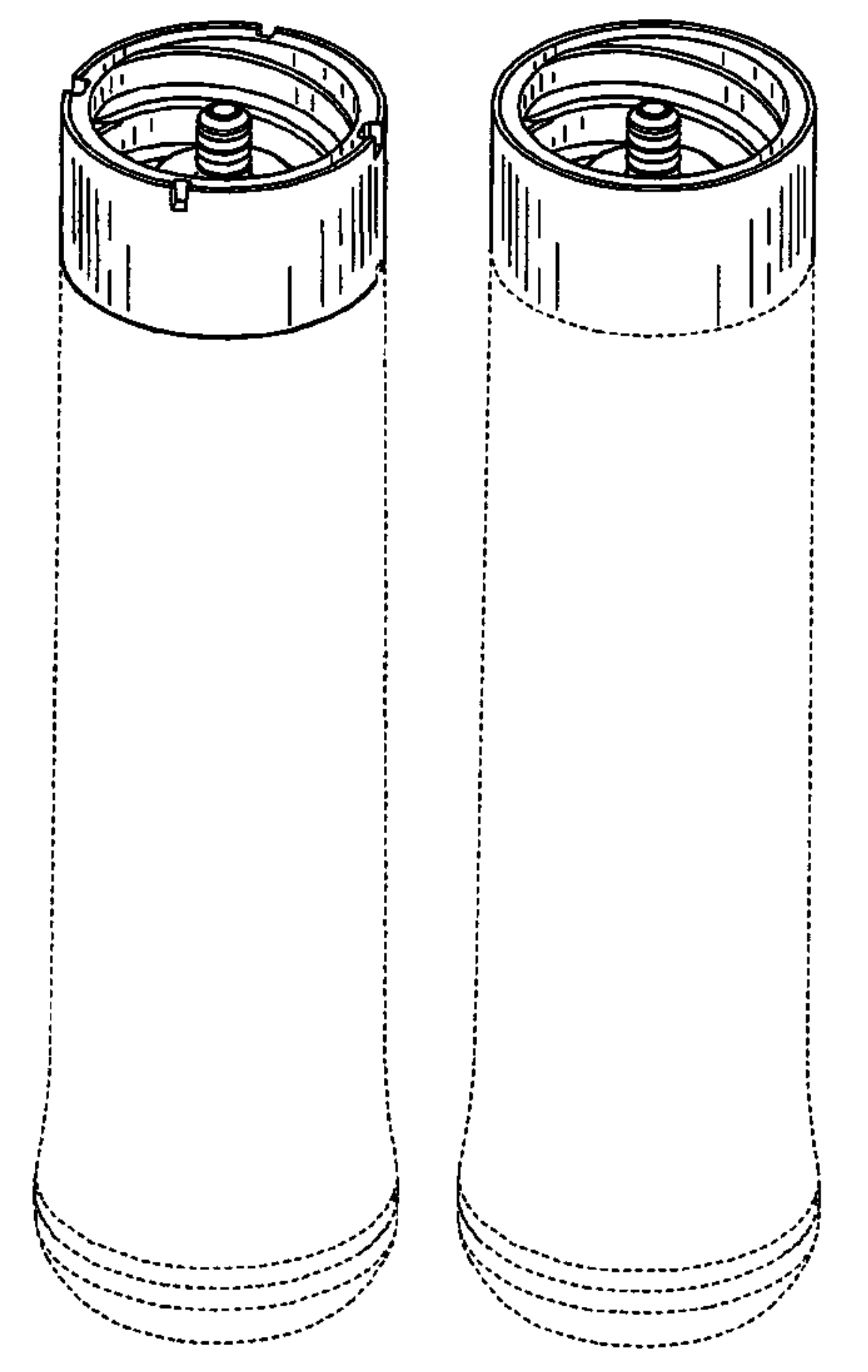

FIG. **9** is a top plan view thereof, the portions shown in broken lines forming no part of the design sought to be patented;

FIG. **10** is a bottom plan view thereof, the portions shown in broken lines forming no part of the design sought to be patented;

FIG. **11** is a perspective view of a third embodiment of a filter cartridge end showing the new ornamental design, the portions shown in broken lines forming no part of the design sought to be patented;

FIG. **12** is a front view thereof, the front and rear views being a mirror image, and the portions shown in broken lines forming no part of the design sought to be patented;

FIG. **13** is a left side elevational view thereof, the left and right views being a mirror image, and the portions shown in broken lines forming no part of the design sought to be patented;

FIG. **14** is a top plan view thereof, the portions shown in broken lines forming no part of the design sought to be patented; and,

FIG. **15** is a bottom plan view thereof, the portions shown in broken lines forming no part of the design sought to be patented.

1 Claim, 9 Drawing Sheets

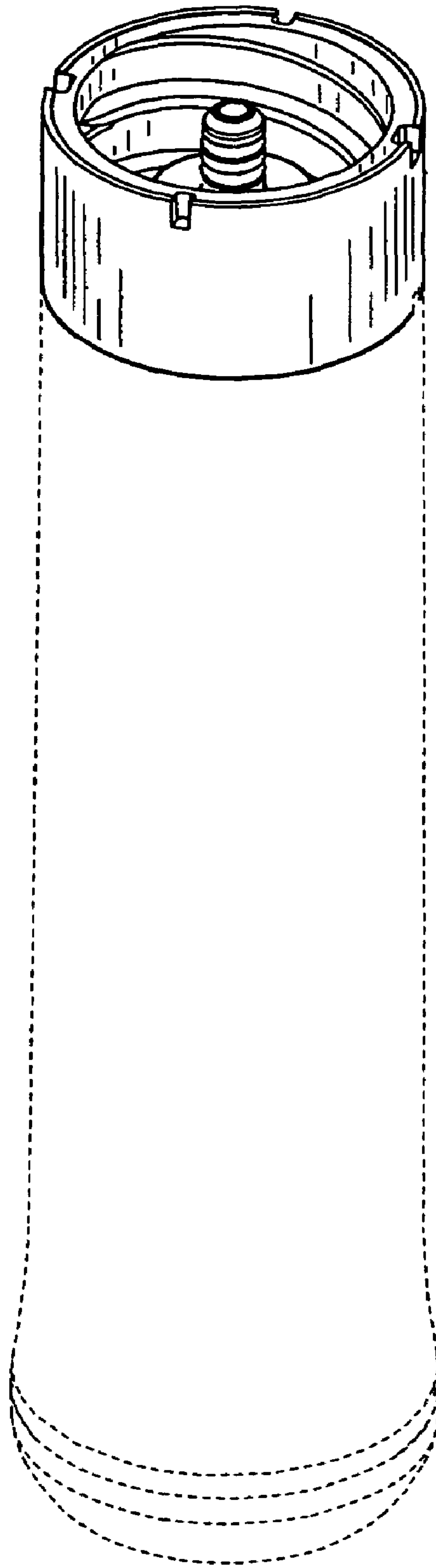

FIG. 1

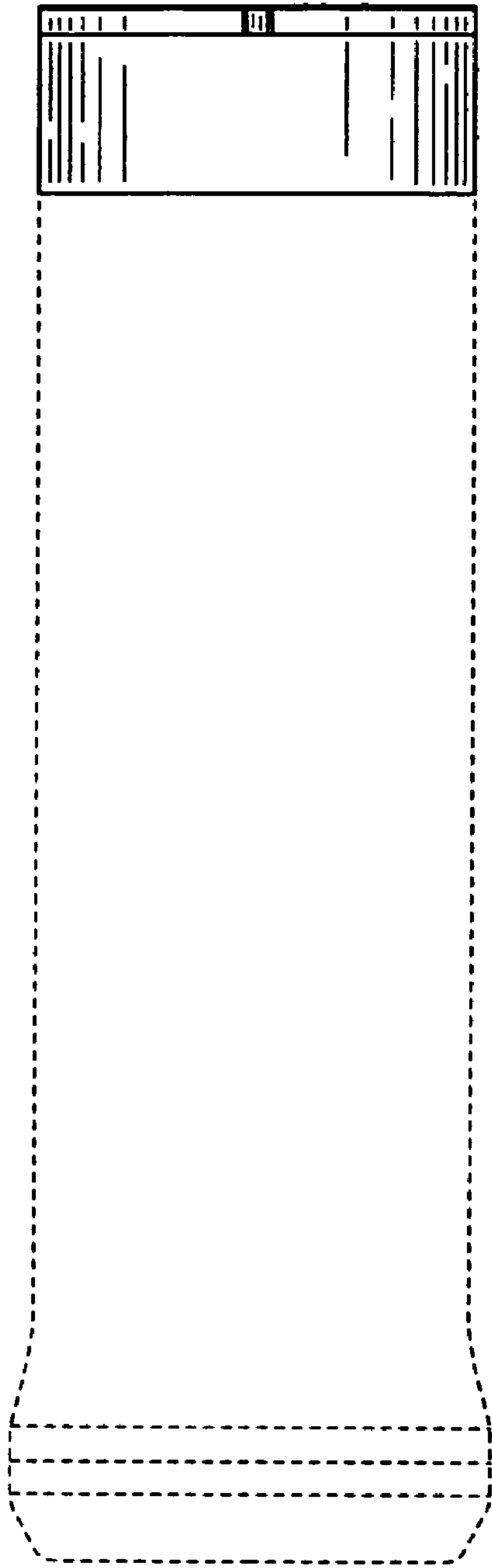

FIG. 2

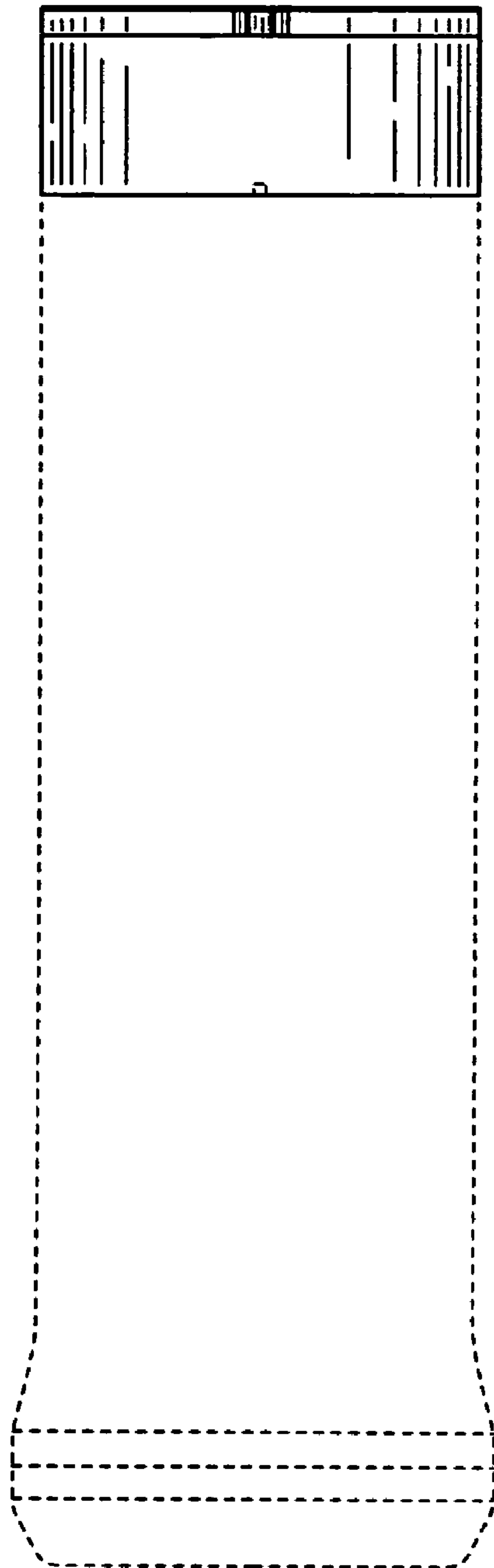

FIG. 3

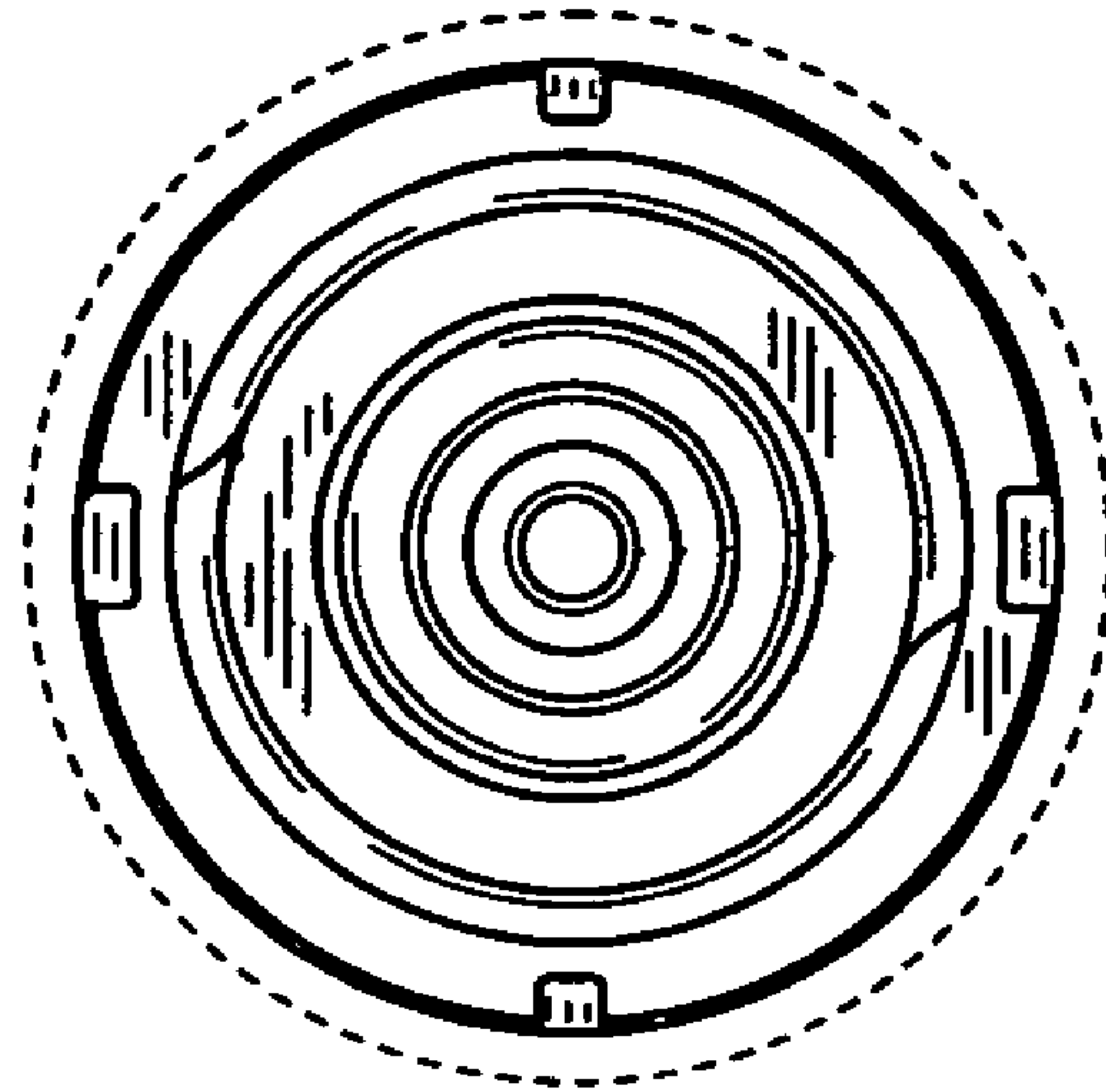

FIG. 4

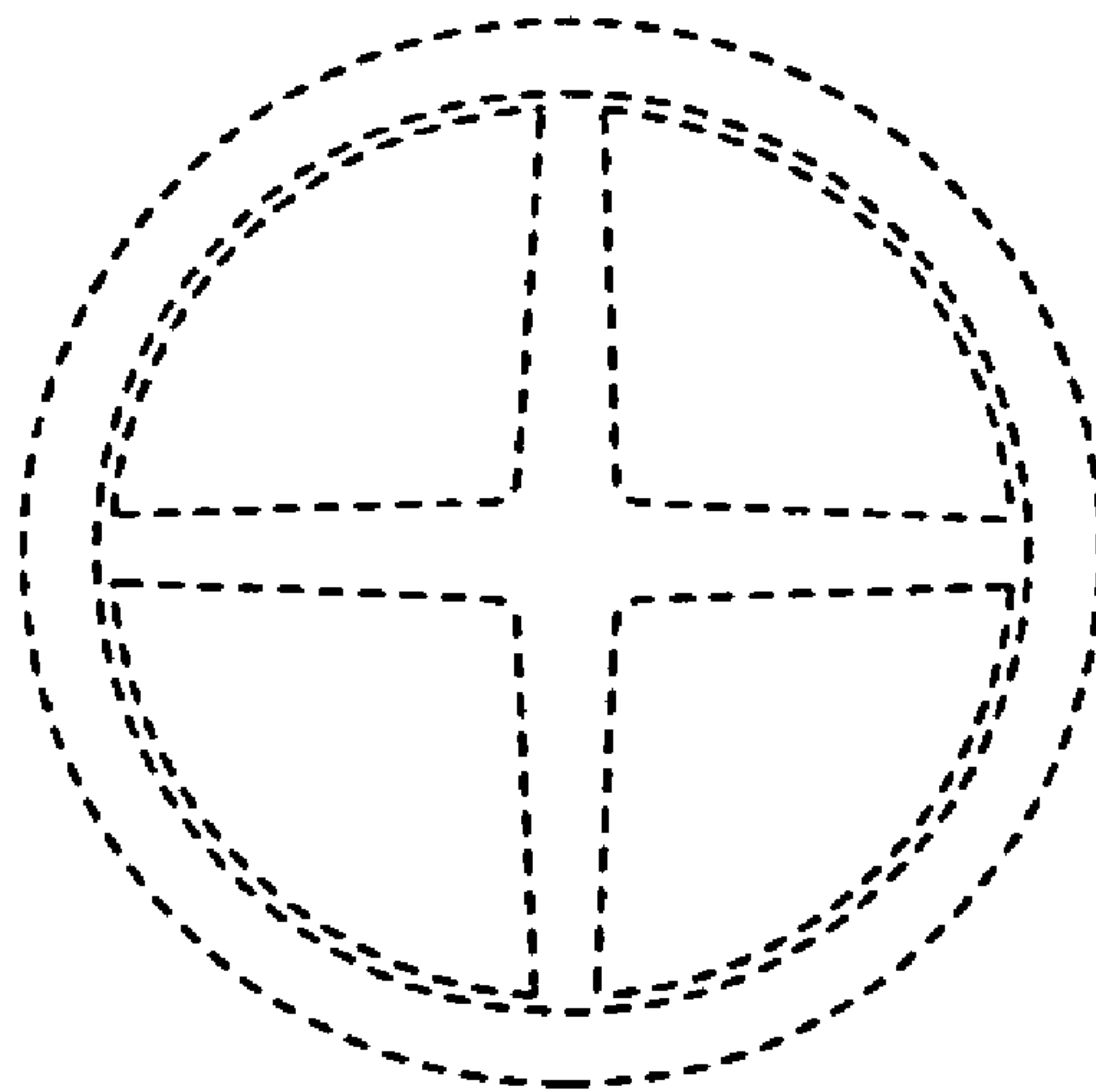

FIG. 5

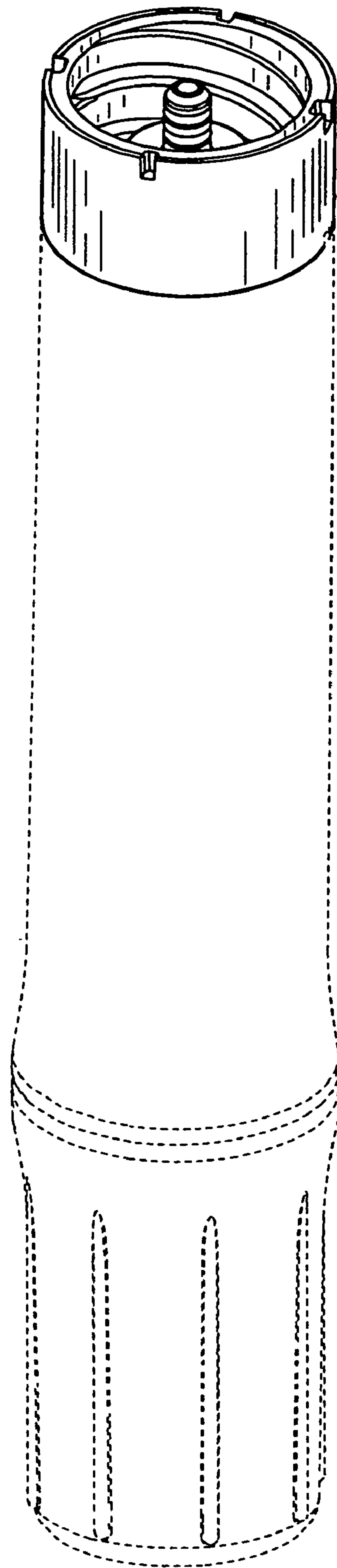

FIG. 6

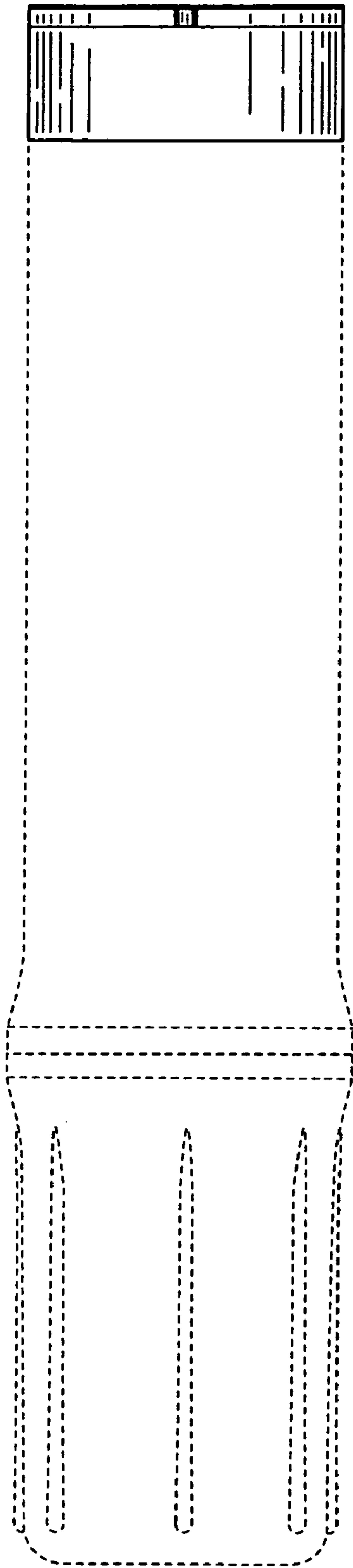

FIG. 7

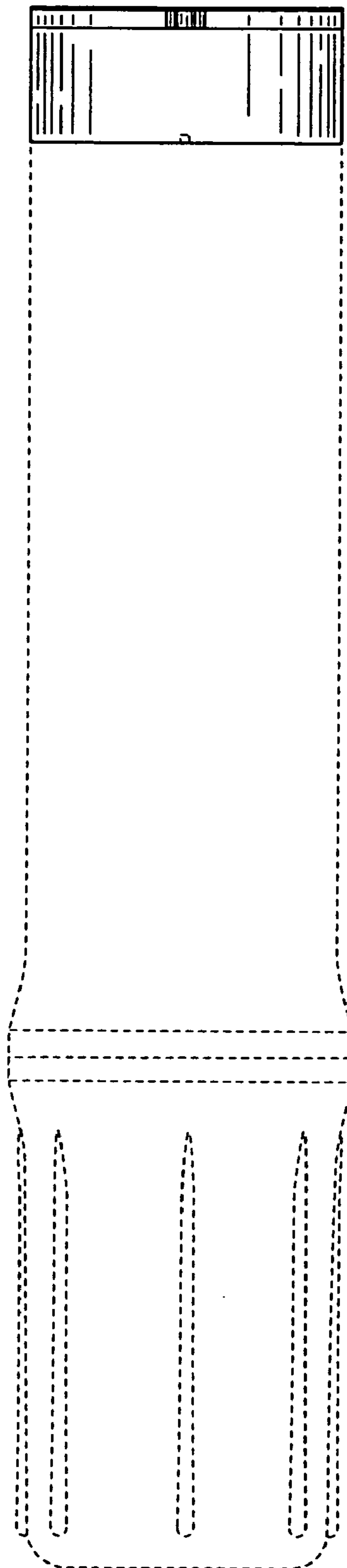

FIG. 8

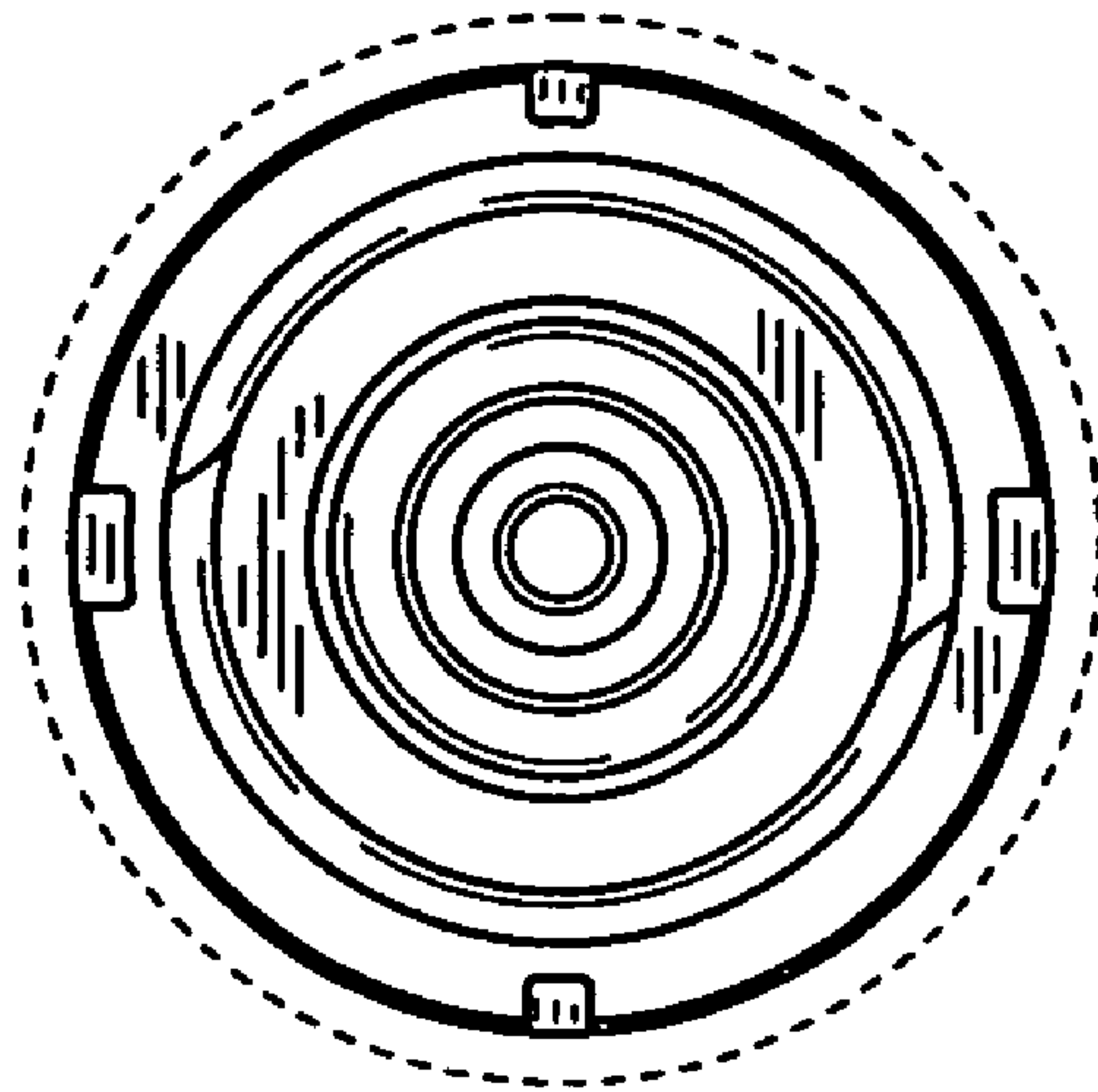

FIG. 9

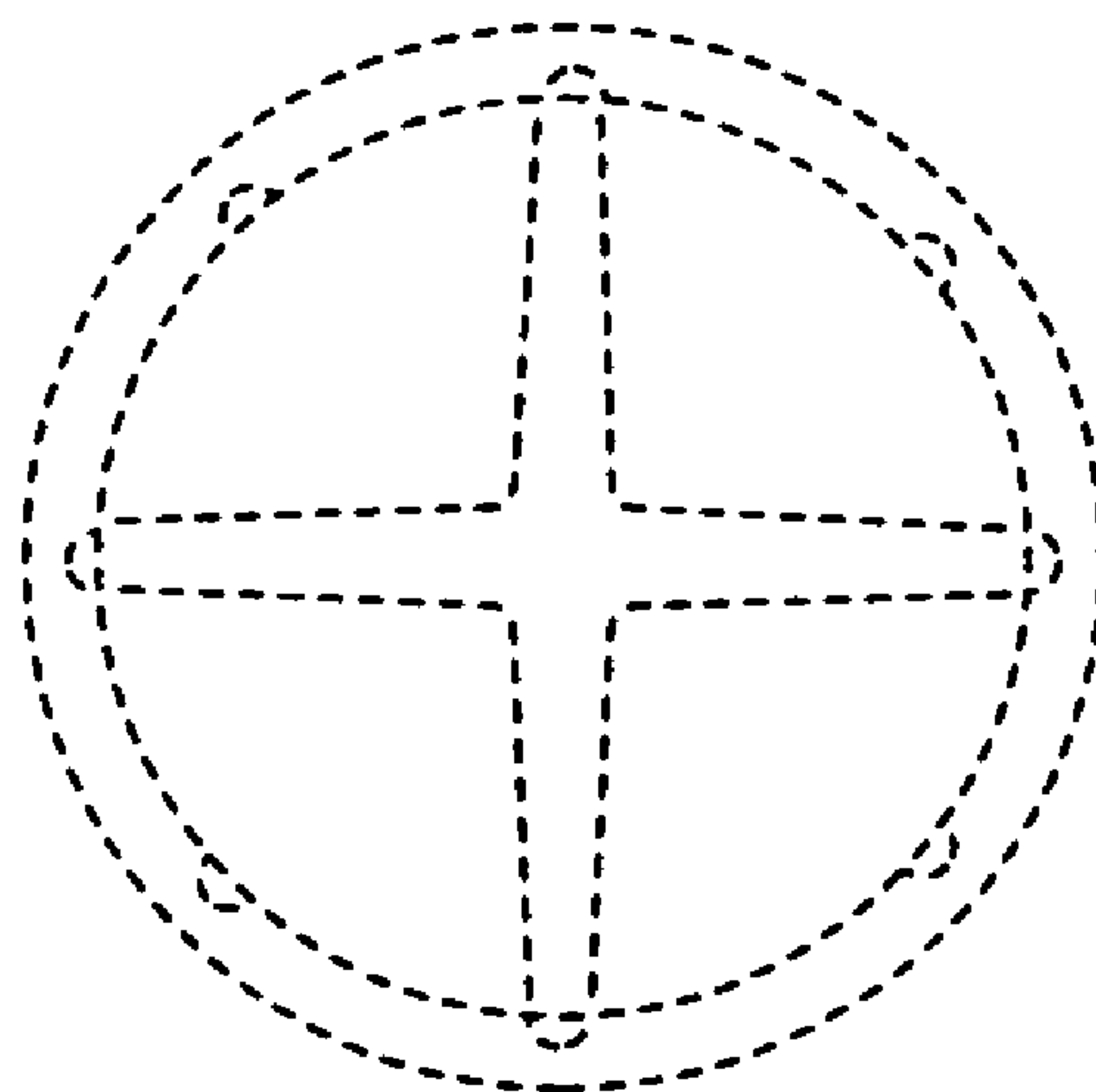

FIG. 10

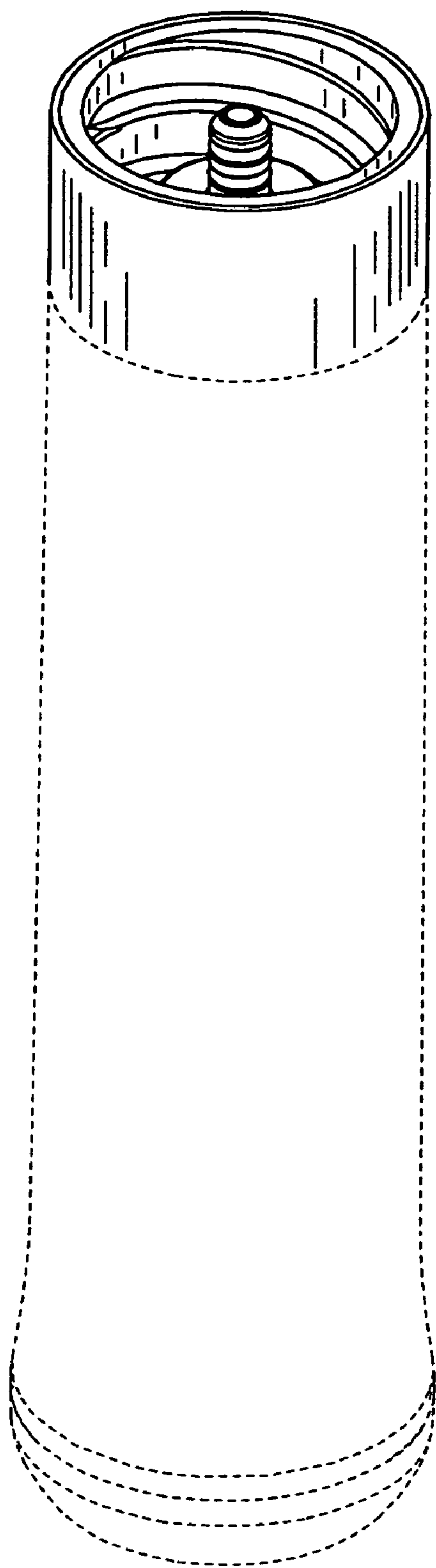

FIG. 11

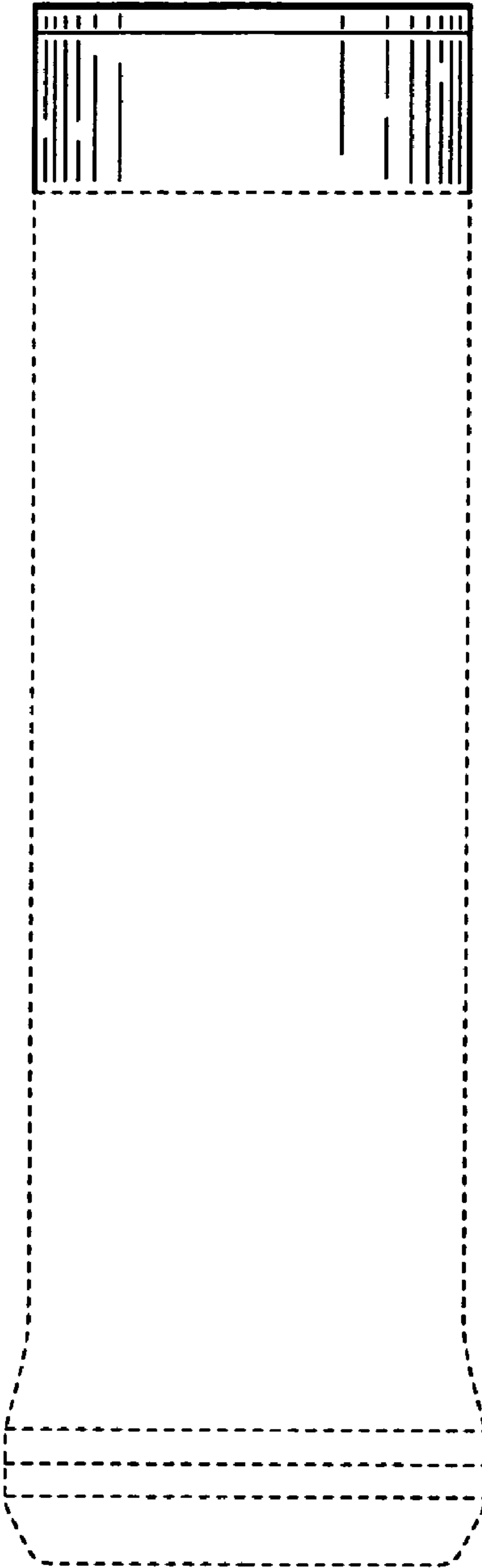

FIG. 12

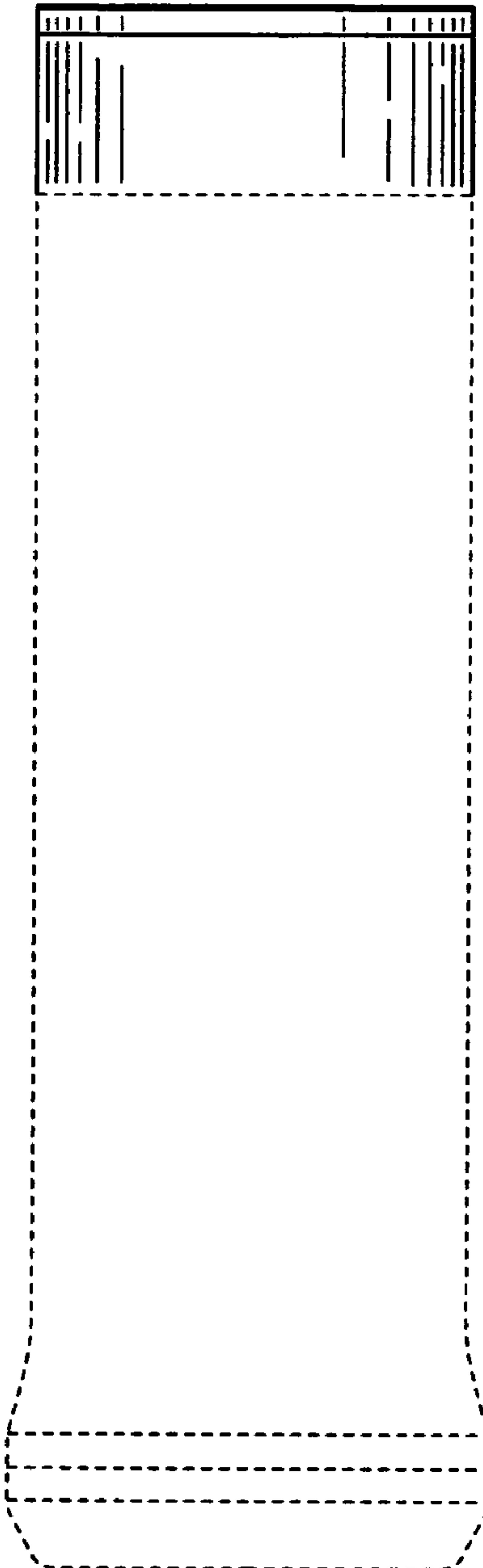

FIG. 13

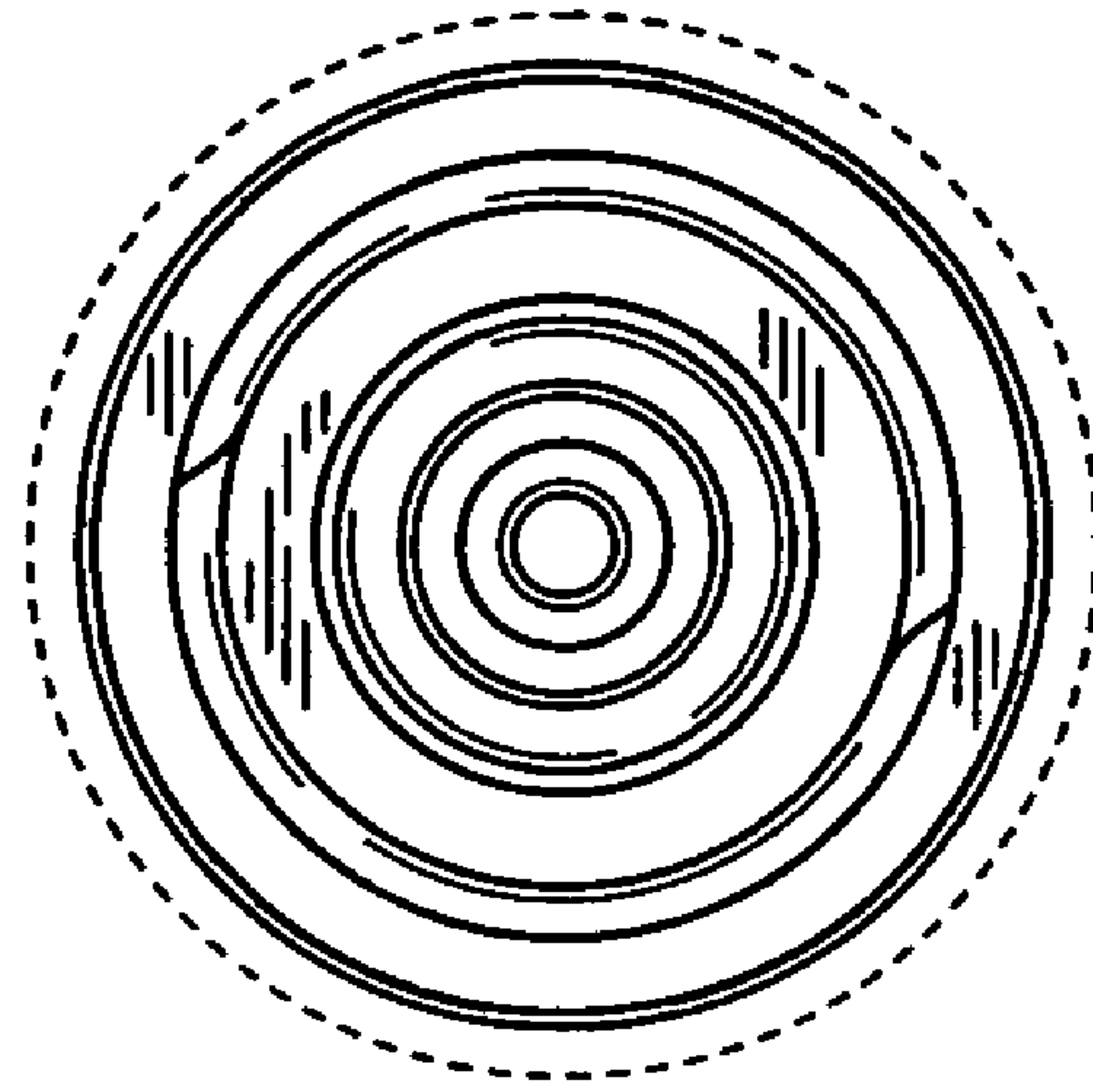

FIG. 14

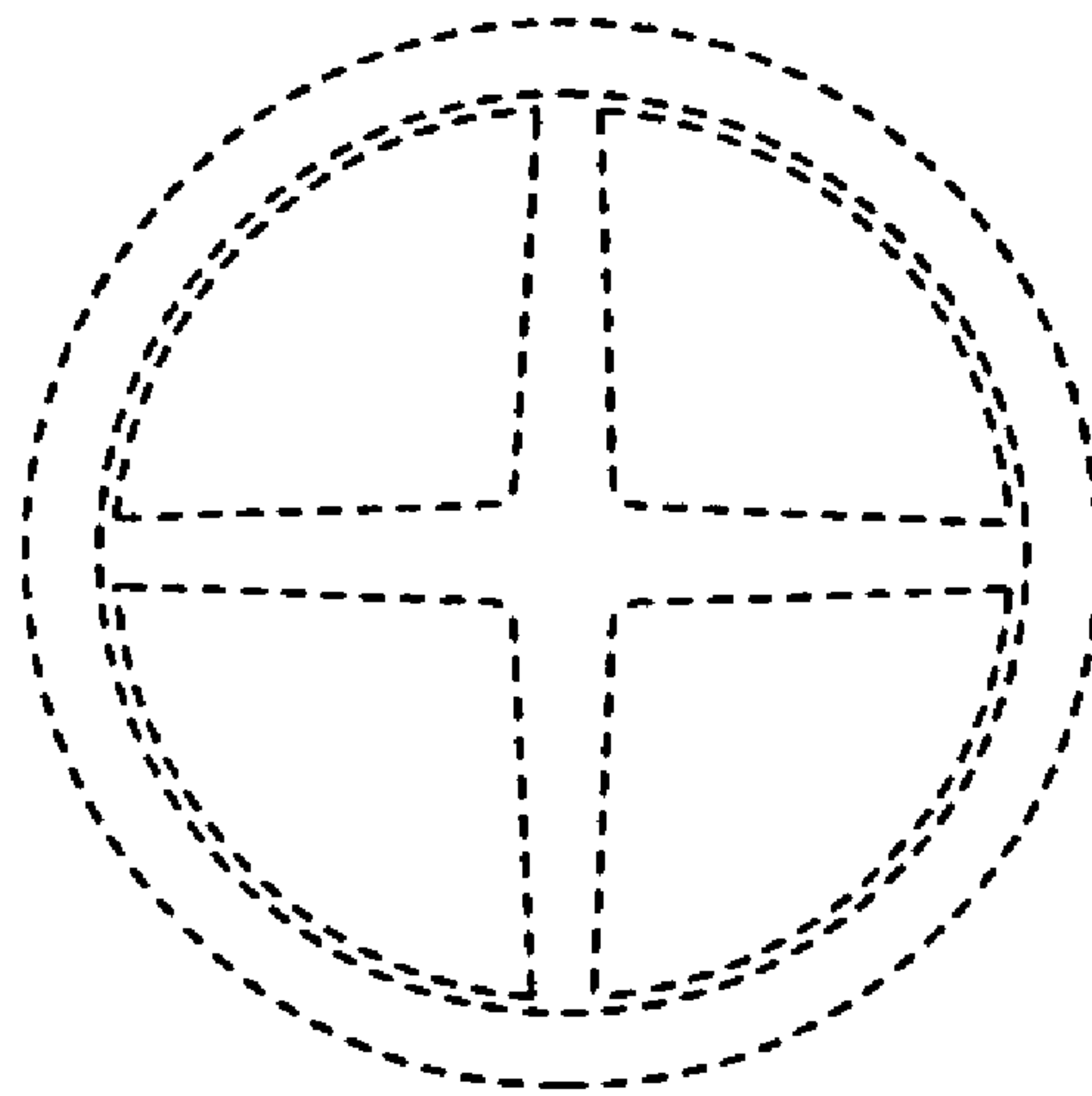

FIG. 15