

US00D546325S

(12) **United States Design Patent**
Chen

(10) **Patent No.:** **US D546,325 S**
(45) **Date of Patent:** **** Jul. 10, 2007**

(54) **MEMORY-CARD TYPE USB MASS STORAGE DEVICE**

(76) Inventor: **I-Ming Chen**, 12F, No. 1, Wanning Street, Wunshan District, Taipei City 116 (TW)

(**) Term: **14 Years**

(21) Appl. No.: **29/235,491**

(22) Filed: **Aug. 3, 2005**

(51) **LOC (8) Cl.** **14-02**

(52) **U.S. Cl.** **D14/356; D14/433; D14/435**

(58) **Field of Classification Search** D14/137, D14/156, 167, 240, 242, 299, 348, 356, 384-5, D14/402, 432-435, 496; 361/685-6, 752, 361/737; 365/63, 131; 439/131, 139-41, 439/144, 152, 518, 528, 638; 710/62, 74; D13/110, 133

See application file for complete search history.

(56) **References Cited**

U.S. PATENT DOCUMENTS

D167,828 S *	9/1952	Florac	D14/194
D330,370 S *	10/1992	Tseng	D14/435
D408,384 S *	4/1999	Hata et al.	D14/433
5,933,328 A *	8/1999	Wallace et al.	361/737
D425,487 S *	5/2000	Lee	D13/154
6,089,908 A *	7/2000	Huang	439/528
6,435,409 B1 *	8/2002	Hu	235/441
D479,712 S *	9/2003	Ng	D14/156

D484,482 S *	12/2003	Tanio	D14/167
D486,483 S *	2/2004	Bloomberg et al.	D14/248
D494,175 S *	8/2004	Kawasaki	D14/384
2002/0177362 A1 *	11/2002	Chang	439/638
2004/0063346 A1 *	4/2004	Lin et al.	439/131

FOREIGN PATENT DOCUMENTS

DE EU000355607-001 * 6/2005

* cited by examiner

Primary Examiner—Robin Webster

Assistant Examiner—Karen E. Patterson

(74) *Attorney, Agent, or Firm*—Rosenberg, Klein & Lee

(57) **CLAIM**

The ornamental design for a “memory-card type USB mass storage device,” as shown and described.

DESCRIPTION

FIG. 1 is a perspective view of an memory-card type USB mass storage device showing my design;

FIG. 2 is a front view thereof;

FIG. 3 is a back view thereof;

FIG. 4 is a left side view thereof;

FIG. 5 is a right side view thereof;

FIG. 6 is a top plan view thereof;

FIG. 7 is a bottom view thereof; and,

FIG. 8 is an exploded view in an alternate position.

1 Claim, 5 Drawing Sheets

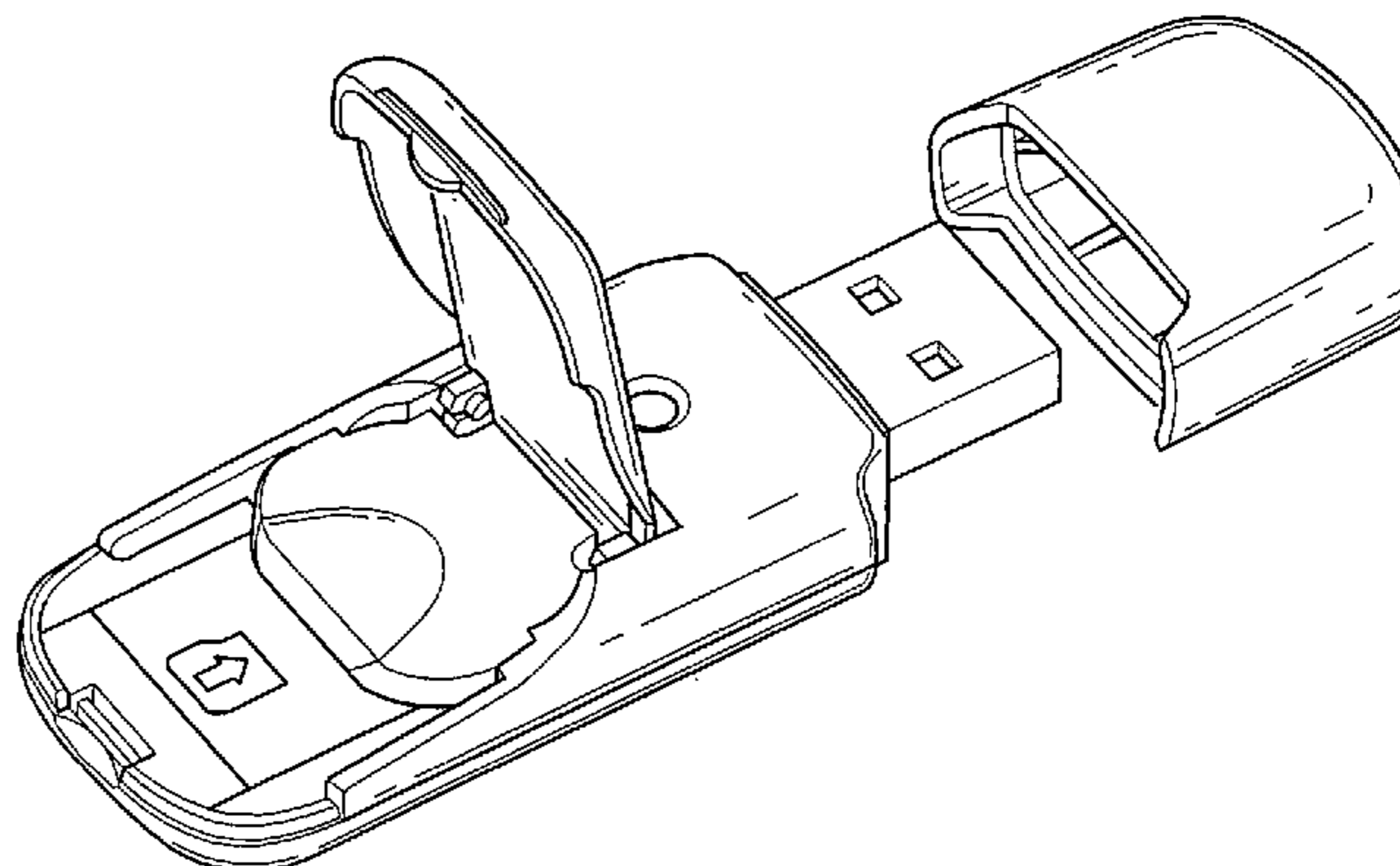
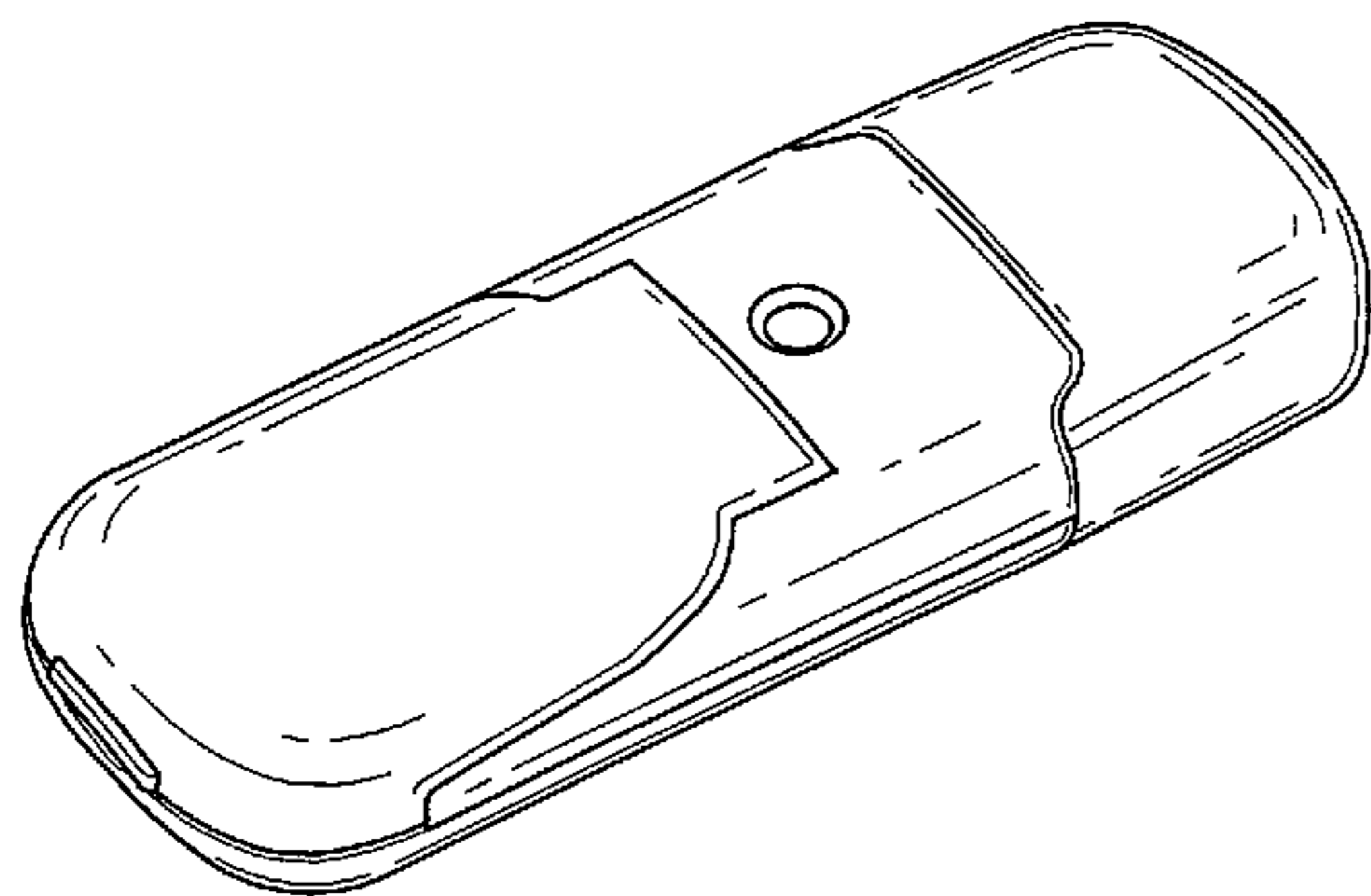

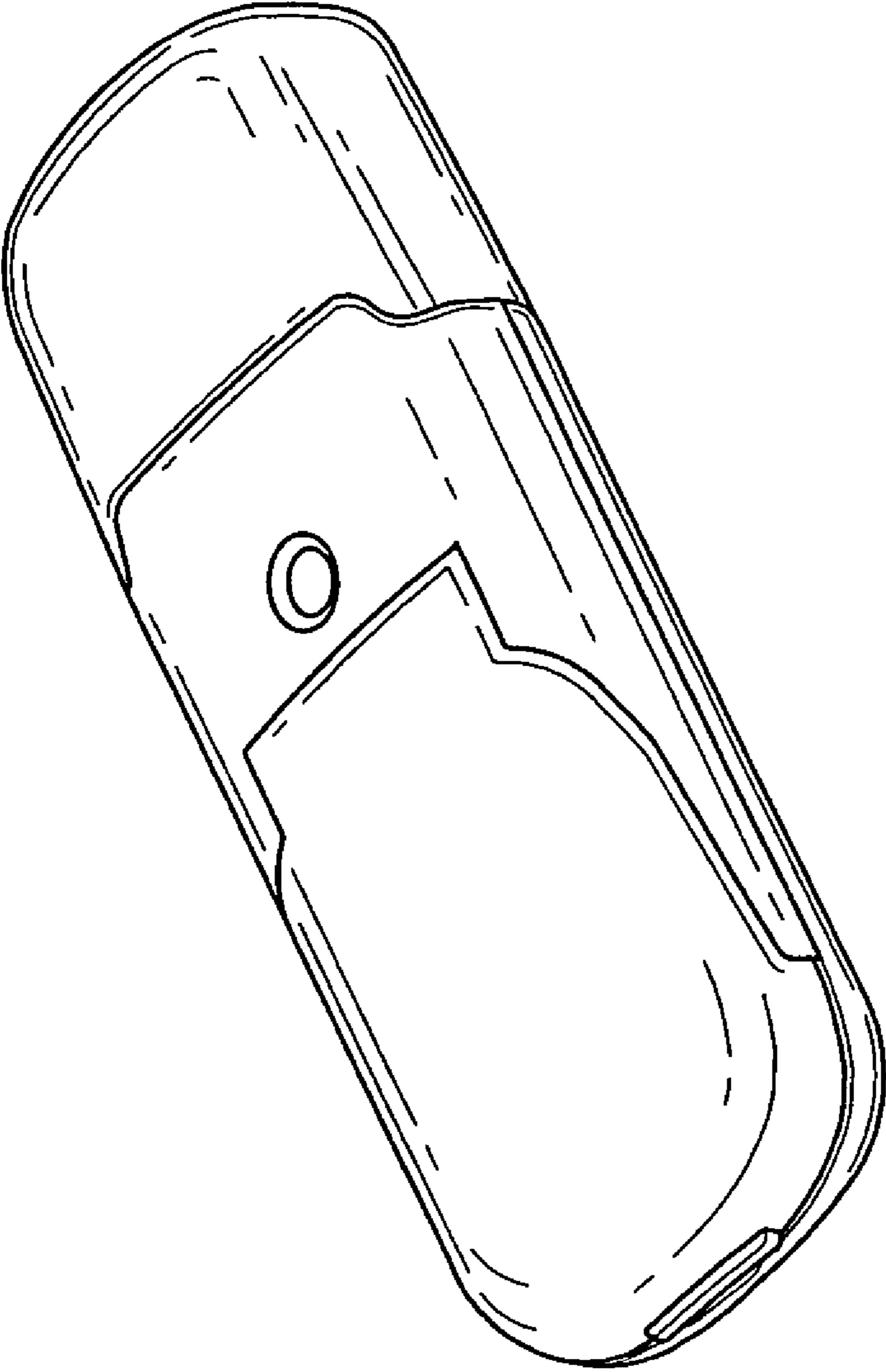

FIG. 1

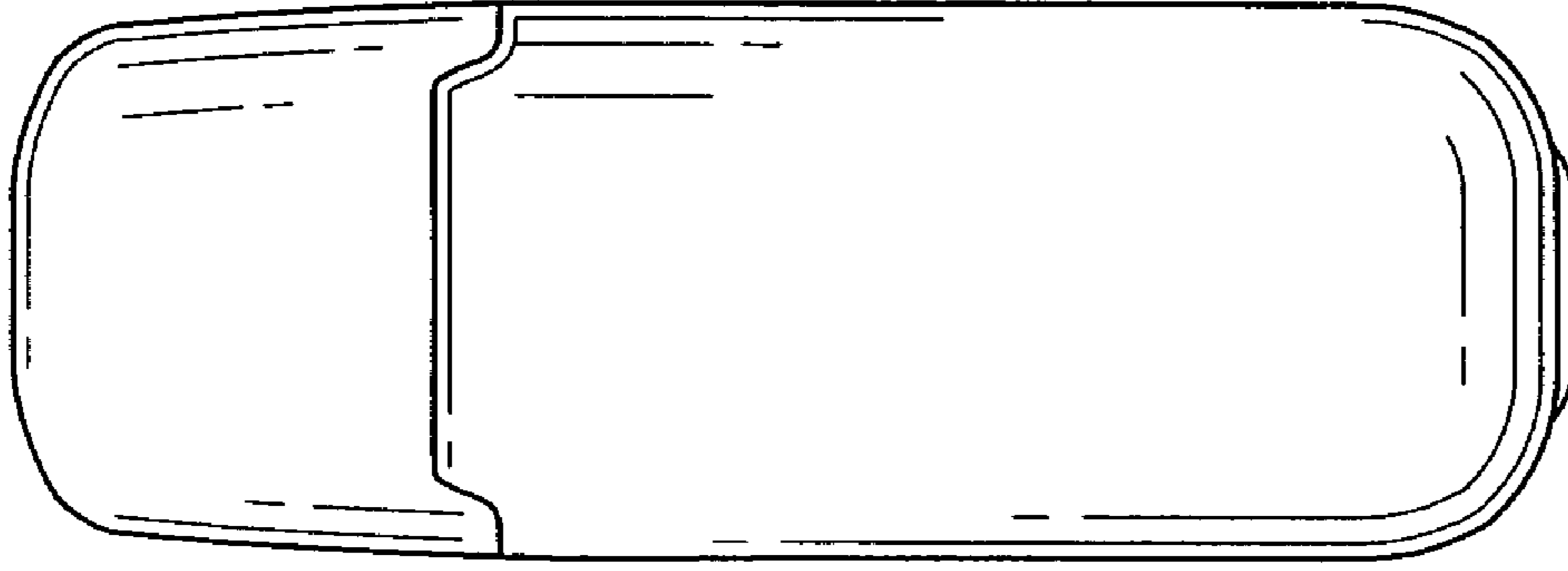

FIG. 3

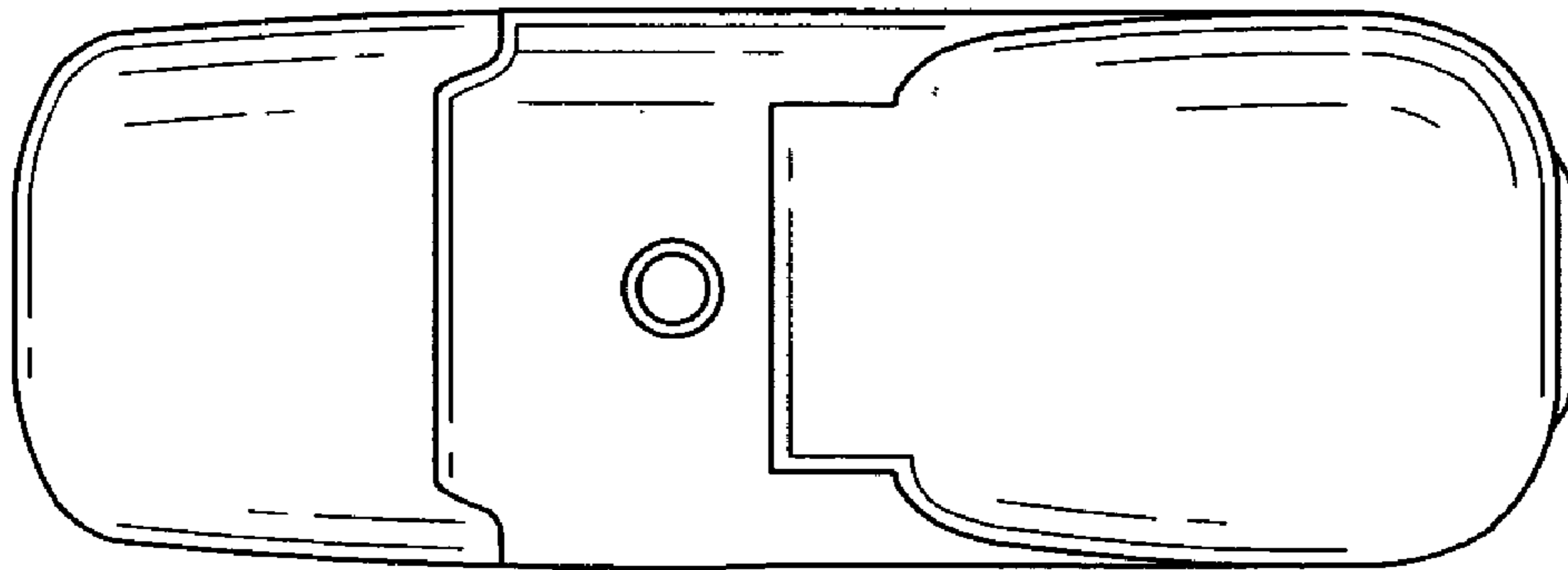

FIG. 2

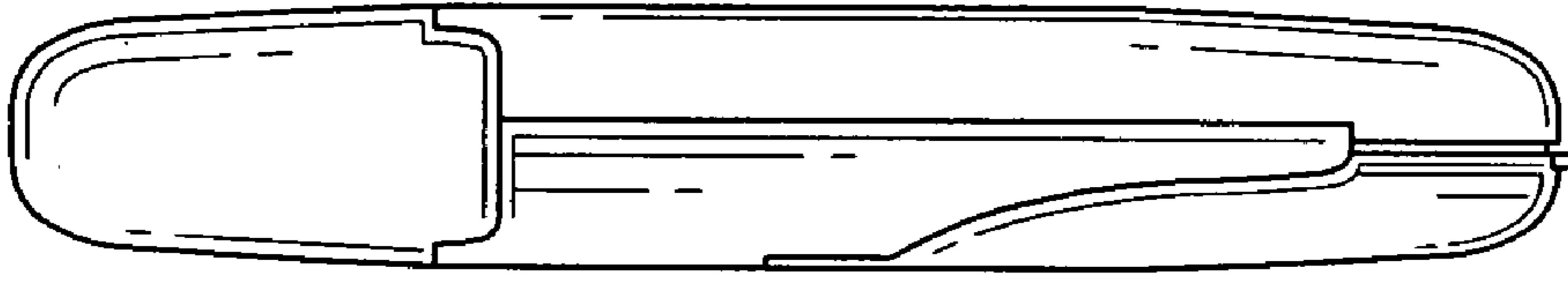

FIG. 5

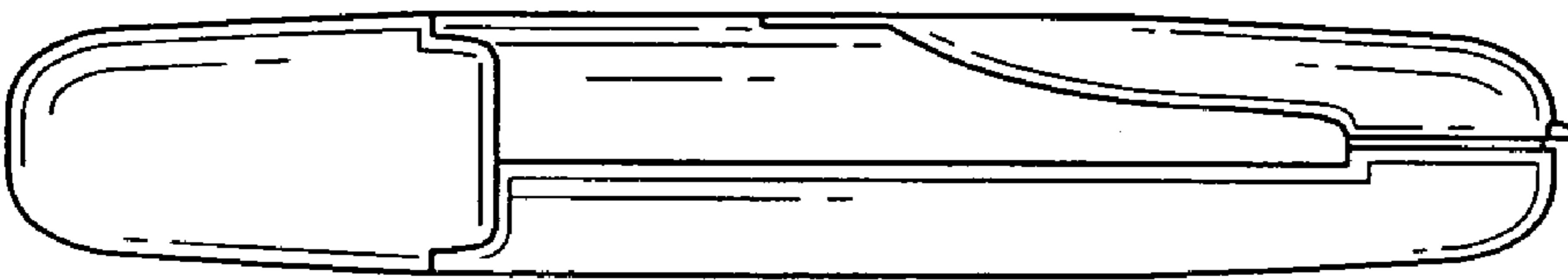

FIG. 4

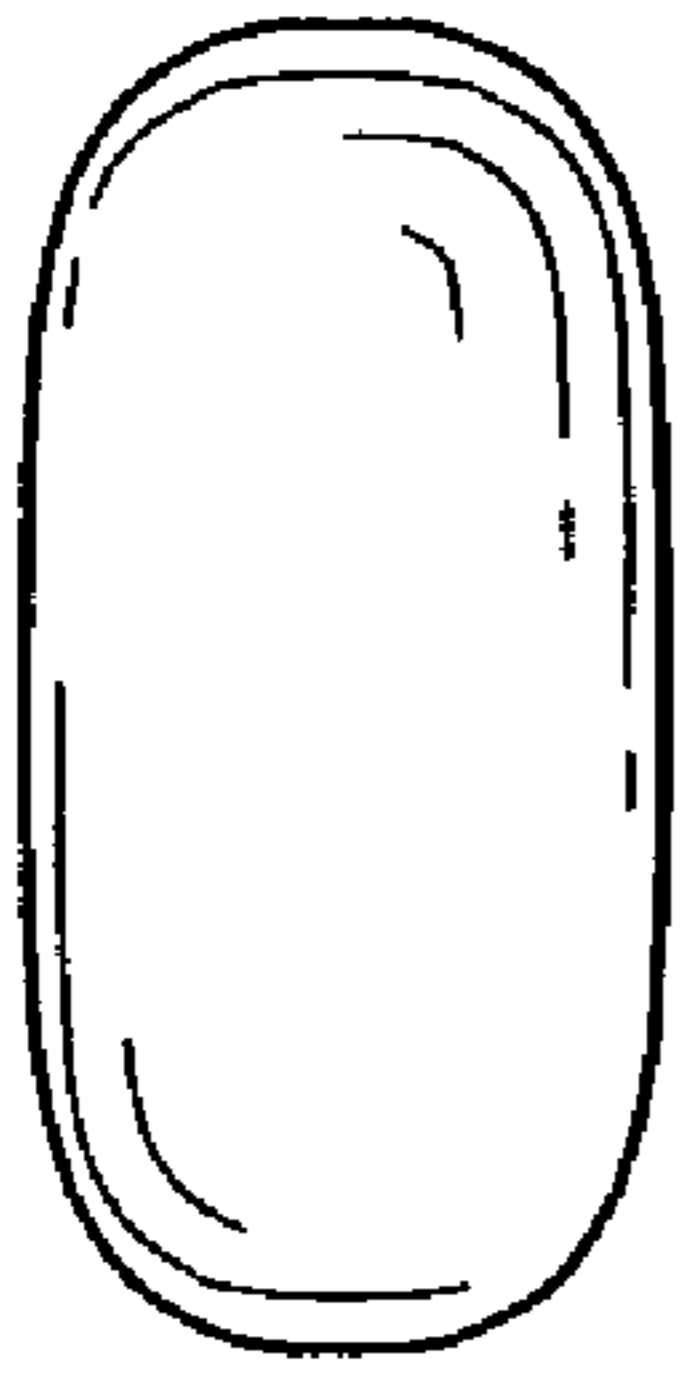

FIG. 6

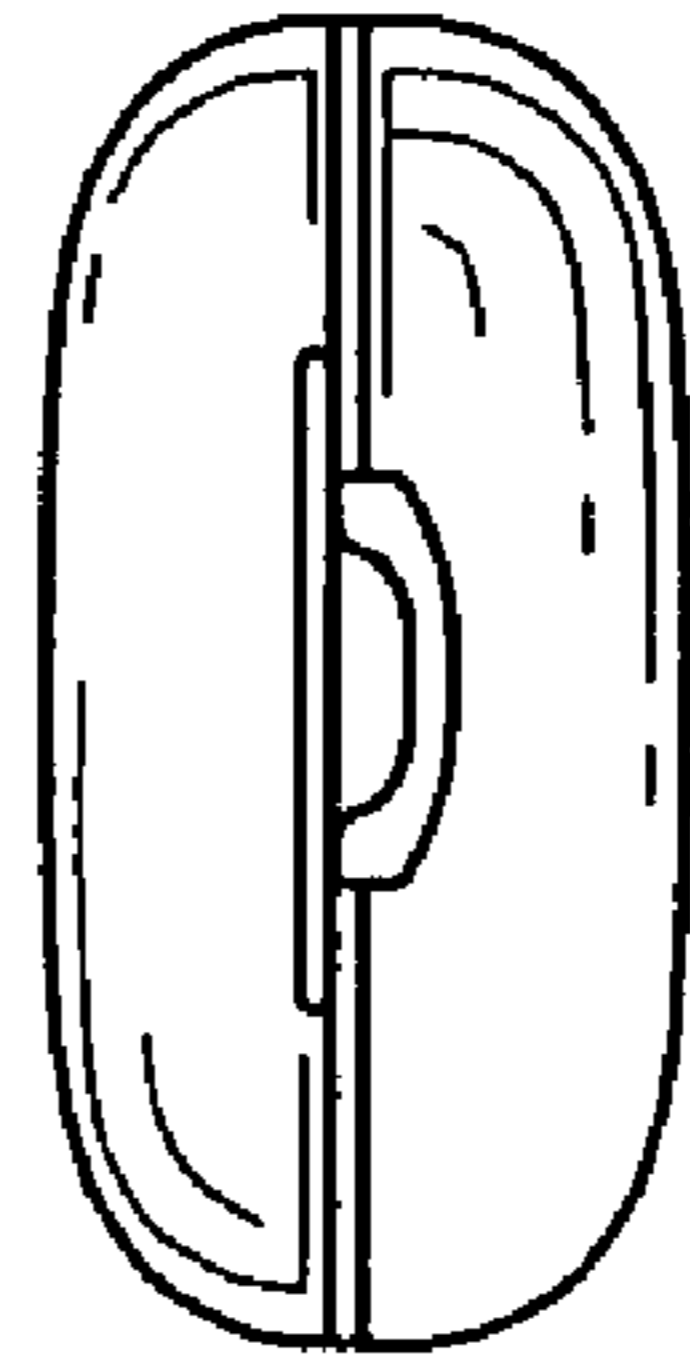

FIG. 7

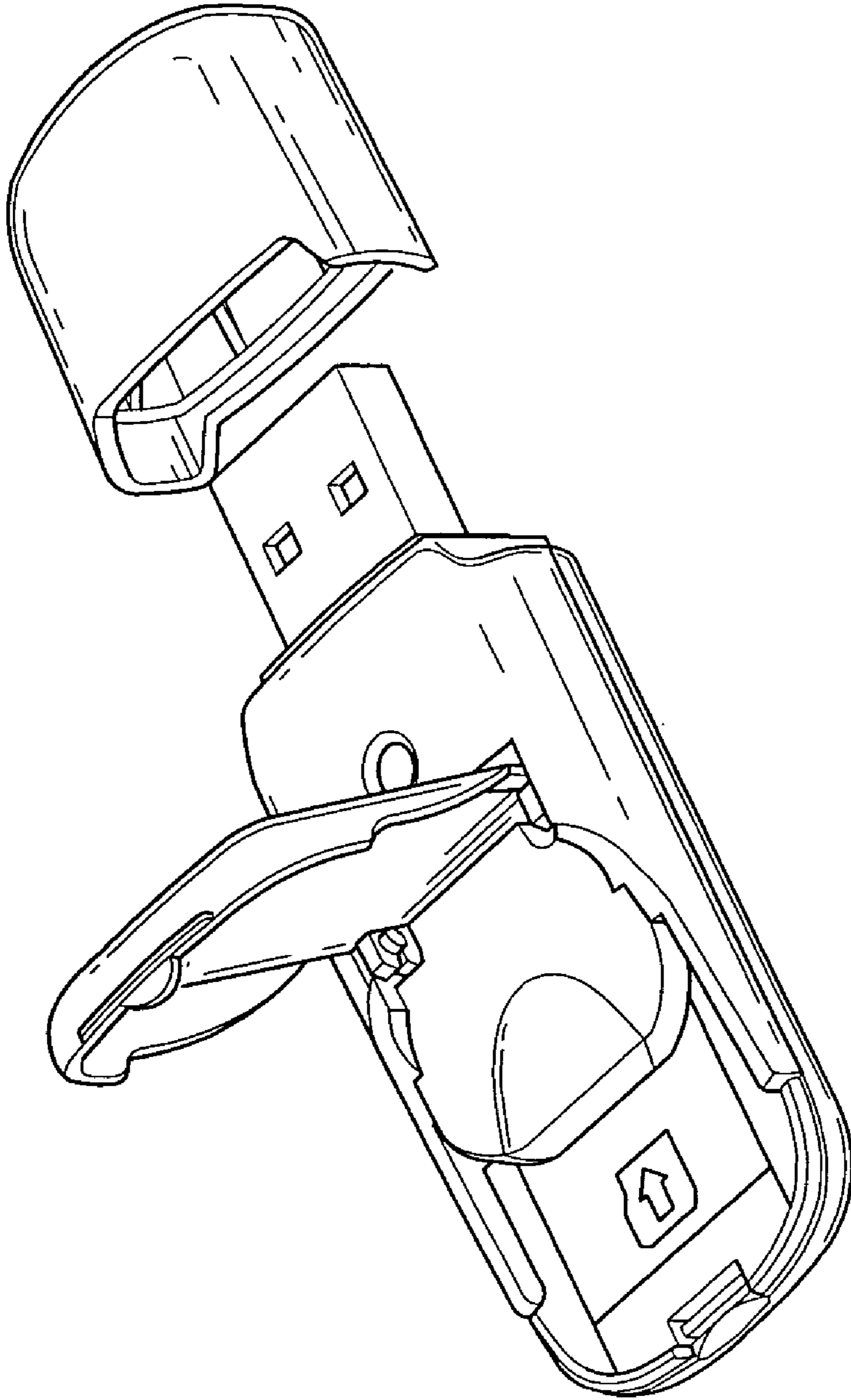

FIG. 8