

US00D546314S

(12) **United States Design Patent** (10) **Patent No.:** **US D546,314 S**
Im (45) **Date of Patent:** **** Jul. 10, 2007**

(54) **CELLULAR PHONE**

(75) Inventor: **Jae Boem Im**, Seoul (KR)

(73) Assignee: **LG Electronics Inc.**, Seoul (KR)

(**) Term: **14 Years**

(21) Appl. No.: **29/259,110**

(22) Filed: **May 3, 2006**

(30) **Foreign Application Priority Data**

Nov. 29, 2005 (KR) 30-2005-0040253

(51) **LOC (8) Cl.** **14-03**

(52) **U.S. Cl.** **D14/138**

(58) **Field of Classification Search** D14/137,
D14/138, 147, 218, 341-347; 455/90.3,
455/556.1, 556.2, 575.1, 575.3, 575.4; 379/433.01-433.13;
361/814; 348/14.02

See application file for complete search history.

(56) **References Cited**

U.S. PATENT DOCUMENTS

D485,819 S *	1/2004	Ahlgren	D14/138
D488,789 S *	4/2004	Lee	D14/138
D492,657 S *	7/2004	Jensfelt	D14/138
D496,921 S *	10/2004	Hwang	D14/138
D500,992 S *	1/2005	Shen et al.	D14/138
D505,932 S *	6/2005	Eckholm et al.	D14/138
D513,741 S *	1/2006	Jensfelt	D14/138
D514,538 S *	2/2006	Chan et al.	D14/138
D515,528 S *	2/2006	Miyazawa et al.	D14/138
D515,532 S *	2/2006	Shintani	D14/138
D515,533 S *	2/2006	Yano	D14/138
D515,541 S *	2/2006	Jensfelt	D14/138
D515,543 S *	2/2006	Shintani	D14/138
D517,039 S *	3/2006	Lee	D14/138
D523,836 S *	6/2006	Park	D14/138
D523,837 S *	6/2006	Lee	D14/138
D525,229 S *	7/2006	Friesen et al.	D14/138
D530,696 S *	10/2006	Lee	D14/138
D531,976 S *	11/2006	Kim et al.	D14/138
D532,767 S *	11/2006	Yoshino et al.	D14/138

2005/0186987 A1 *	8/2005	Liu	455/556.1
2006/0188091 A1 *	8/2006	Chen	379/433.01
2006/0234785 A1 *	10/2006	Lee et al.	455/575.1

FOREIGN PATENT DOCUMENTS

WO DM/068067 * 8/2006

OTHER PUBLICATIONS

LG B2250, announced 3rd quarter 2005, [online], [retrieved on Dec. 18, 2006]. Retrieved from Internet ,<URL: http://www.gsmarena.com>.*

BenQ-Siemens S81, announced Feb. 2006, [online], [retrieved on Dec. 18, 2006]. Retrieved from Internet ,<URL: http://www.gsmarena.com>.*

Sony Ericsson V630, announced May 2006, [online], [retrieved on Dec. 18, 2006]. Retrieved from Internet ,<URL: http://www.gsmarena.com>.*

Nokia N72, announced Apr. 2006, [online], [retrieved on Dec. 18, 2006]. Retrieved from Internet ,<URL: http://www.gsmarena.com>.*

* cited by examiner

Primary Examiner—Jeffrey Asch

Assistant Examiner—Bridget L. Eland

(74) *Attorney, Agent, or Firm*—Birch, Stewart, Kolasch & Birch, LLP

(57) **CLAIM**

I claim the ornamental design for cellular phone, as shown and described.

DESCRIPTION

FIG. 1 is a perspective view of cellular phone showing the new design:

FIG. 2 is a front elevation view thereof;

FIG. 3 is a rear elevation view thereof;

FIG. 4 is a left-side elevation view thereof;

FIG. 5 is a right-side elevation view thereof;

FIG. 6 is a top plan view thereof; and,

FIG. 7 is a bottom plan view thereof.

1 Claim, 4 Drawing Sheets

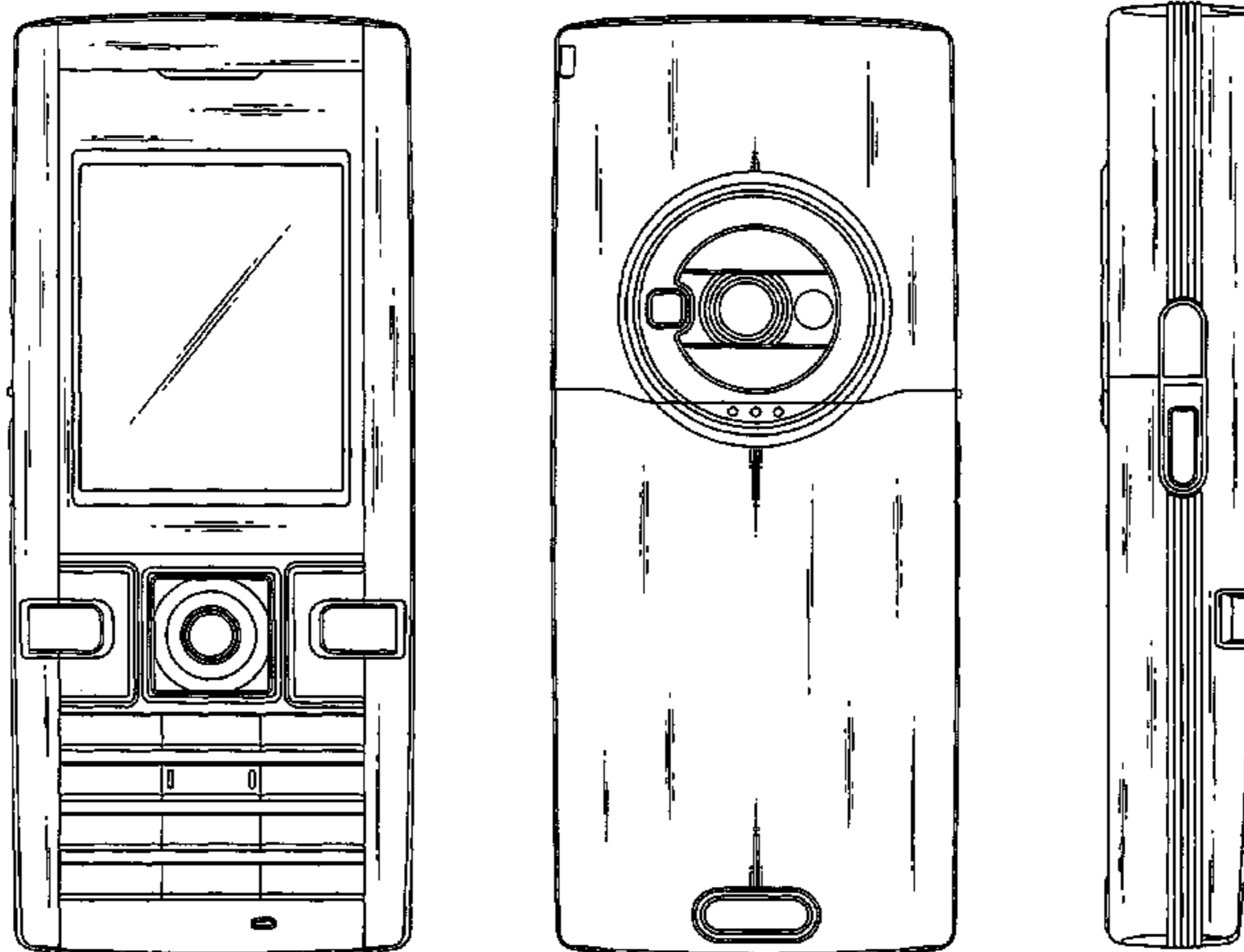

FIG. 1

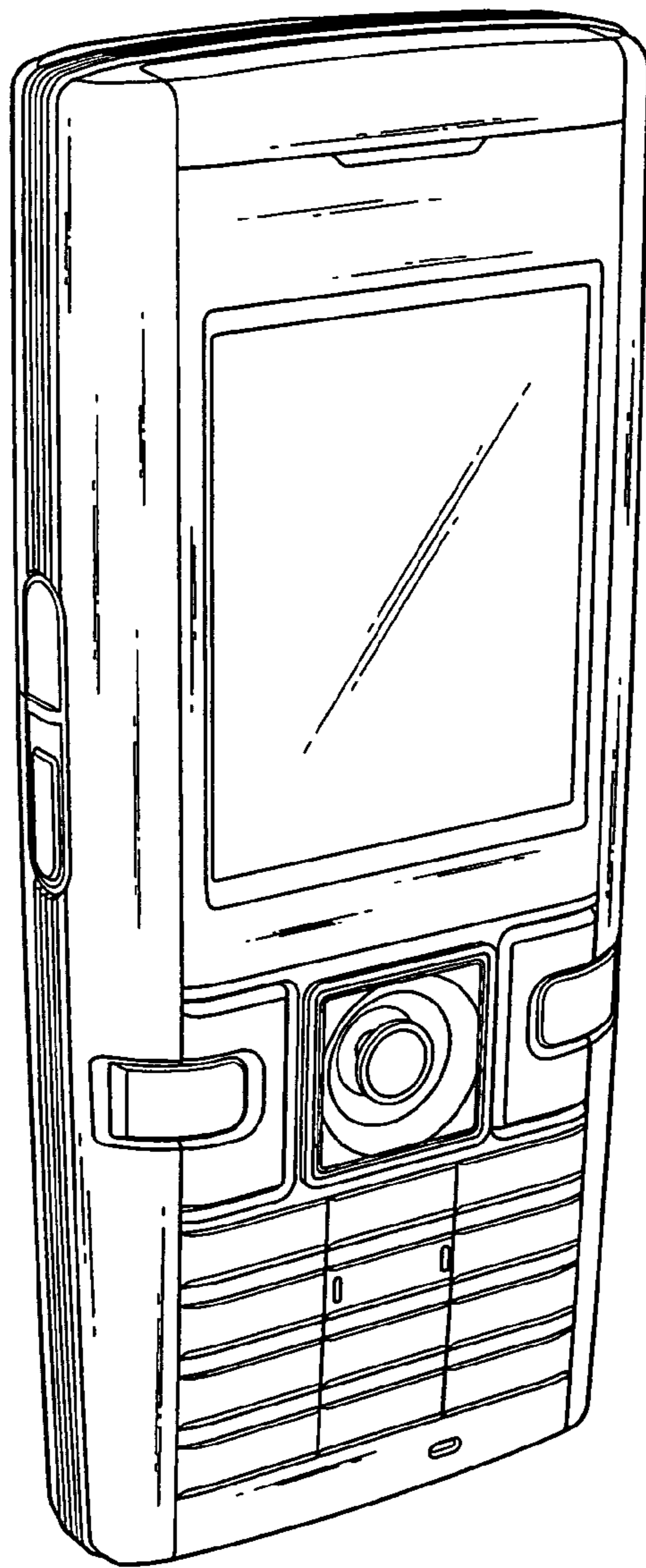

FIG. 2

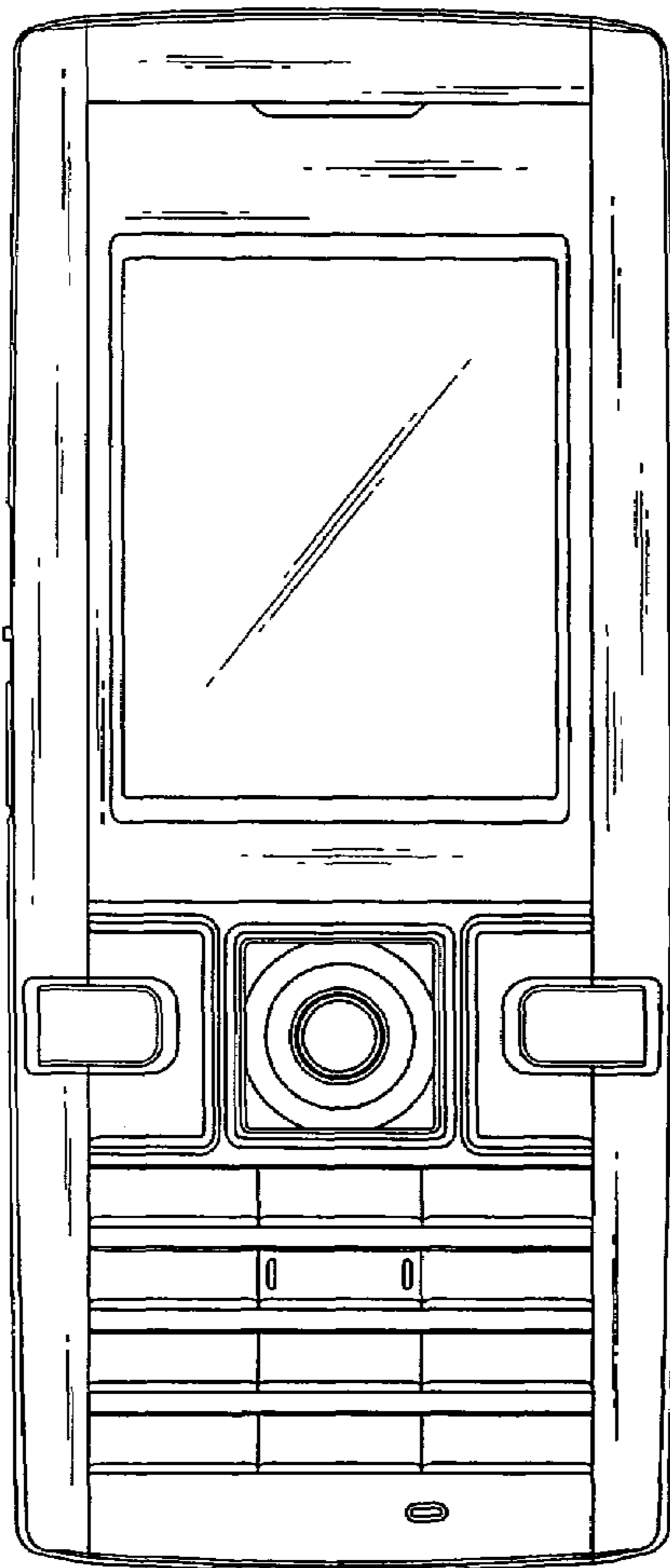

FIG. 3

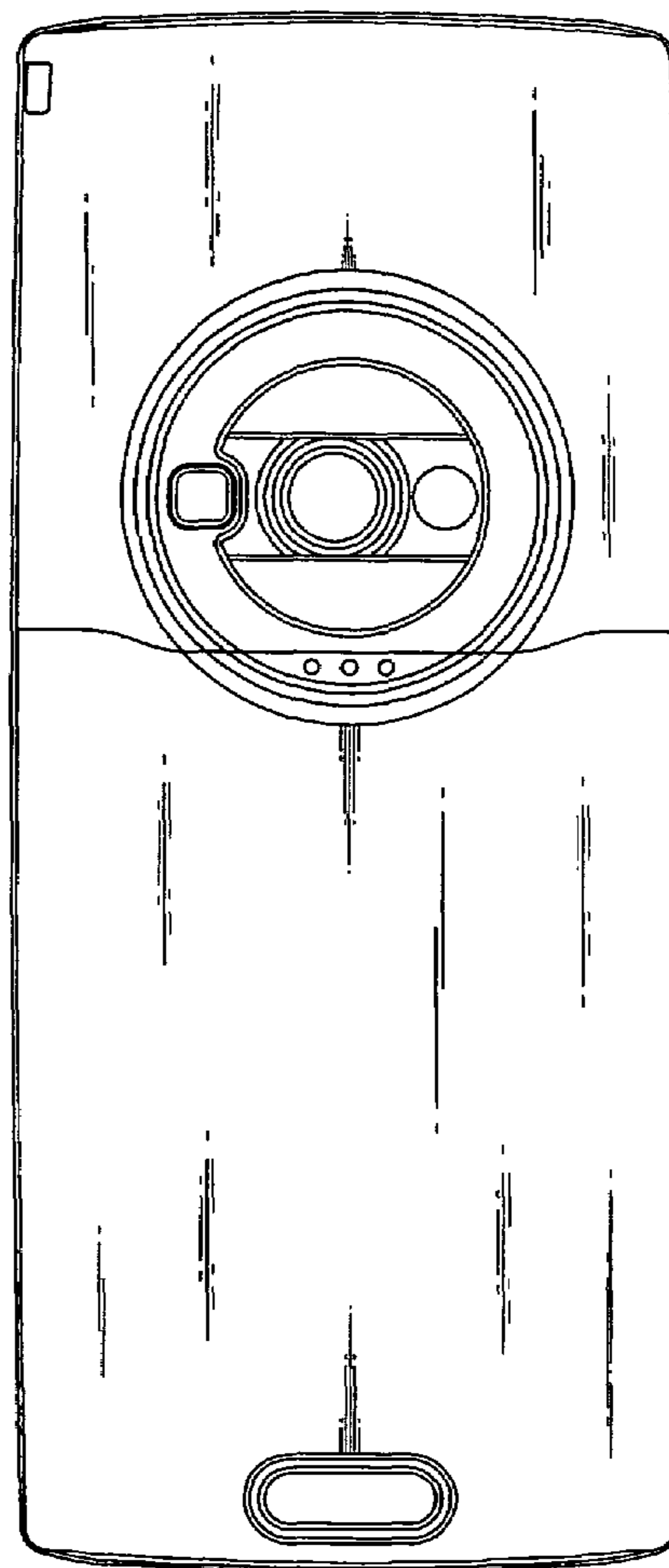

FIG. 4

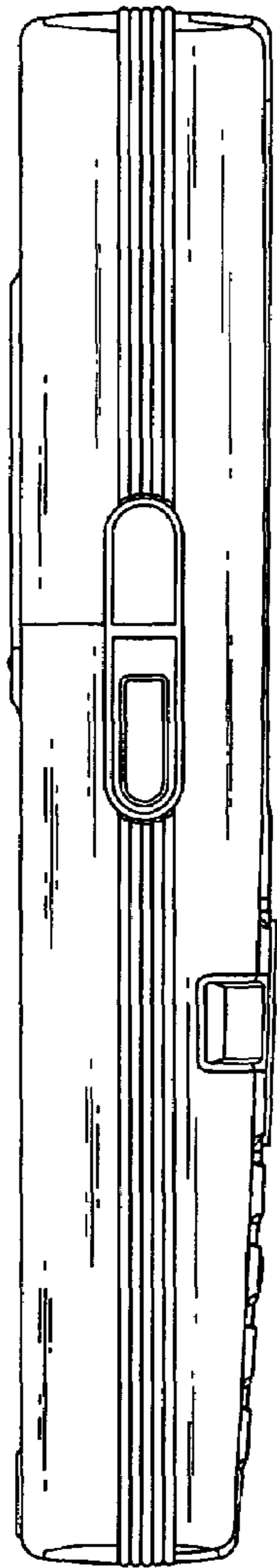

FIG. 5

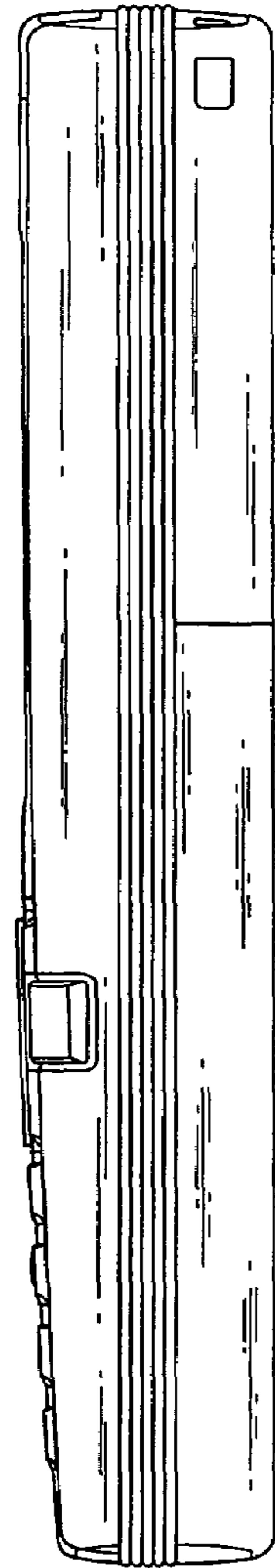

FIG. 6

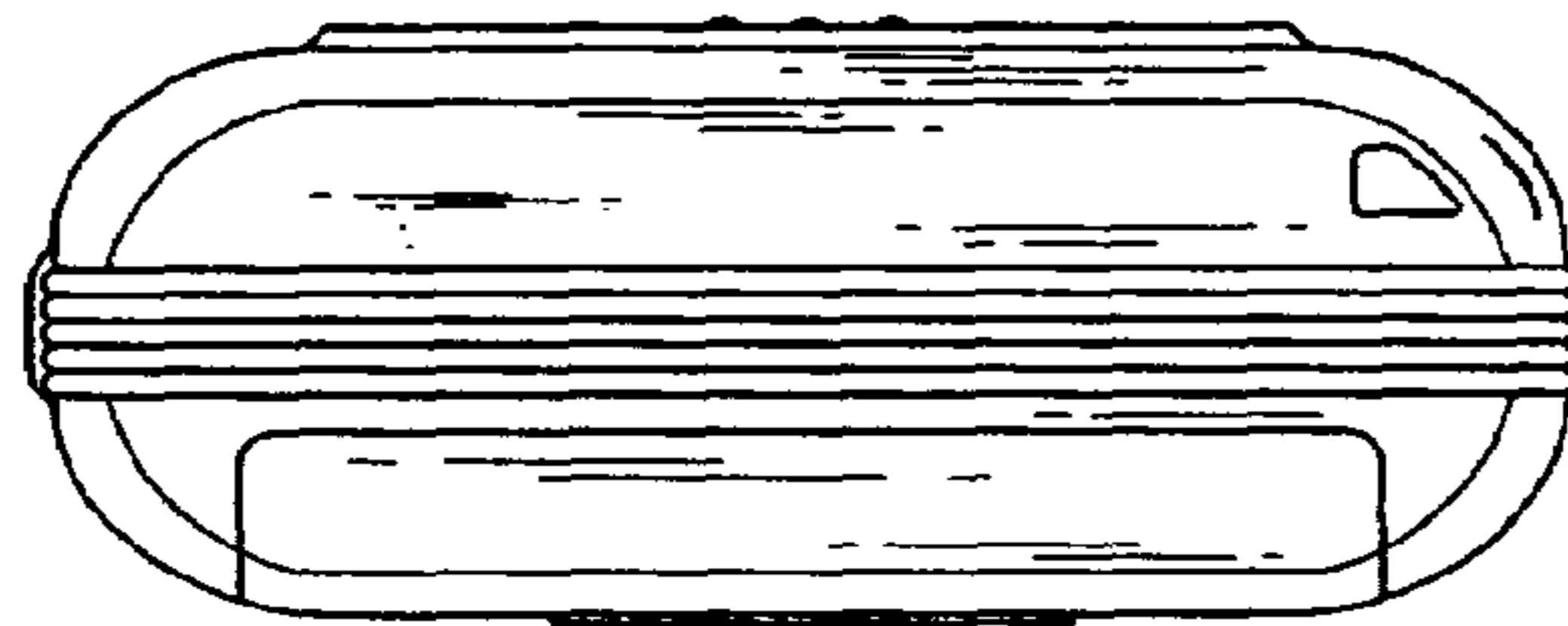

FIG. 7

