

US00D546287S

(12) **United States Design Patent**  
**Tanishita**

(10) **Patent No.:** **US D546,287 S**

(45) **Date of Patent:** **\*\* Jul. 10, 2007**

(54) **BATTERY CHARGER**

(75) Inventor: **Isamu Tanishita**, Shimada (JP)

(73) Assignee: **Topland Corporation**, Shimada-Shi,  
Shizuoka (JP)

(\*\*) Term: **14 Years**

(21) Appl. No.: **29/245,025**

(22) Filed: **Dec. 19, 2005**

(30) **Foreign Application Priority Data**

Jul. 21, 2005 (JP) ..... 2005-021196

(51) **LOC (8) Cl.** ..... **13-03**

(52) **U.S. Cl.** ..... **D13/144; D13/110**

(58) **Field of Classification Search** ..... D13/107,  
D13/108, 110, 144, 184; D14/155; 439/300,  
439/620, 638, 668-669, 675, 825; 320/110-112,  
320/114; 363/146

See application file for complete search history.

(56) **References Cited**

**U.S. PATENT DOCUMENTS**

- D330,887 S \* 11/1992 Wharton ..... D13/144
- D345,960 S \* 4/1994 Boyd et al. .... D13/144
- D348,250 S \* 6/1994 Shababy ..... D13/144
- D392,617 S \* 3/1998 Yokozawa ..... D13/144
- 5,847,545 A \* 12/1998 Chen et al. .... 320/138
- D406,261 S \* 3/1999 Kettula et al. .... D13/144
- D442,543 S \* 5/2001 Krumenacker et al. .... D13/107
- 6,324,086 B1 \* 11/2001 Hsieh ..... 363/146

- D455,712 S \* 4/2002 Hsiao ..... D13/108
- D456,007 S \* 4/2002 Kuo ..... D13/110
- D490,058 S \* 5/2004 Mkhitarian ..... D13/144
- D492,249 S \* 6/2004 Suomalainen et al. .... D13/108
- D494,542 S \* 8/2004 Hriscu et al. .... D13/110

\* cited by examiner

*Primary Examiner*—M. H. Tung

*Assistant Examiner*—Rosemary K. Tarcza

(74) *Attorney, Agent, or Firm*—Manabu Kanesaka

(57) **CLAIM**

The ornamental design for a battery charger, as shown and described.

**DESCRIPTION**

FIG. 1 is a front view of a battery charger showing my new design;

FIG. 2 is a rear view thereof;

FIG. 3 is a top plan view thereof;

FIG. 4 is a bottom view thereof;

FIG. 5 is a right side view thereof;

FIG. 6 is a left side view thereof; and

FIG. 7 is a sectional view thereof taken along line 7—7 in FIG. 3;

FIG. 8 is a perspective view thereof; and,

FIG. 9 is another perspective view from rear side and bottom in FIG. 7.

**1 Claim, 9 Drawing Sheets**

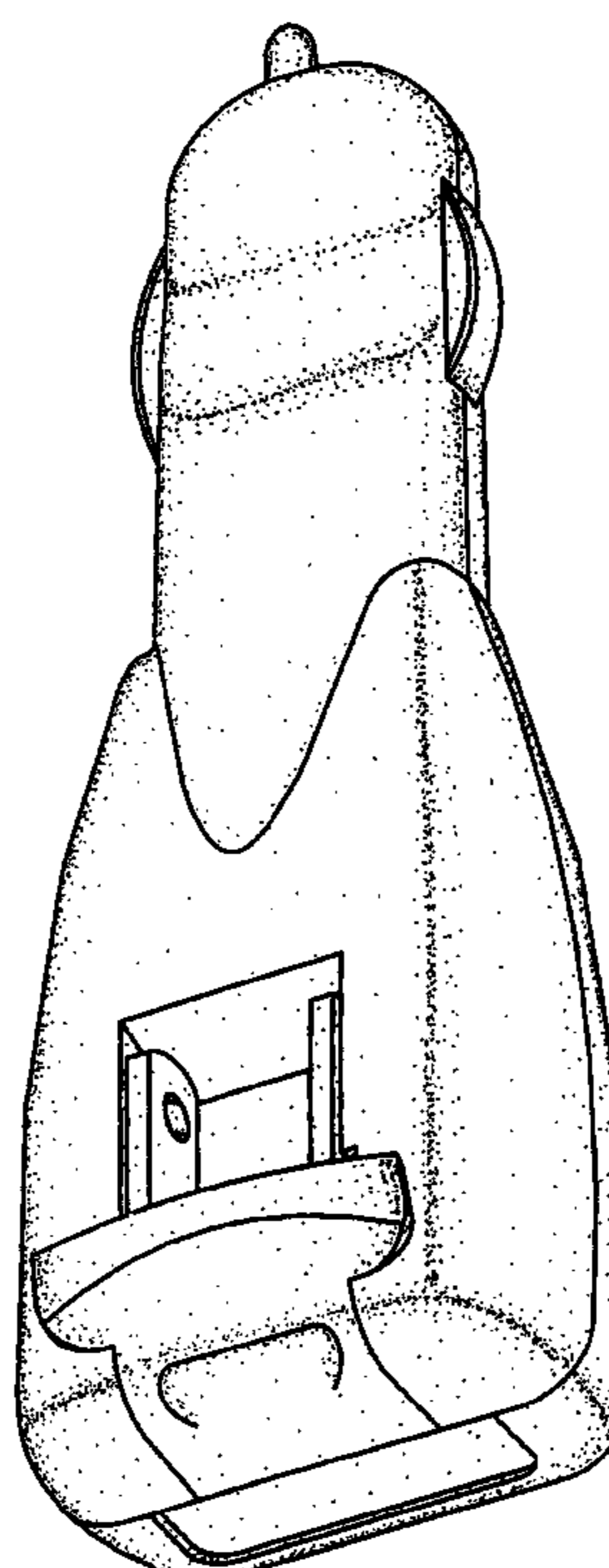
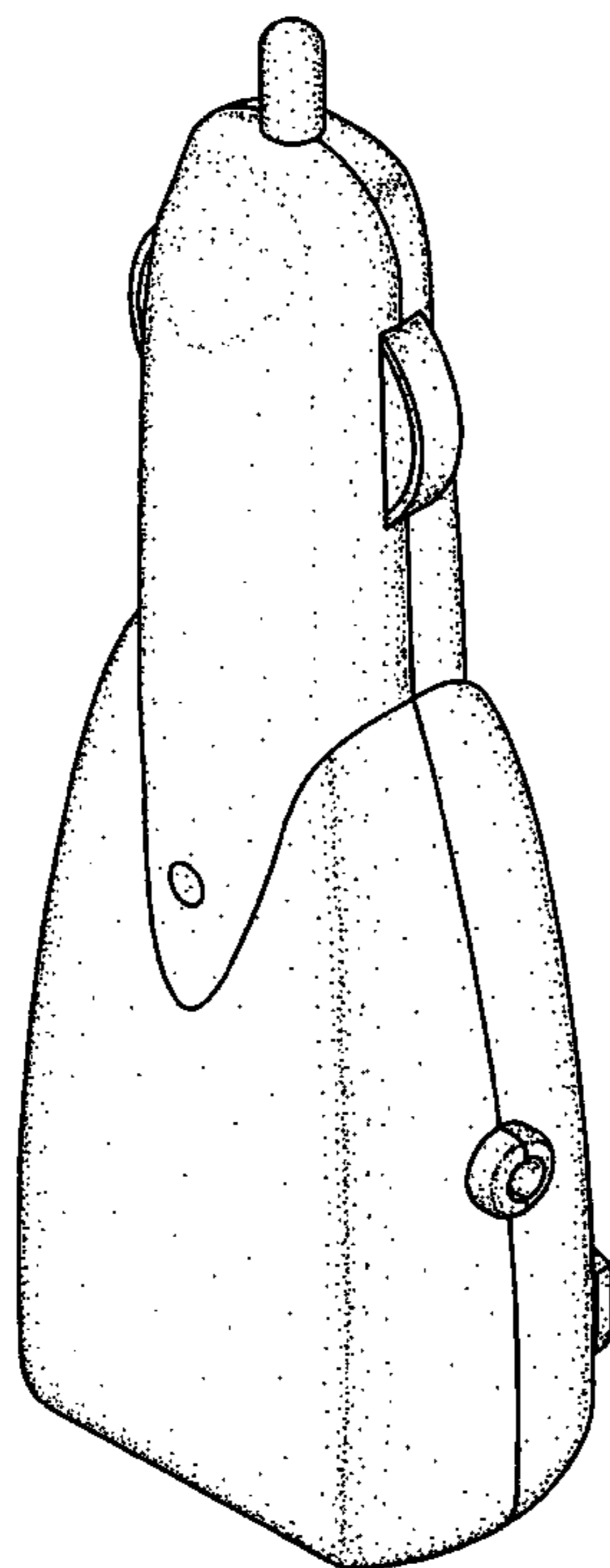

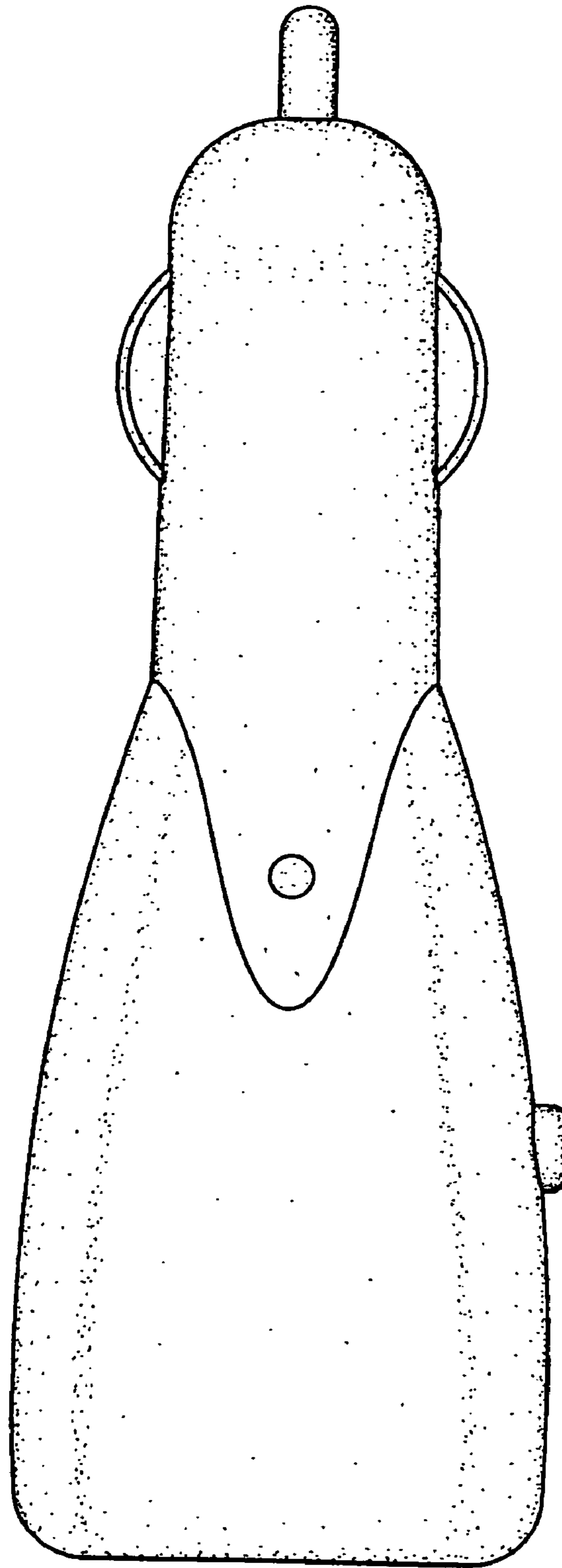

Fig. 1

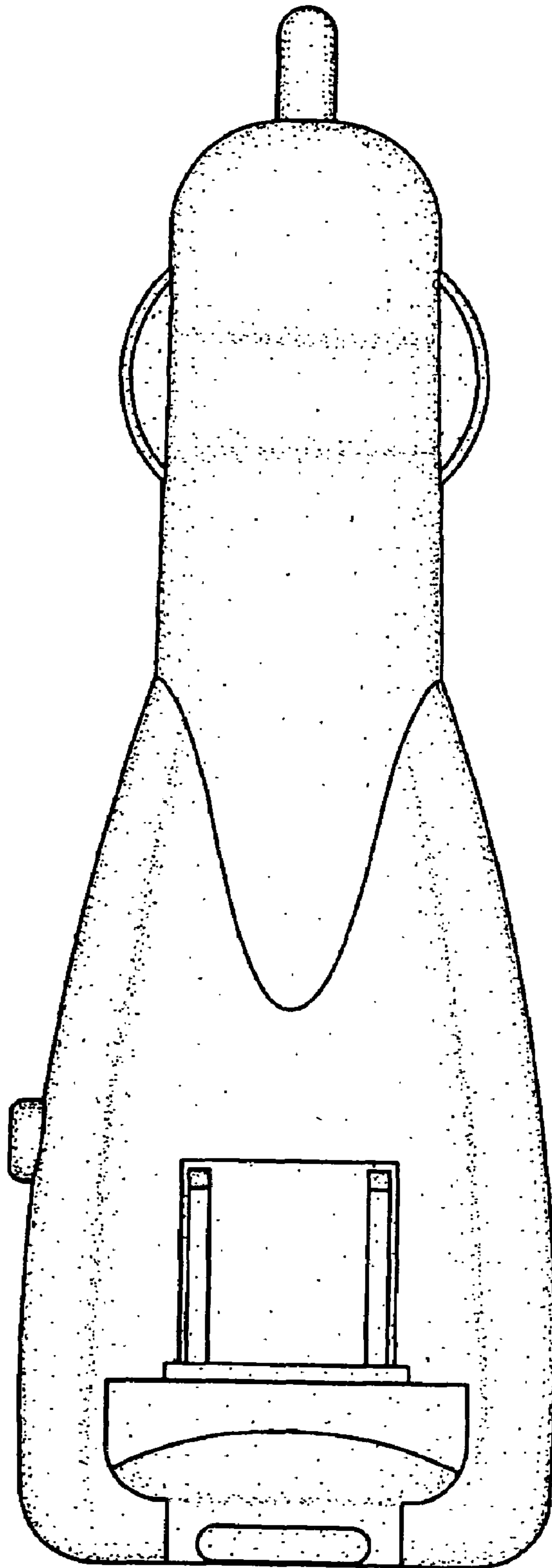

Fig. 2

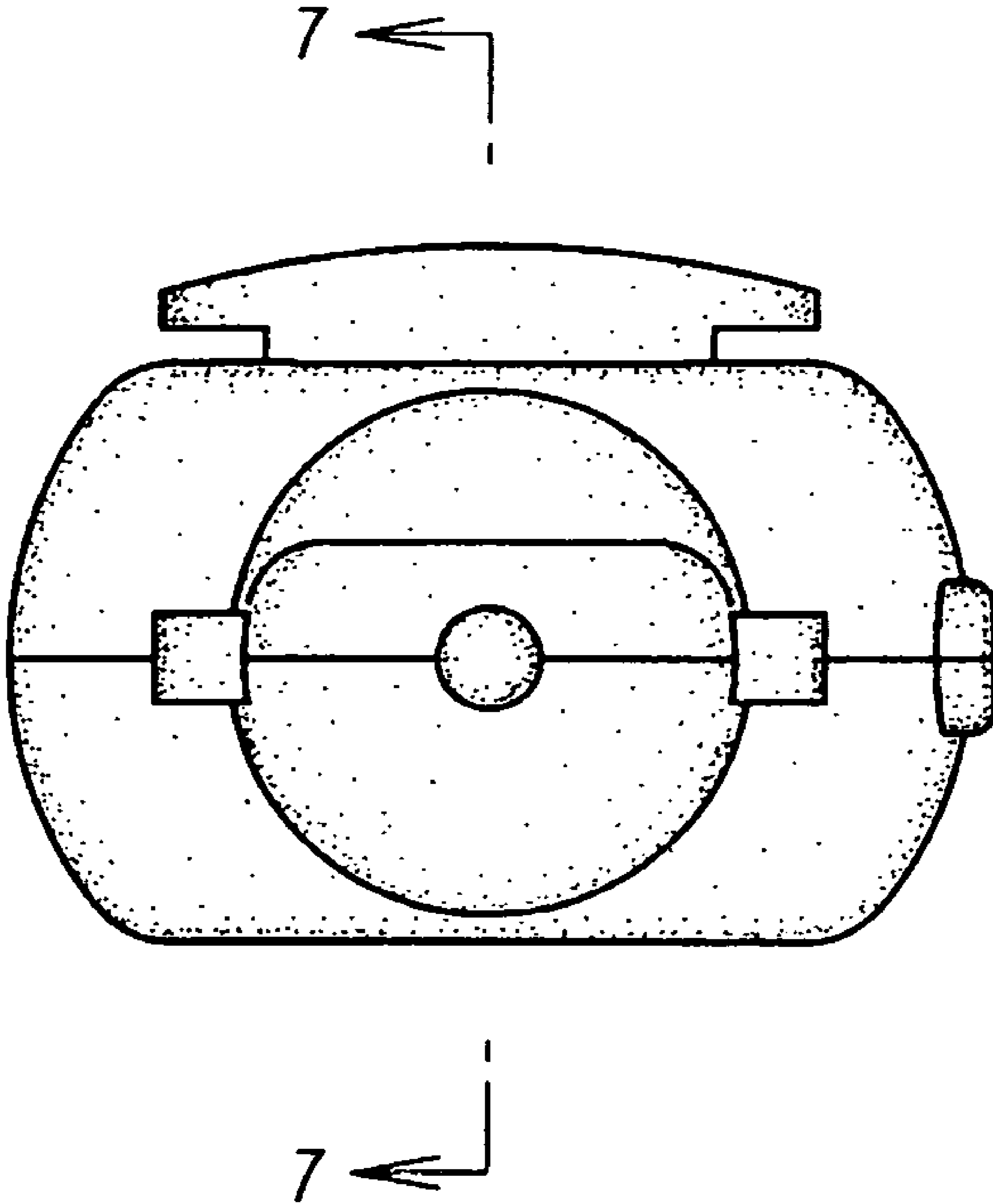

Fig. 3

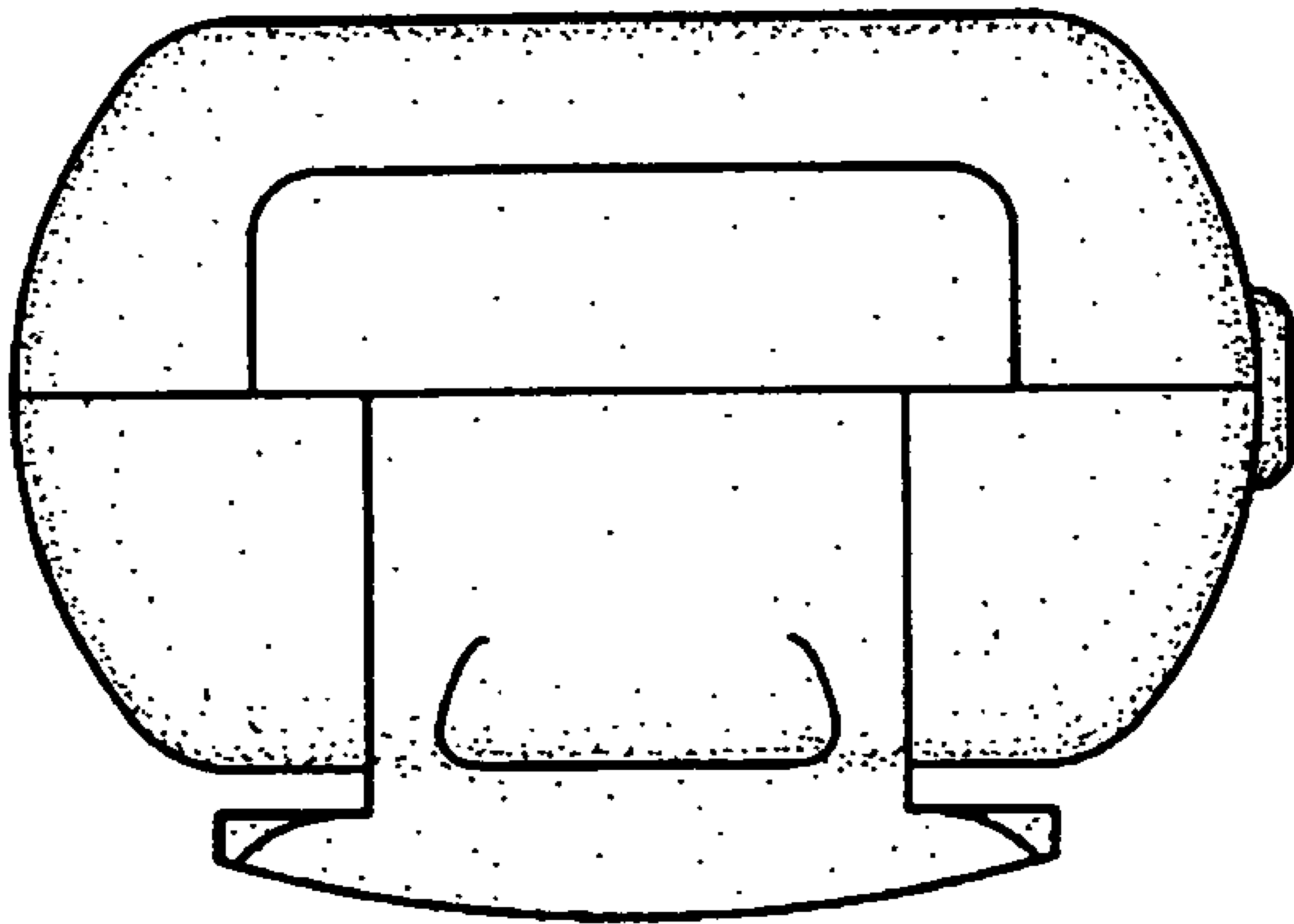

Fig. 4

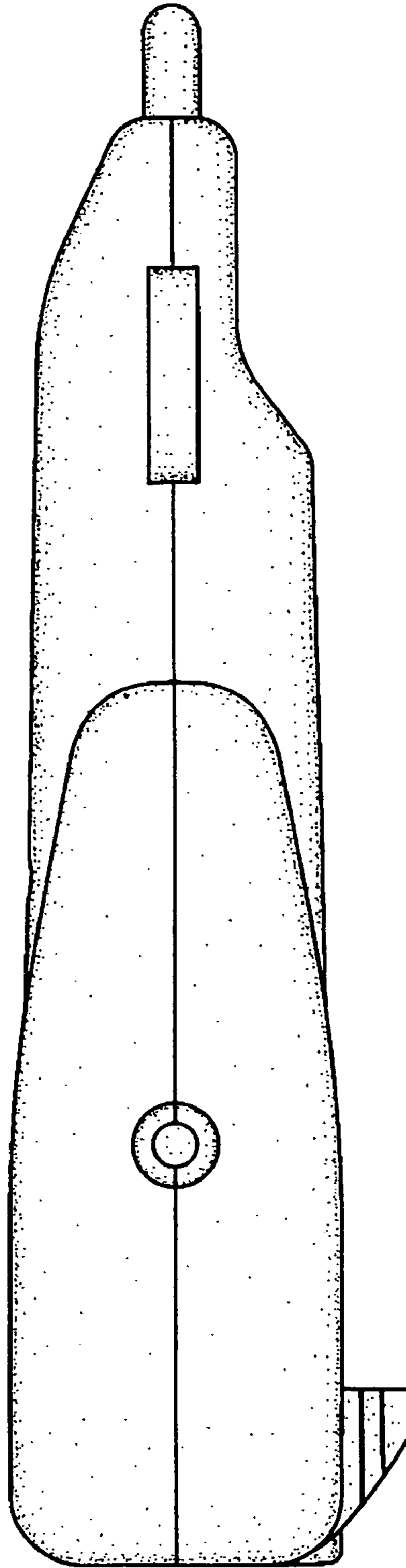

Fig. 5

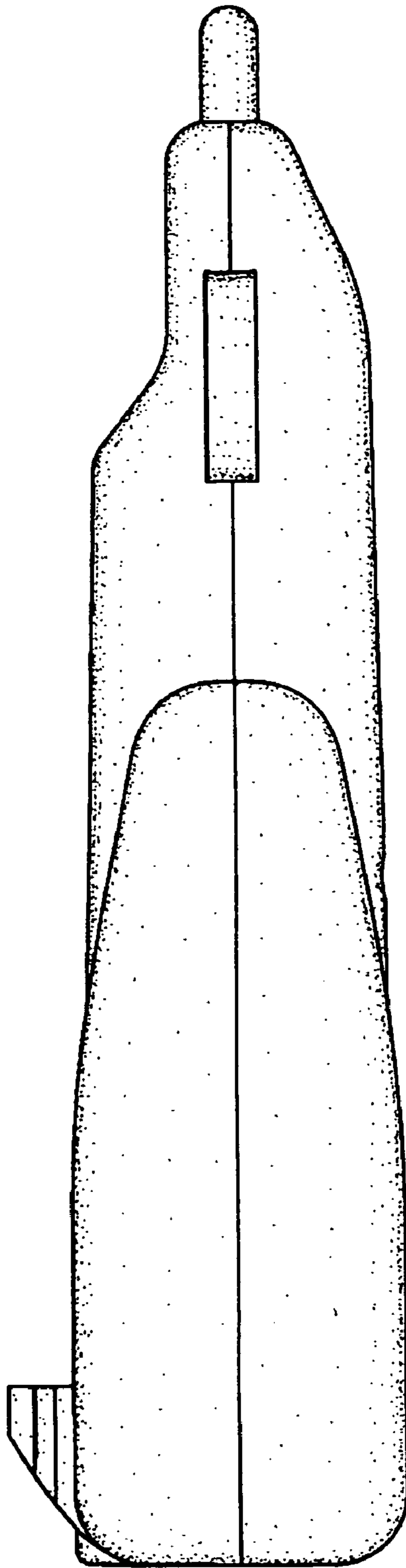

Fig. 6



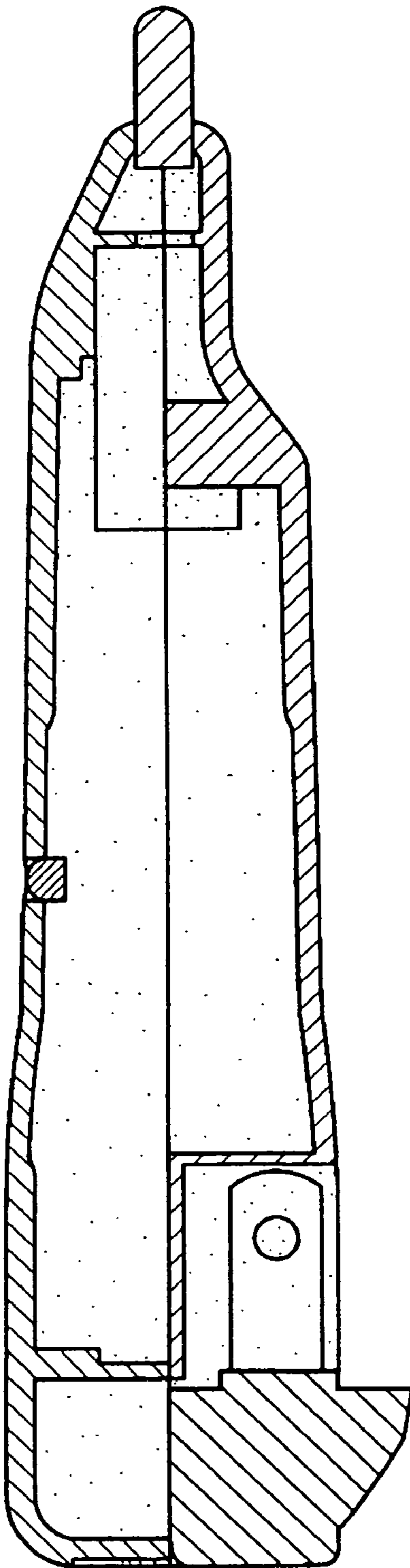

Fig. 7



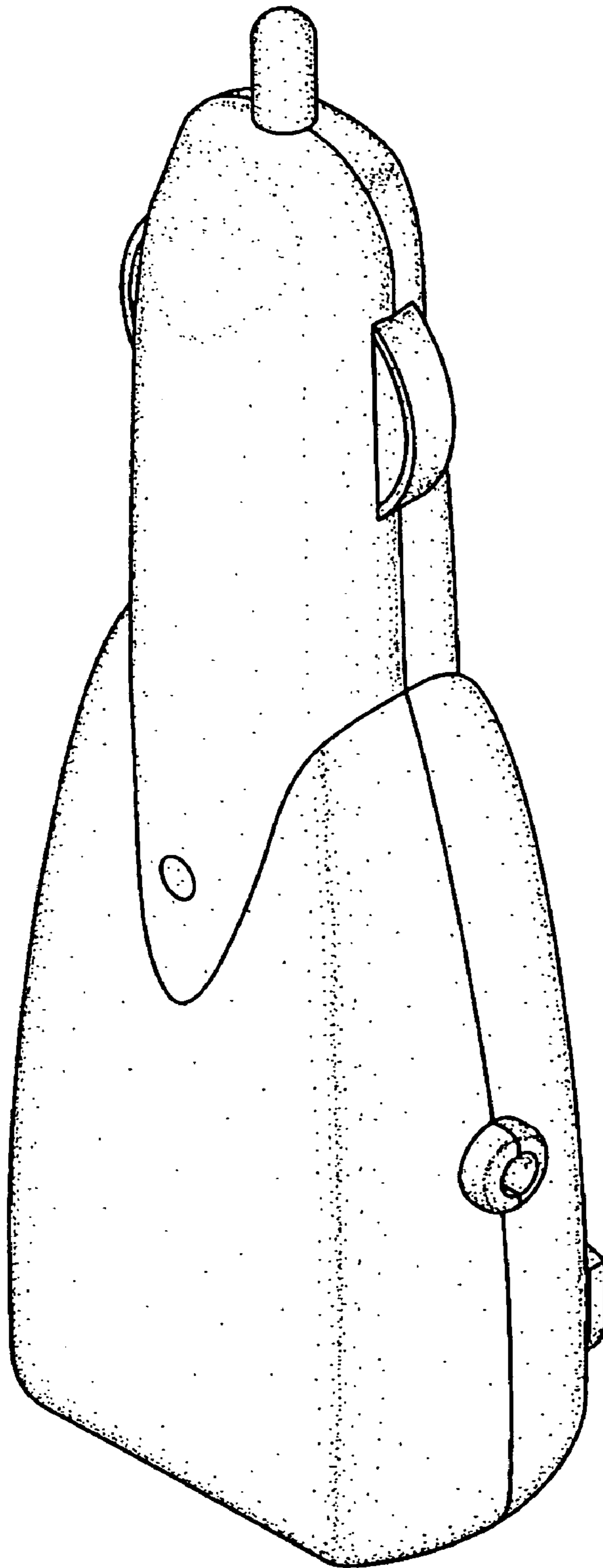

Fig. 8

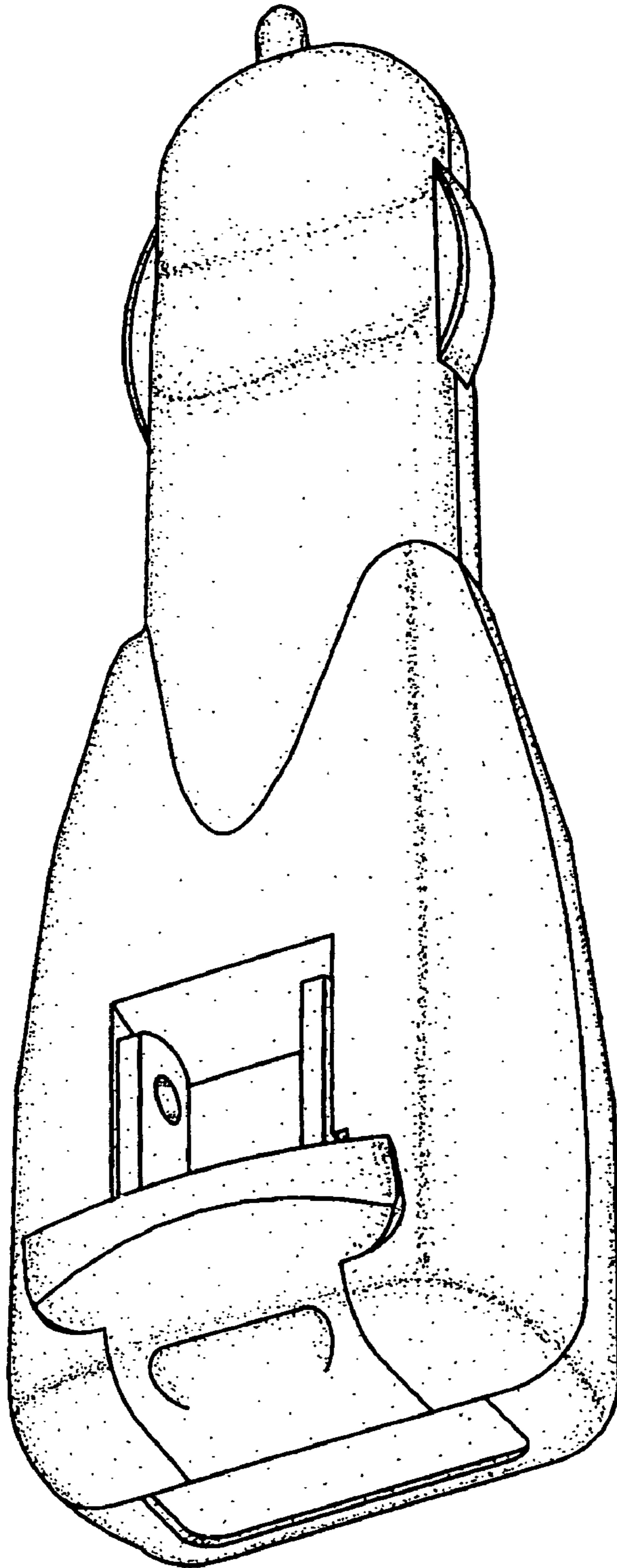

Fig. 9