

US00D546221S

(12) **United States Design Patent**
Barmes et al.

(10) **Patent No.:** **US D546,221 S**
(45) **Date of Patent:** **** Jul. 10, 2007**

(54) **SCALE**

(76) Inventors: **Nathan L. Barmes**, 145 Daleview Dr.,
Vincennes, IN (US) 47591; **Dustin P. Barmes**, 1171 N. Atkinson Rd.,
Vincennes, IN (US) 47591

(**) Term: **14 Years**

(21) Appl. No.: **29/259,904**

(22) Filed: **May 17, 2006**

(51) **LOC (8) Cl.** **10-04**

(52) **U.S. Cl.** **D10/91**

(58) **Field of Classification Search** D10/87-95;
177/4, 25.12-25.16, 177, 199, 210 R, 238-245,
177/DIG. 3, 262, 210 C, 30, 126-127; 324/692,
324/512, 515, 806; 600/506, 547
See application file for complete search history.

(56) **References Cited**

U.S. PATENT DOCUMENTS

- D470,782 S * 2/2003 Motomizu D10/92
- D472,833 S * 4/2003 Thadani D10/91
- D505,348 S * 5/2005 Lee D10/91
- D518,398 S * 4/2006 Kesselman D10/91
- D519,048 S * 4/2006 Kesselman D10/91
- D520,891 S * 5/2006 Motomizu et al. D10/91
- D521,889 S * 5/2006 Kesselman D10/91
- D521,890 S * 5/2006 Motomizu et al. D10/91

- D524,671 S * 7/2006 Huang D10/91
- D529,831 S * 10/2006 Malhi D10/91
- D531,075 S * 10/2006 Vantine D10/92

* cited by examiner

Primary Examiner—Antoine D. Davis

(74) *Attorney, Agent, or Firm*—Brinks Hofer Gilson & Lione

(57) **CLAIM**

The ornamental design for a scale, as shown and described.

DESCRIPTION

FIG. 1 is a top plan view of a scale of the present invention.
FIG. 2 is an elevation view of the scale as viewed from the
left side of FIG. 1.

FIG. 3 is an elevation view of the scale as viewed from the
right side of FIG. 1.

FIG. 4 is an elevation view of the scale as viewed from the
bottom of FIG. 1.

FIG. 5 is an elevation view of the scale as viewed from the
top of FIG. 1.

FIG. 6 is a bottom plan view of the scale shown in FIG. 1;
and,

FIG. 7 is a perspective view from the bottom right of FIG.
1.

1 Claim, 5 Drawing Sheets

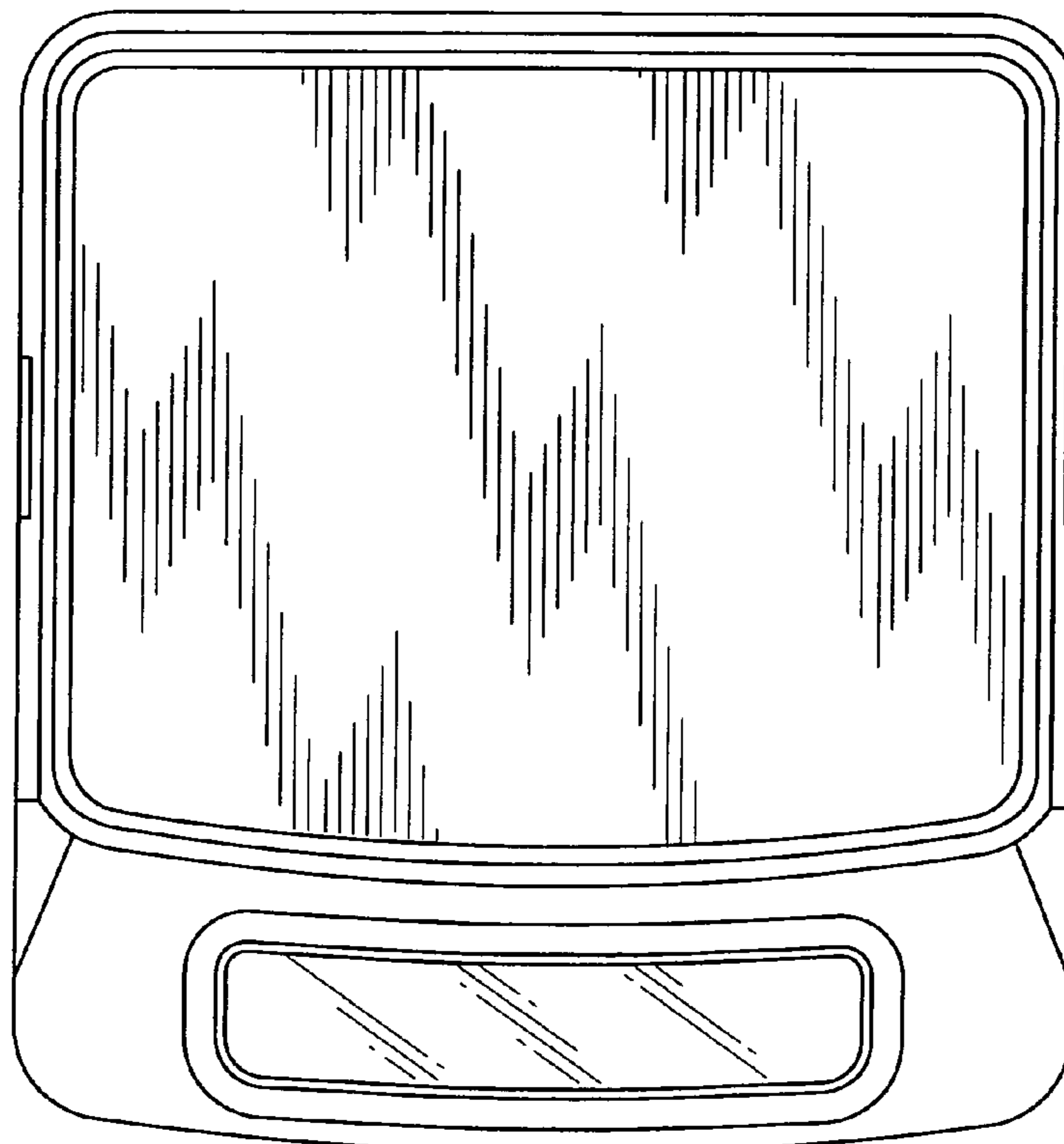

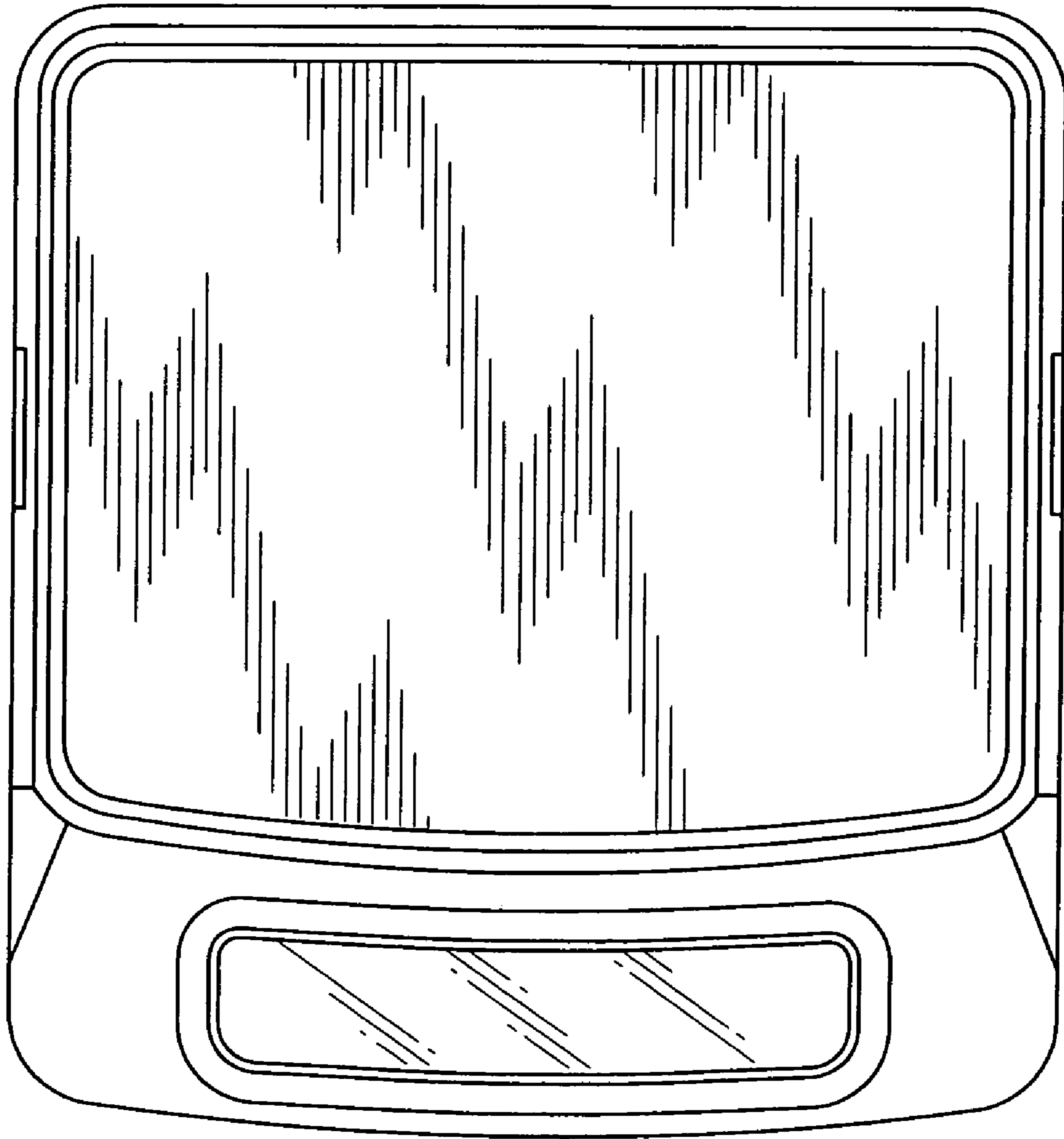

Fig. 1

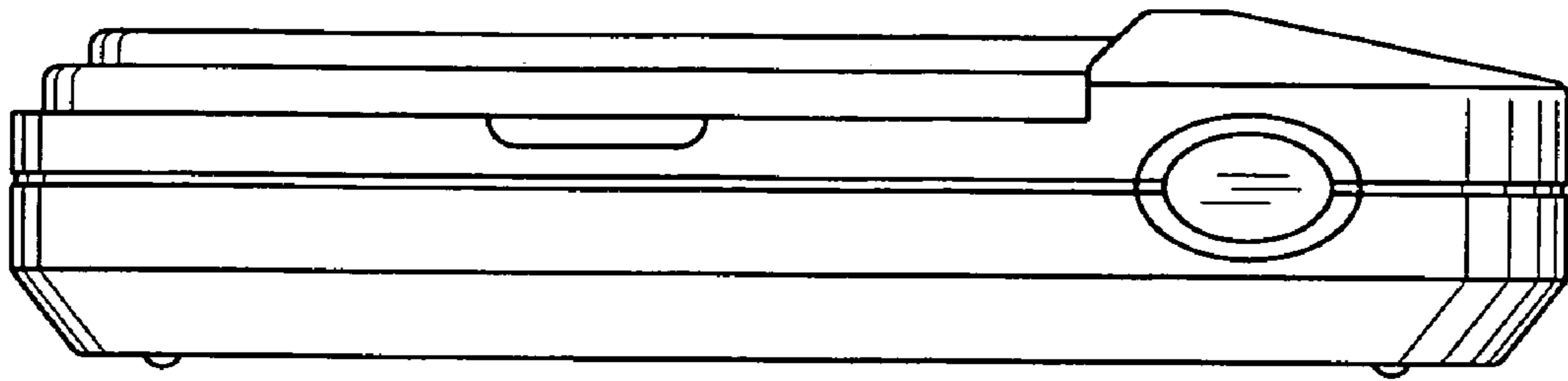

Fig. 2

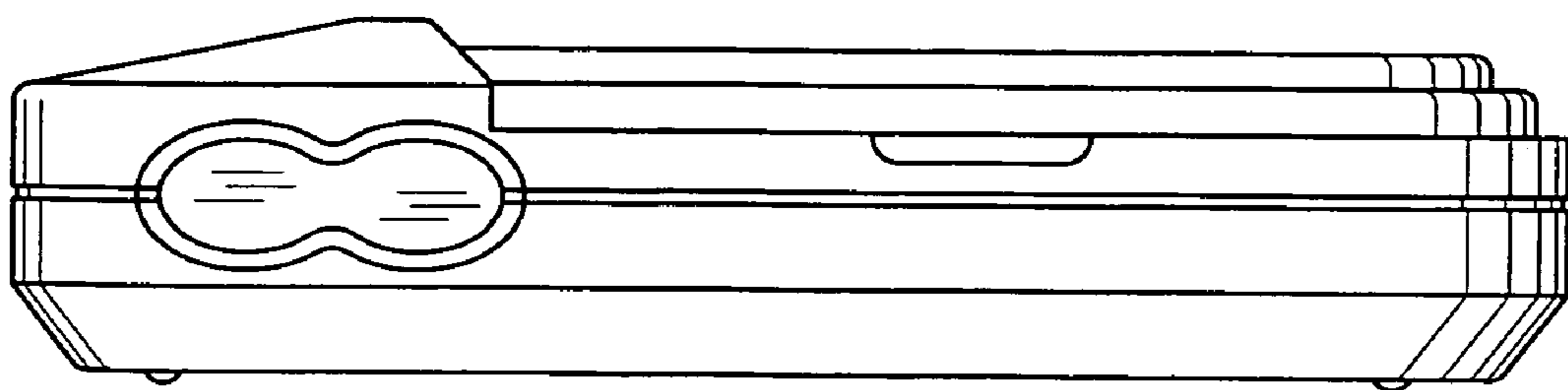

Fig. 3

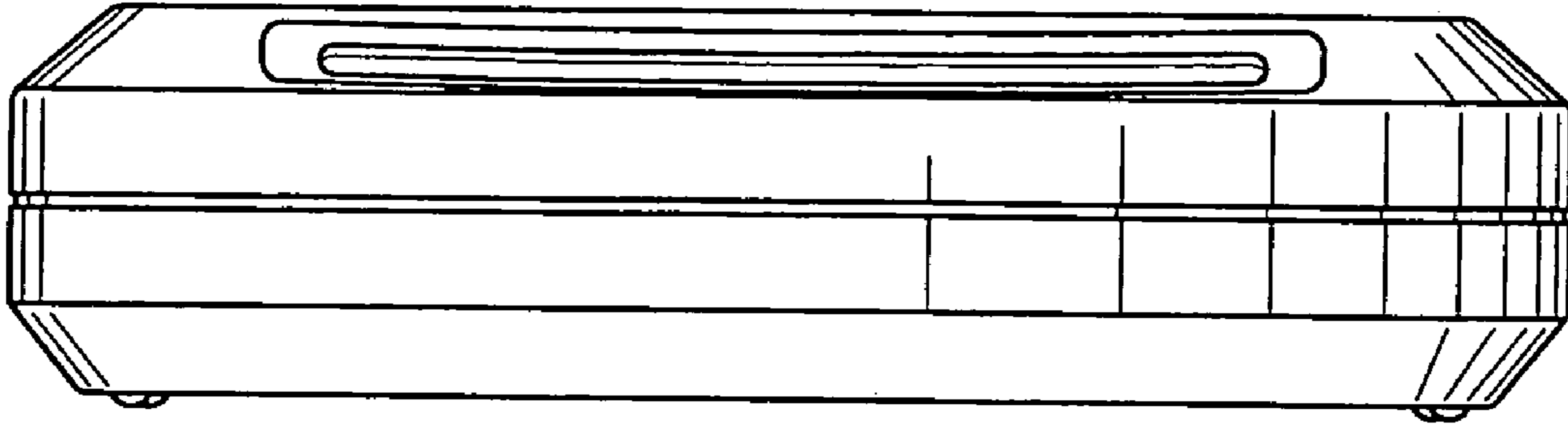

Fig. 4

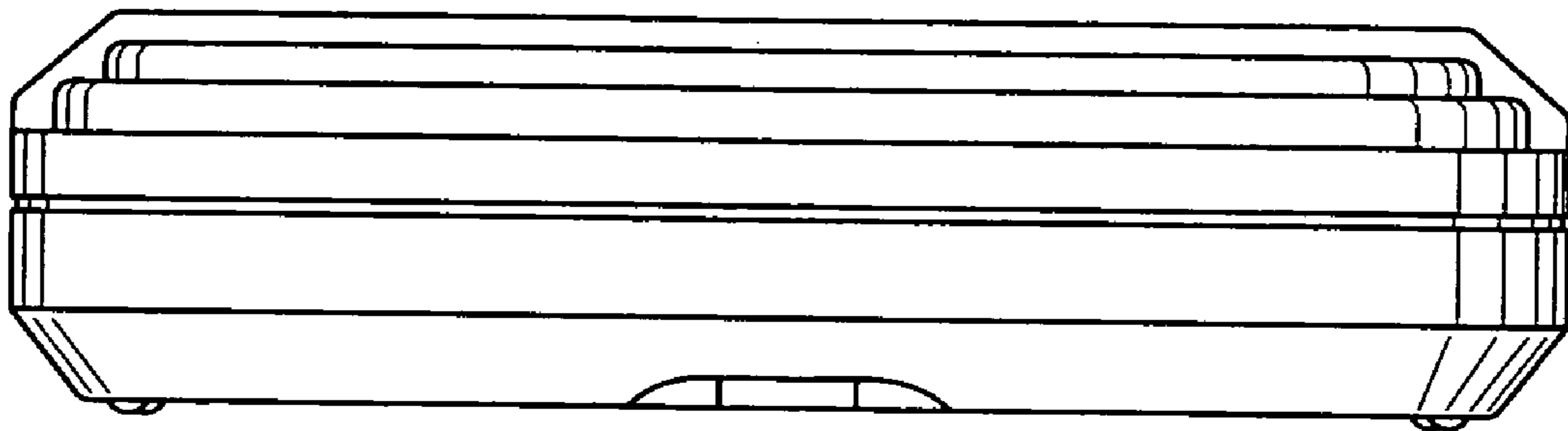

Fig. 5

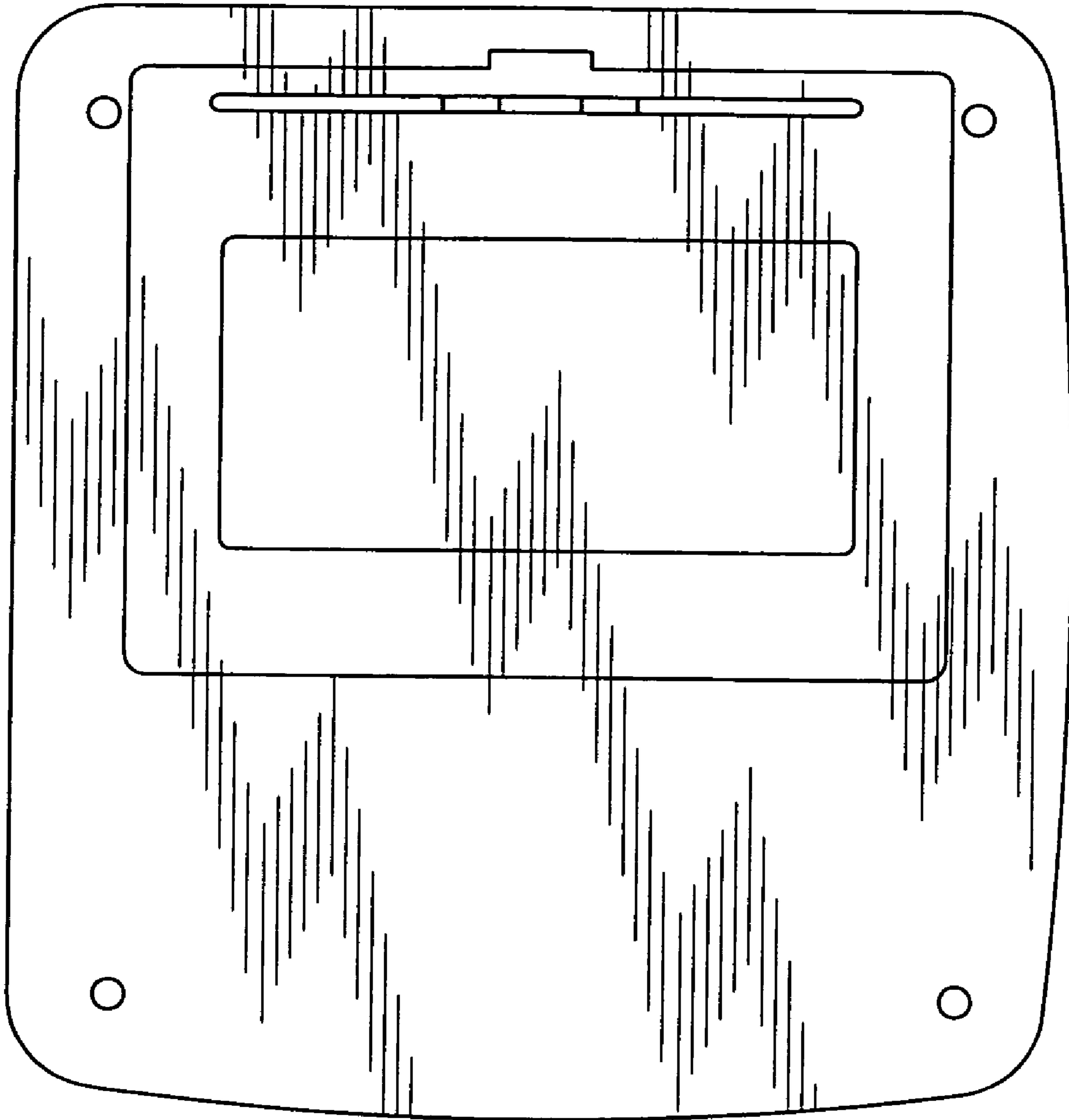

Fig. 6

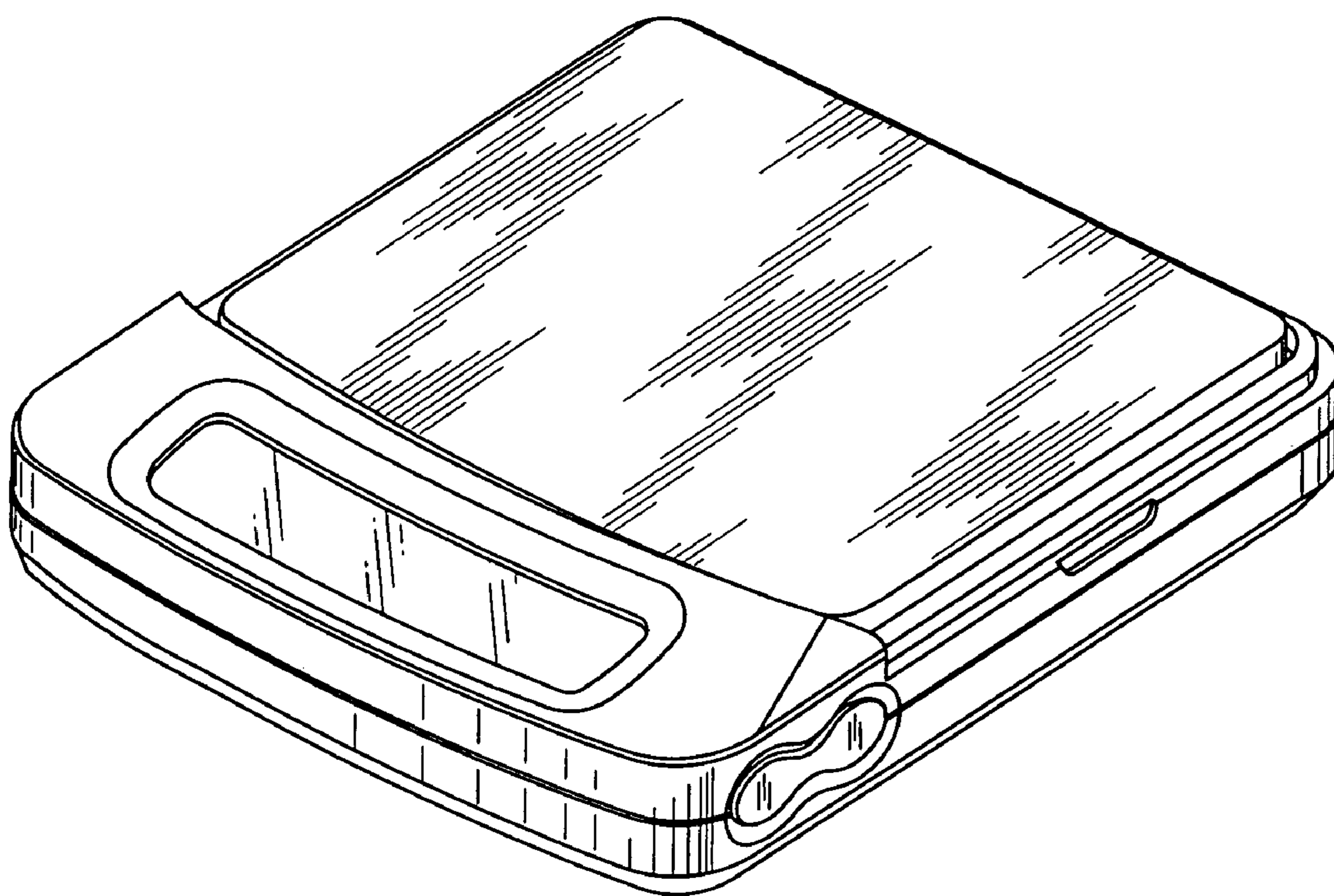

Fig. 7