

US00D546166S

(12) **United States Design Patent**  
**Liang**

(10) **Patent No.:** **US D546,166 S**

(45) **Date of Patent:** **\*\* Jul. 10, 2007**

(54) **SASH LOCK**

(57) **CLAIM**

(76) **Inventor:** **Luke Liang**, 30 Spruce Hollow Rd.,  
Green Brook, NJ (US) 08812

The ornamental design for a sash lock as shown and described.

(\*\*) **Term:** **14 Years**

**DESCRIPTION**

(21) **Appl. No.:** **29/223,091**

(22) **Filed:** **Feb. 7, 2005**

(51) **LOC (8) Cl.** ..... **08-07**

(52) **U.S. Cl.** ..... **D8/344**

(58) **Field of Classification Search** ..... D8/330-348;  
292/241, 242, 111, 83, 85; 70/89, 90  
See application file for complete search history.

FIG. 1 is a top view of the sash lock of the present invention where the hood of the sash lock covers the keeper.

FIG. 2 is a front view of the sash lock of the present invention showing the lock and the keeper.

FIG. 3 is a bottom view of the sash lock of FIG. 1.

FIG. 4 is a rear view of the sash lock of FIG. 1.

FIG. 5 is a left side view of the sash lock of FIG. 1.

FIG. 6 is a right side view of the sash lock of FIG. 1.

FIG. 7 is a rear perspective view of the sash lock of FIG. 1.

FIG. 8 is a front perspective view of the sash lock of FIG. 1.

FIG. 9 is a top view of an alternative embodiment of the sash lock of the present invention where hood of the sash lock does not cover the keeper.

FIG. 10 is a front view of the sash lock of FIG. 9.

FIG. 11 is a bottom view of the sash lock of FIG. 9.

FIG. 12 is an end view of the sash lock of FIG. 9.

FIG. 13 is a left side view of the sash lock of FIG. 9.

FIG. 14 is a right side view of the sash lock of FIG. 9; and,

FIG. 15 is a perspective view of the sash lock of FIG. 9.

(56) **References Cited**

**U.S. PATENT DOCUMENTS**

D293,548 S *	1/1988	Bates et al. ....	D8/337
D380,957 S *	7/1997	Evans et al. ....	D8/337
D382,191 S *	8/1997	Plummer ....	D8/337
D382,192 S *	8/1997	Plummer ....	D8/337
D408,263 S *	4/1999	Briggs ....	D8/337
D418,737 S *	1/2000	Libby et al. ....	D8/337
6,871,886 B2 *	3/2005	Coleman et al. ....	292/241
7,000,957 B2 *	2/2006	Lawrence ....	292/241
7,159,908 B2 *	1/2007	Liang ....	292/242
2001/0005995 A1 *	7/2001	Subliskey ....	70/89

\* cited by examiner

*Primary Examiner*—Mitchell Siegel

(74) *Attorney, Agent, or Firm*—Thomas A. O'Rourke;  
Bodner & O'Rourke

**1 Claim, 5 Drawing Sheets**

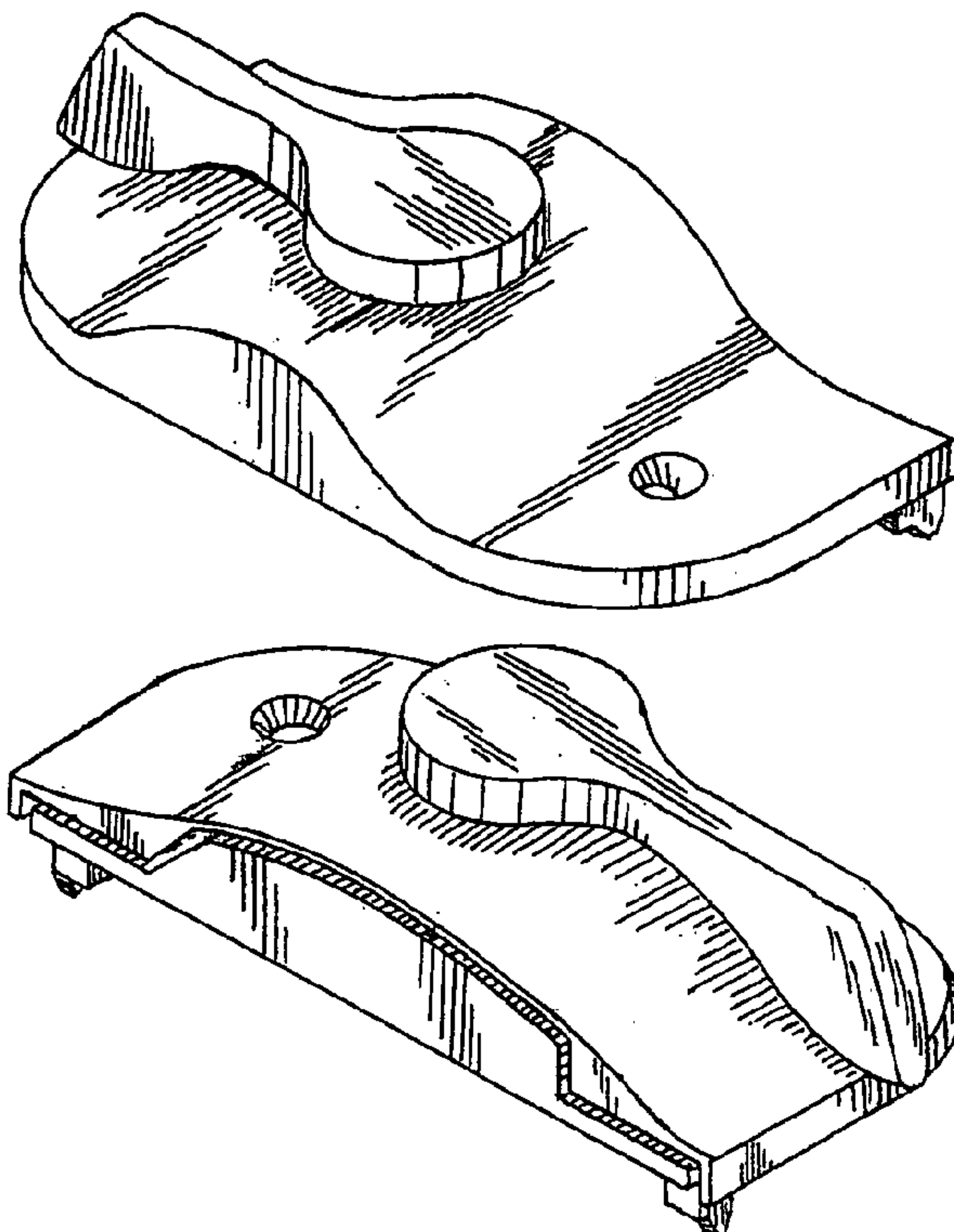

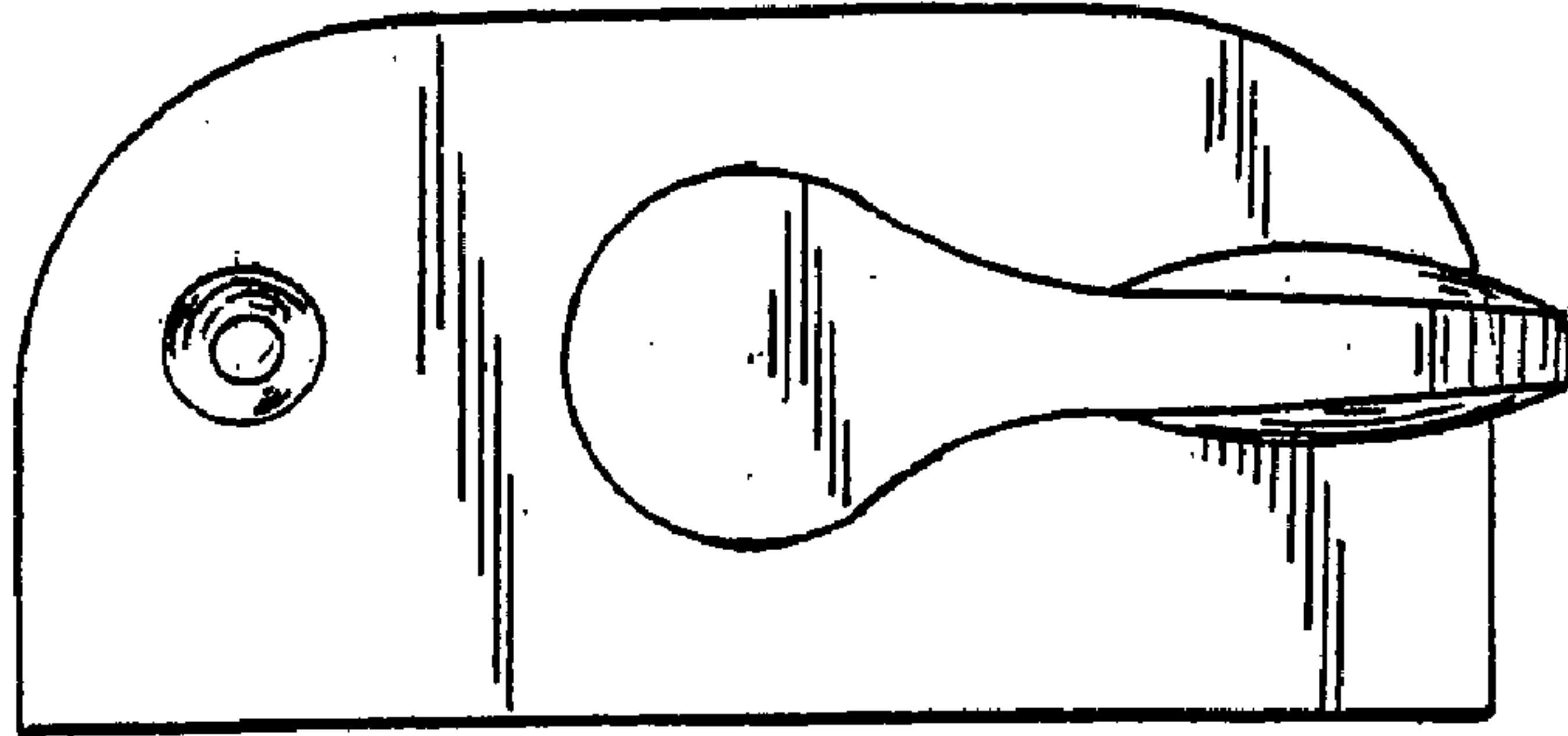

FIG. 1

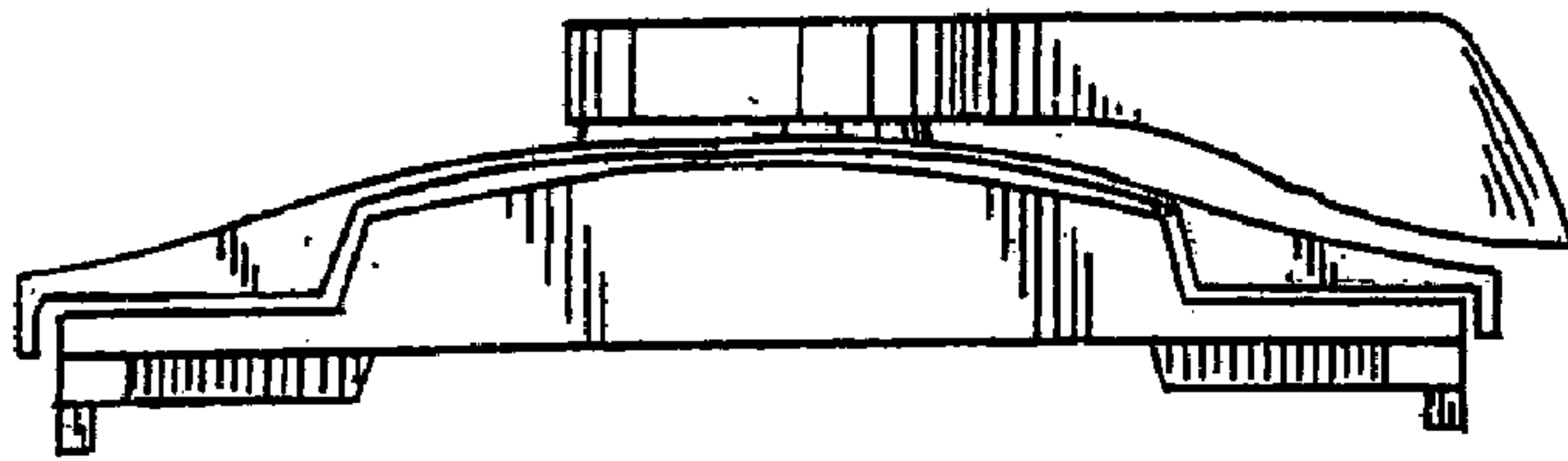

FIG. 2

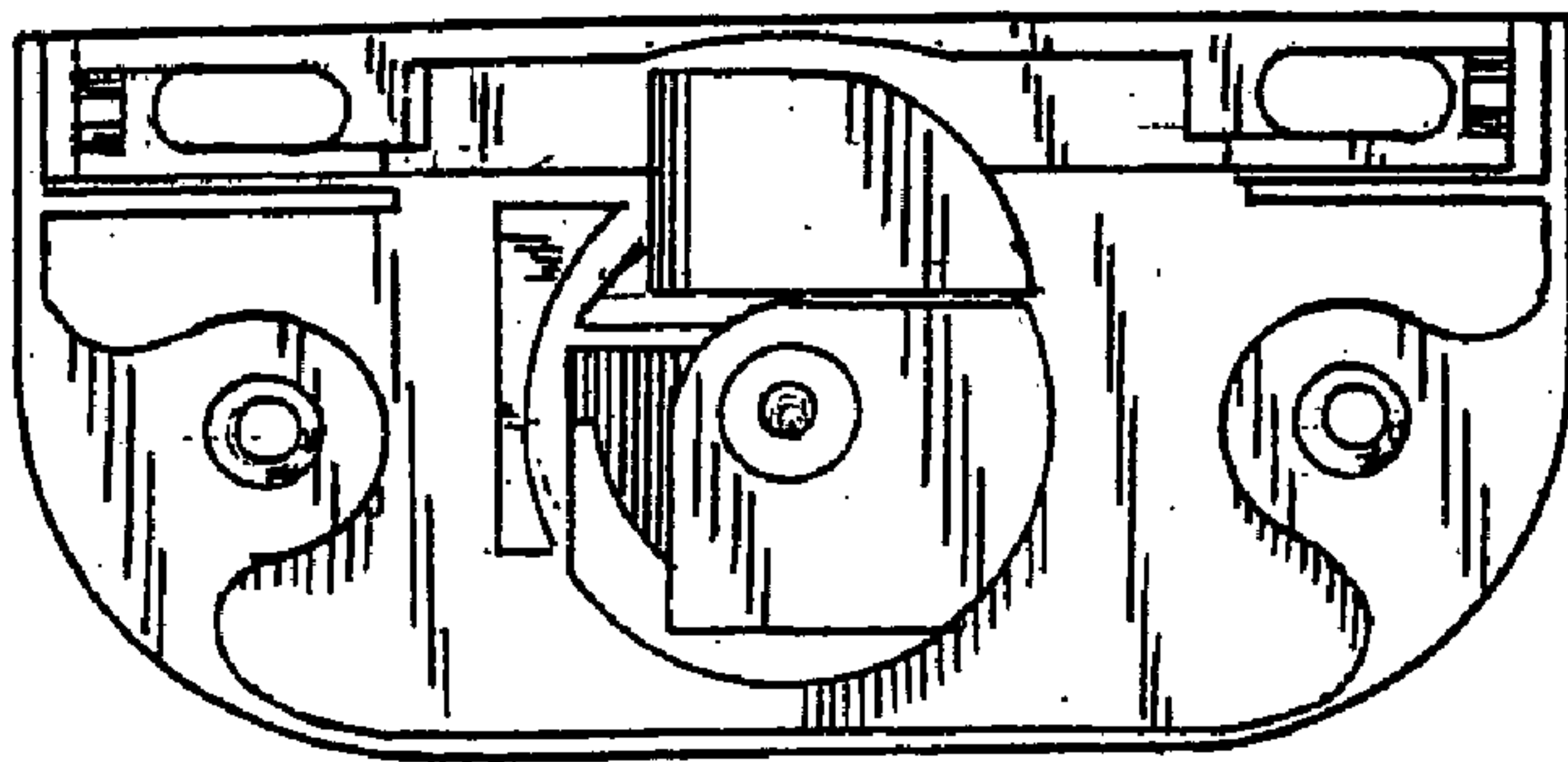

FIG. 3

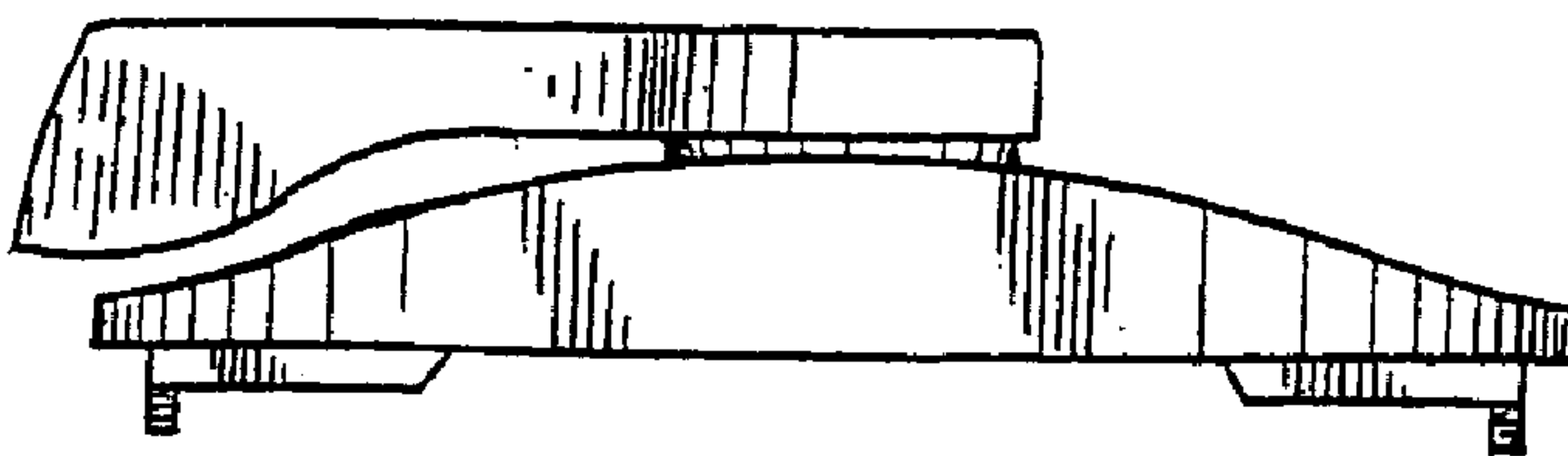

FIG. 4

FIG. 5

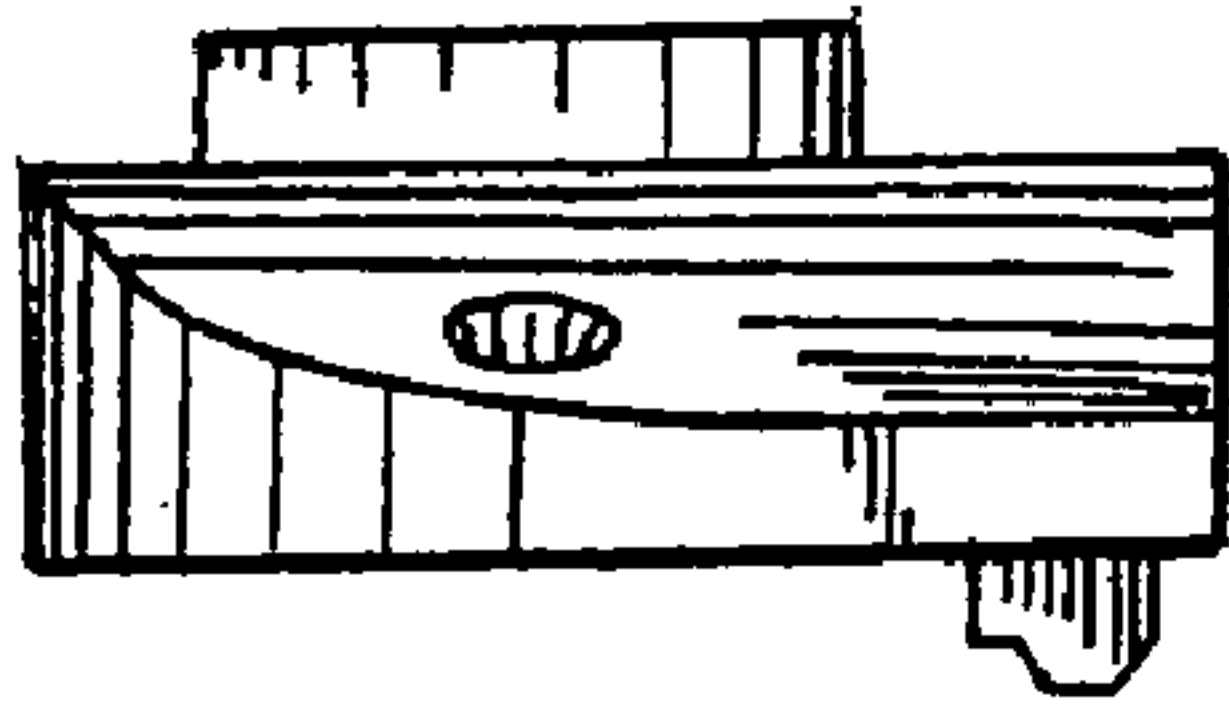

FIG. 6

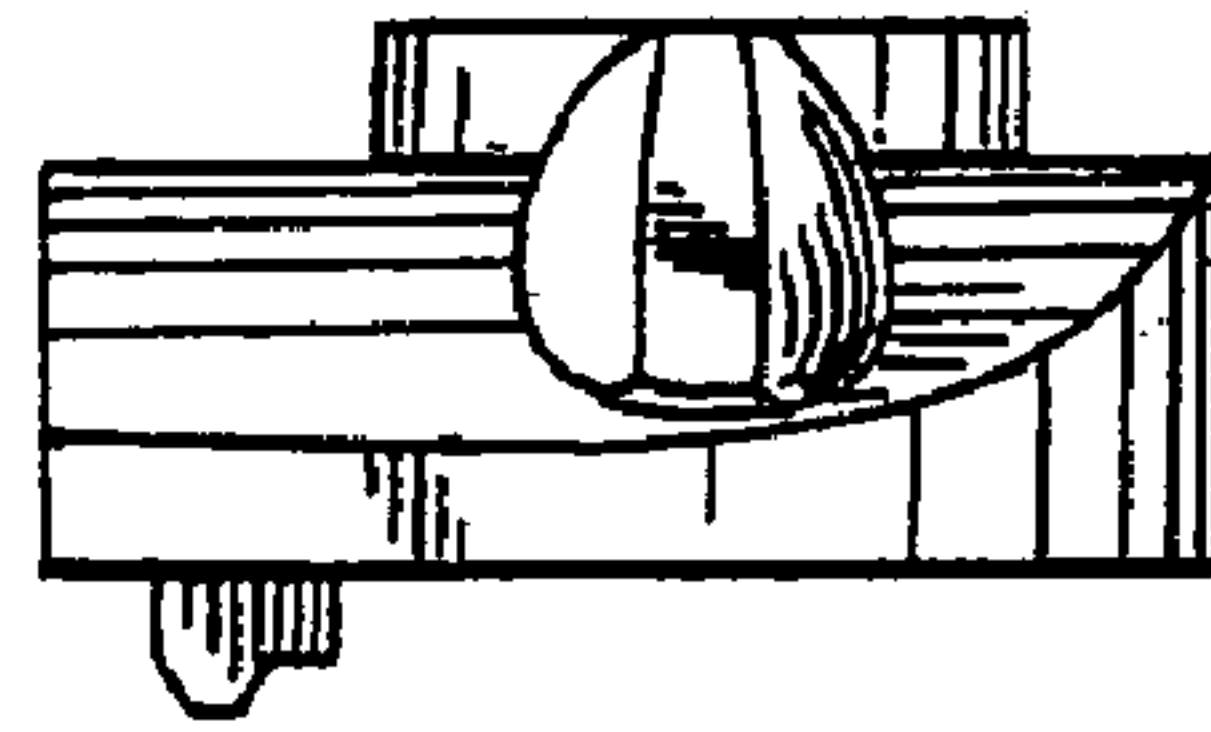

FIG. 7

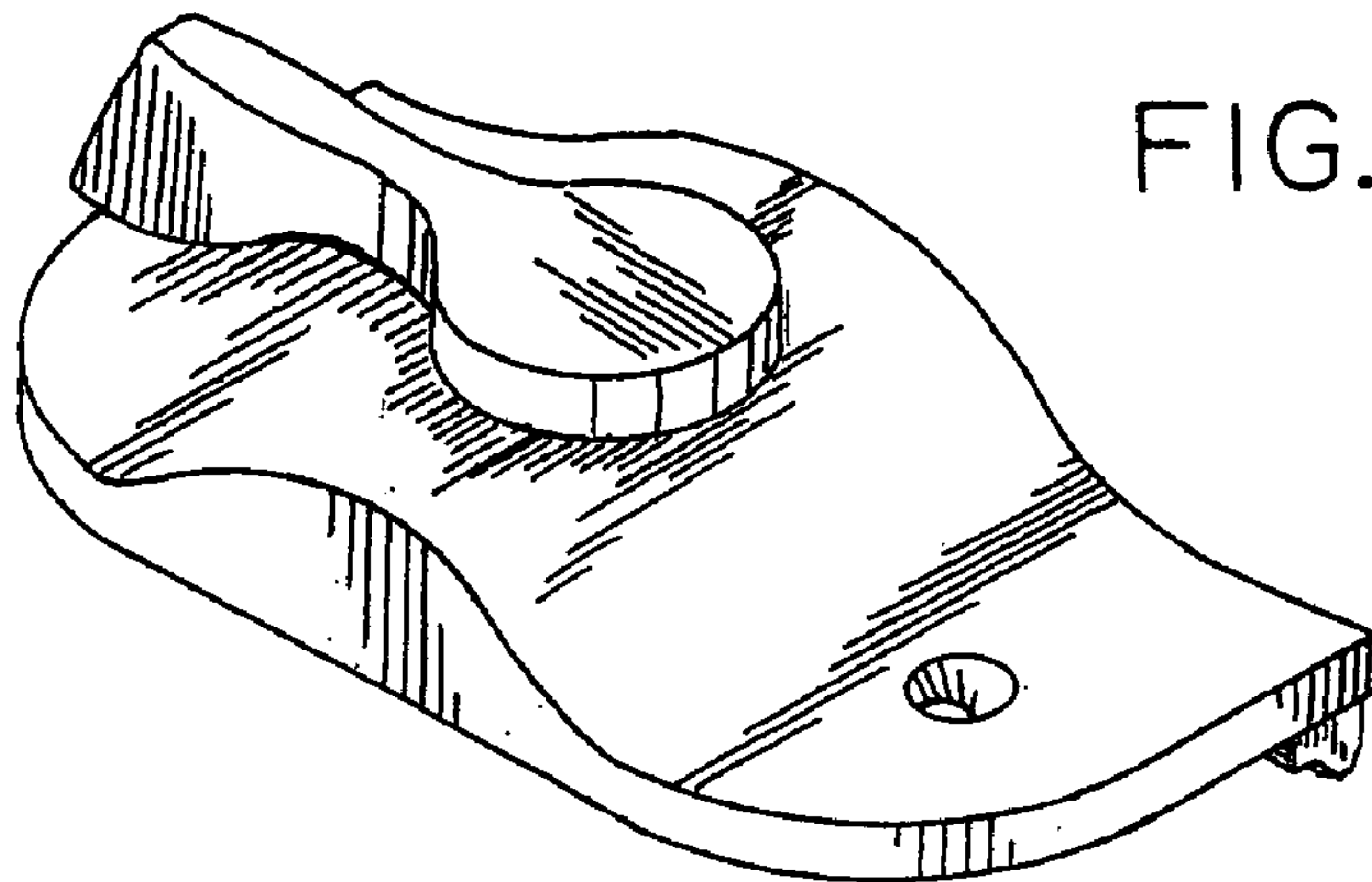
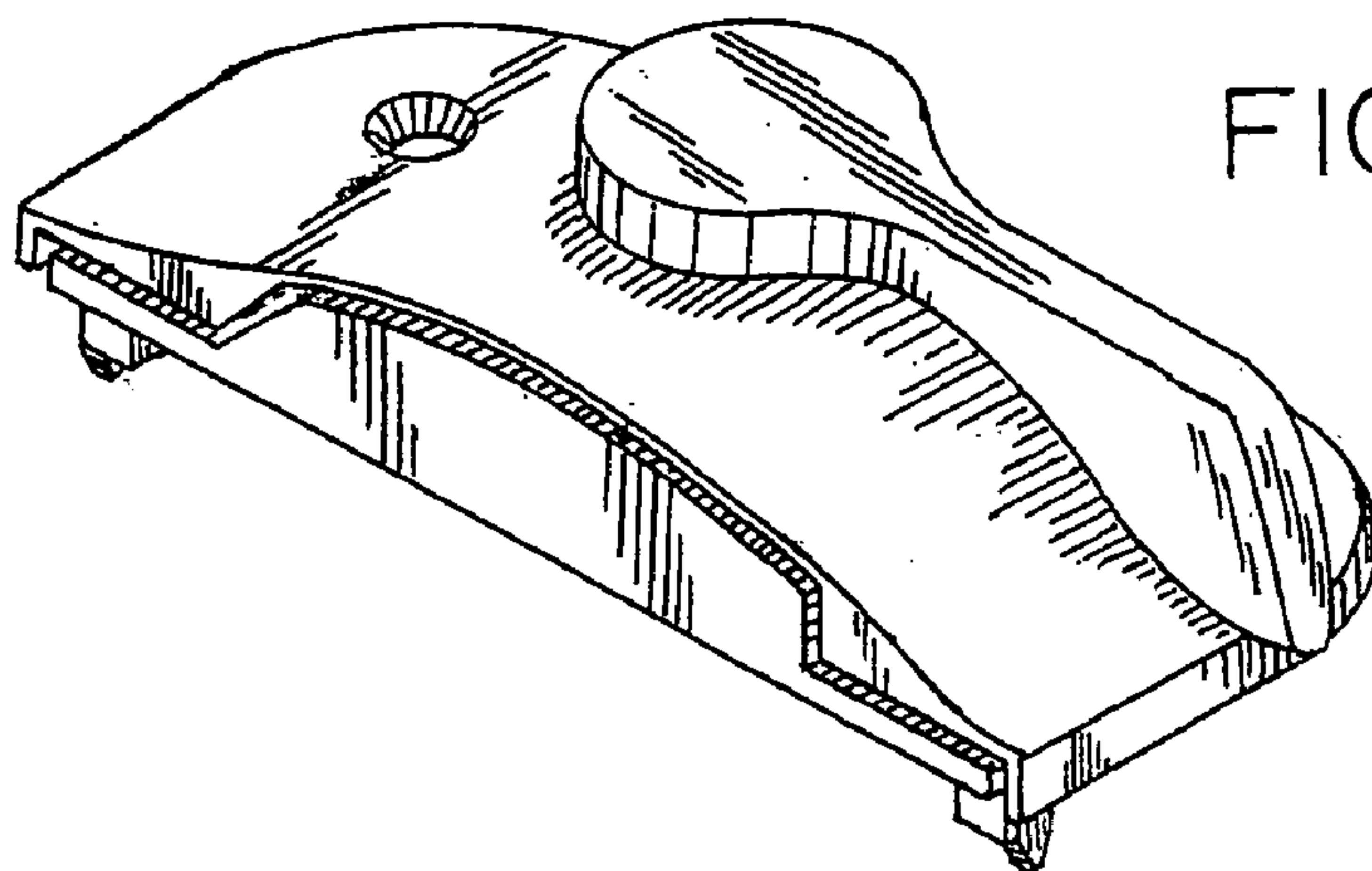

FIG. 8



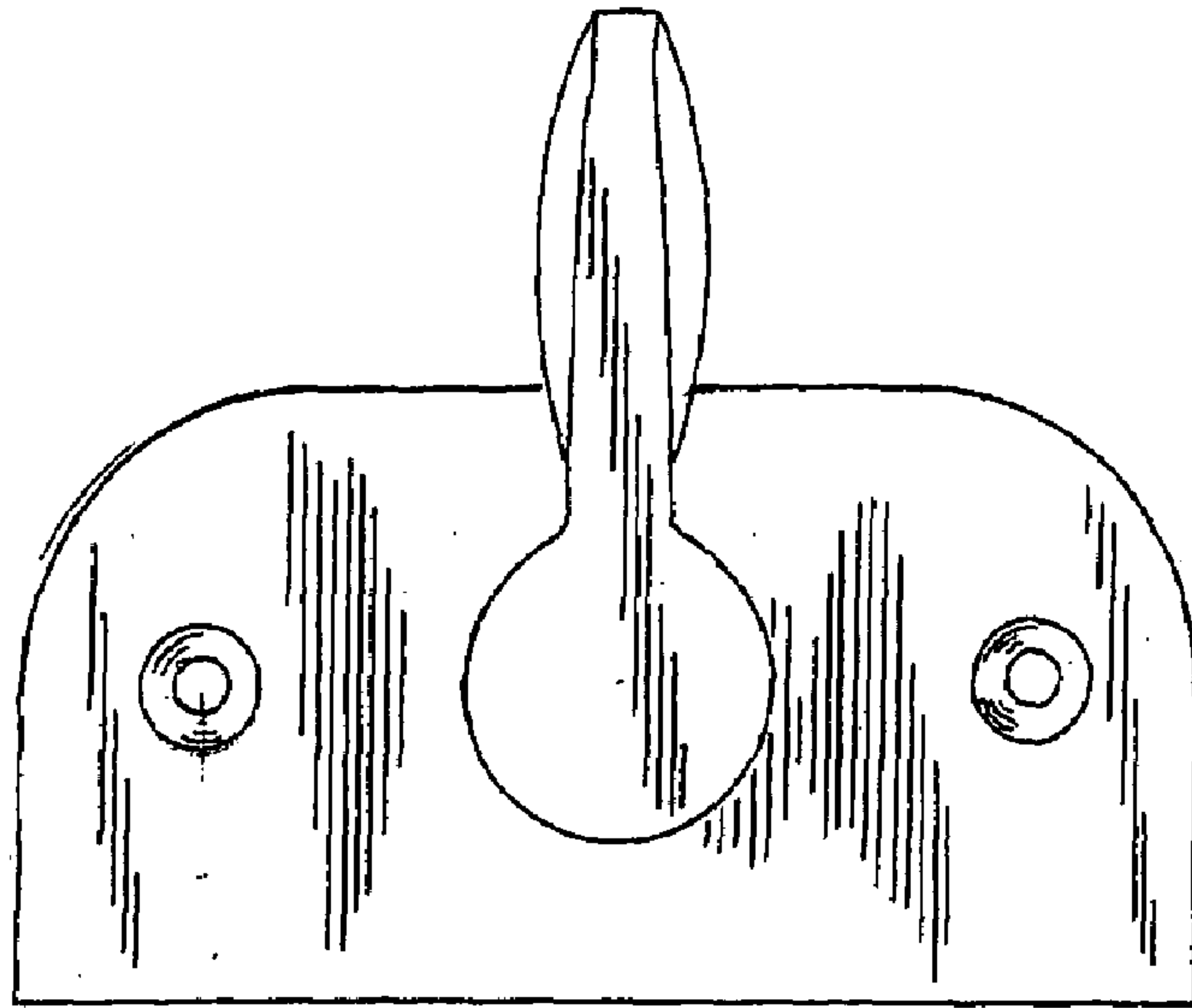

FIG. 9

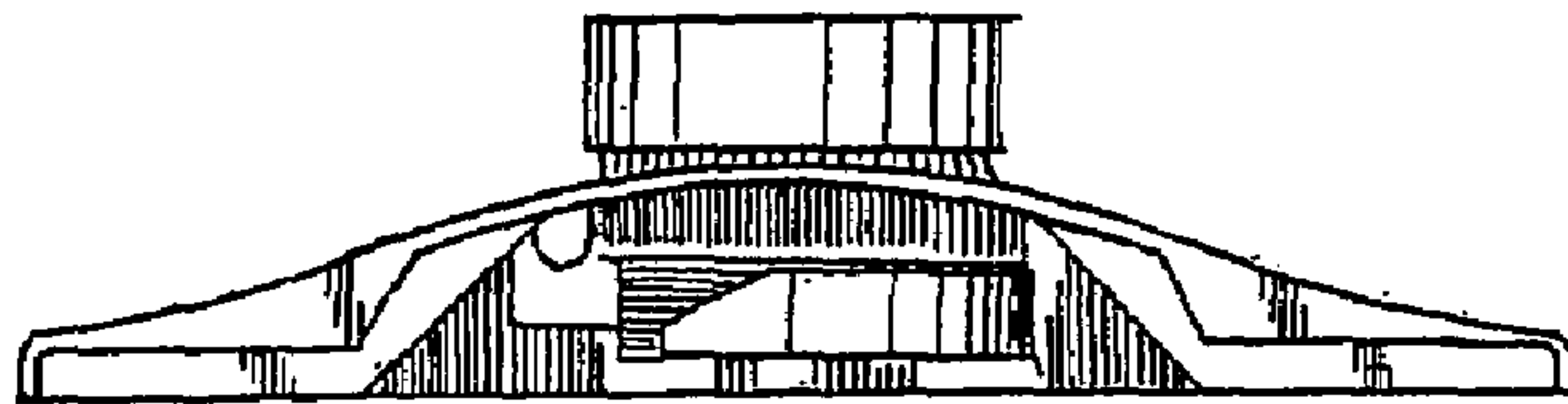

FIG. 10

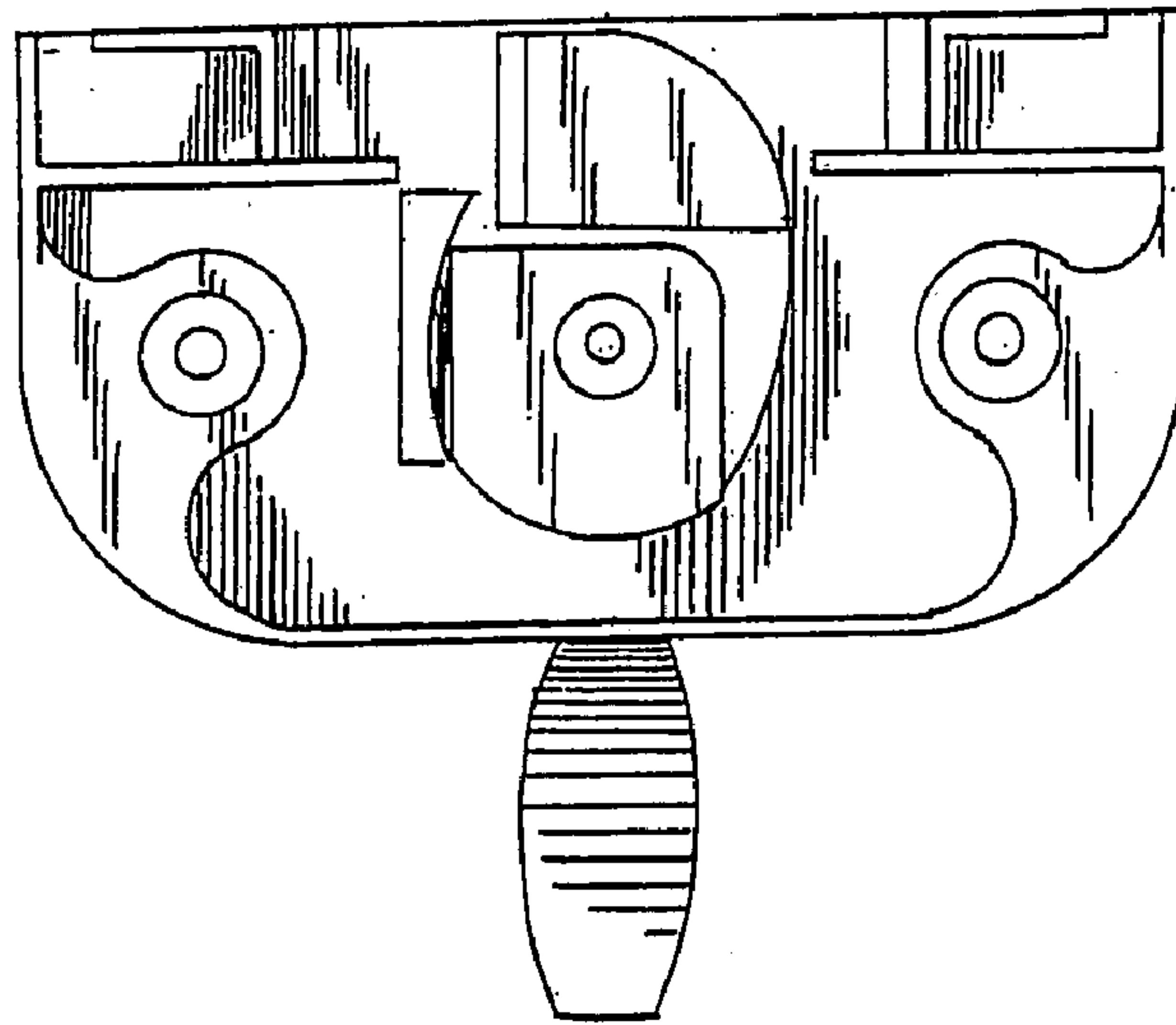

FIG. 11

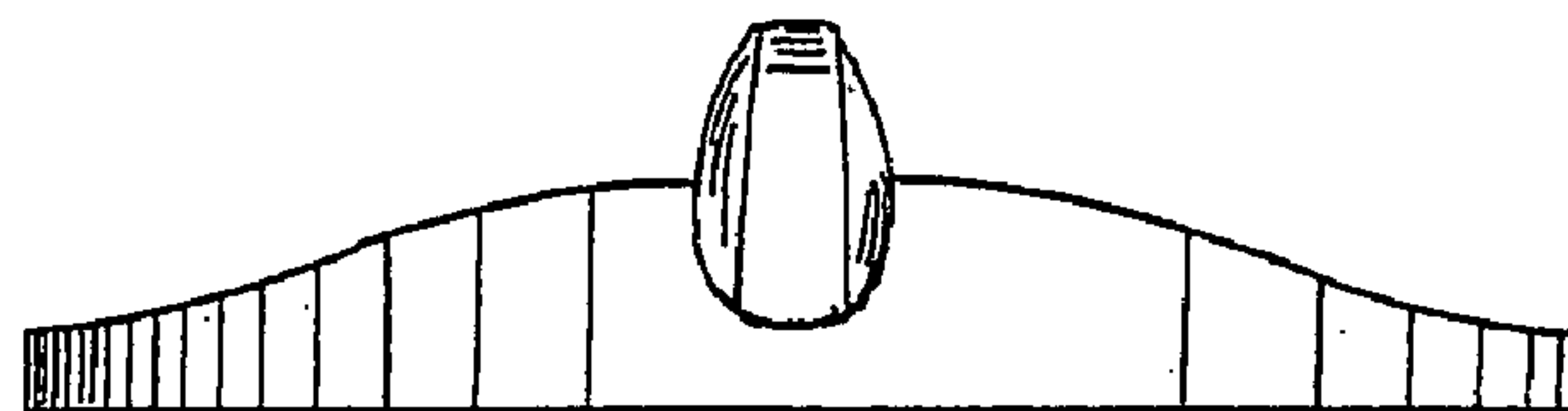

FIG. 12

FIG. 13

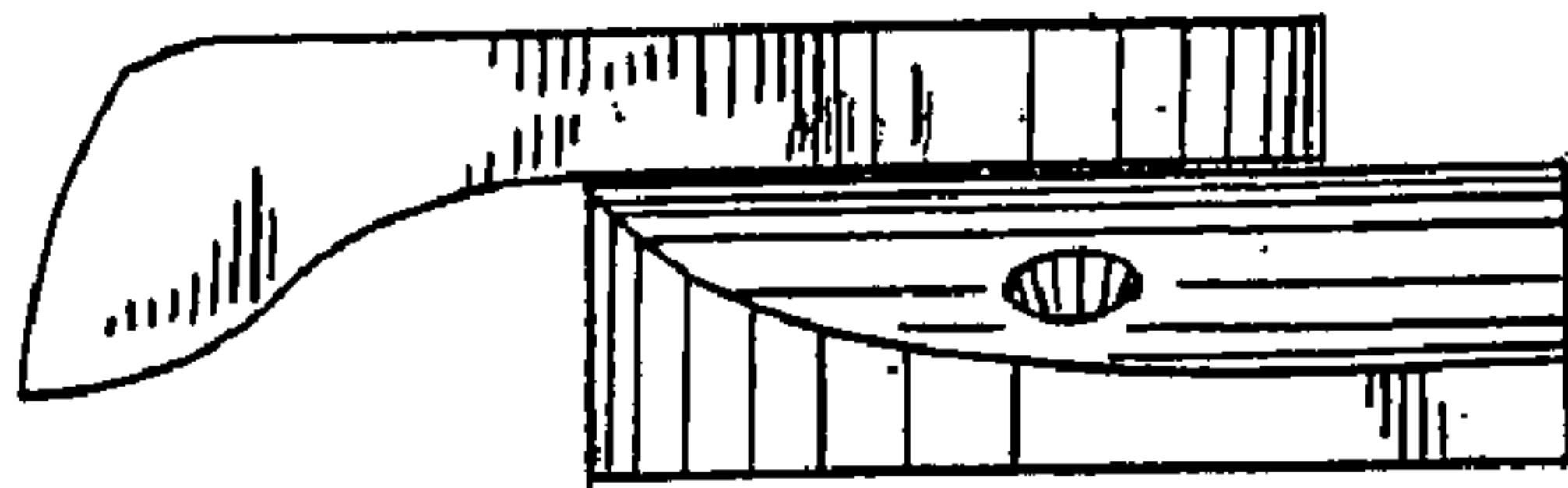

FIG. 14

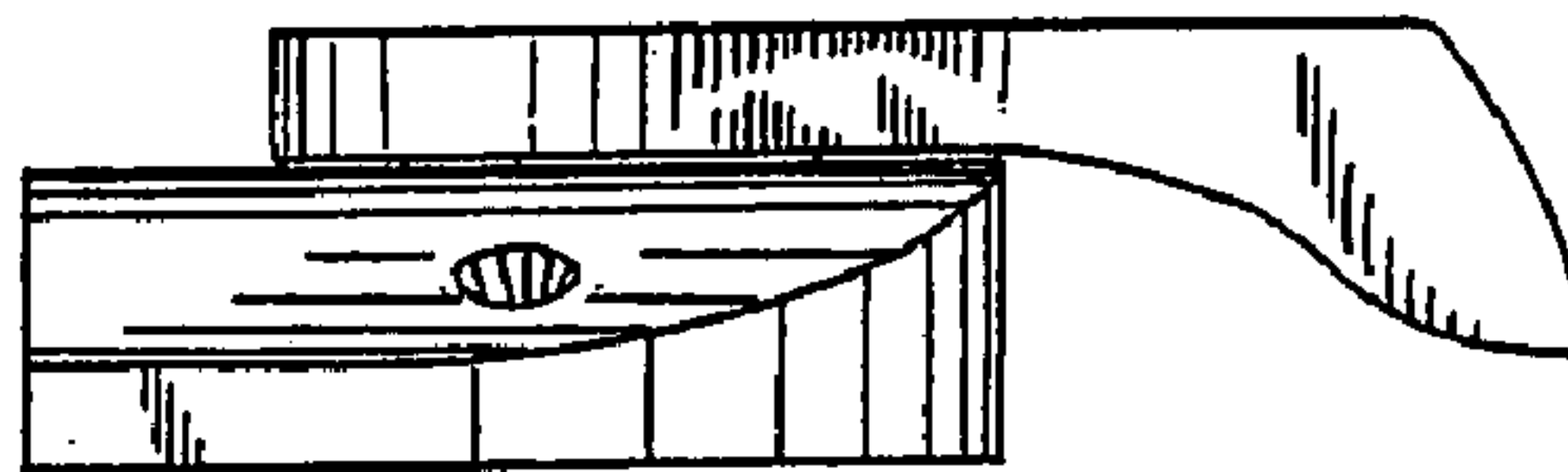

FIG. 15

