



US00D546113S

(12) **United States Design Patent**  
**Ruoff**

(10) **Patent No.:** **US D546,113 S**  
(45) **Date of Patent:** **\*\* Jul. 10, 2007**

(54) **WATER FILTRATION SYSTEM**

D459,941 S \* 7/2002 Miller ..... D7/392  
D463,706 S \* 10/2002 Lecerf ..... D7/317

(75) Inventor: **Eckhard Ruoff**, Nagold (DE)

(Continued)

(73) Assignee: **Brita GmbH**, Taunusstein (DE)

*Primary Examiner*—M. N. Pandozzi  
(74) *Attorney, Agent, or Firm*—Hudak, Shunk & Farine Co.  
LPA

(\*\*) Term: **14 Years**

(21) Appl. No.: **29/230,564**

(57) **CLAIM**

(22) Filed: **May 24, 2005**

I claim the ornamental design for a water filtration system,  
as shown.

(30) **Foreign Application Priority Data**

Nov. 25, 2004 (DE) ..... 404 06 643

**DESCRIPTION**

(51) **LOC (8) Cl.** ..... **07-01**

(52) **U.S. Cl.** ..... **D7/319; D7/317; D23/209**

(58) **Field of Classification Search** ..... D7/300,  
D7/316–319; D23/212, 209, 207; 210/282,  
210/85, 321.6; 222/465.1, 130, 189.07; 215/6;  
220/521

See application file for complete search history.

FIG. 1 is a left side front perspective view of one embodi-  
ment of a water filtration system;  
FIG. 2 is a right side rear perspective view thereof;  
FIG. 3 is a left side view thereof;  
FIG. 4 is a right side view thereof;  
FIG. 5 is a front elevated view thereof;  
FIG. 6 is a rear elevated view thereof;  
FIG. 7 is a top plan view thereof;  
FIG. 8 is a bottom plan view thereof;  
FIG. 9 is a left front perspective view of a further embodi-  
ment of a water filtration system;  
FIG. 10 is a right side rear perspective view thereof;  
FIG. 11 is a left side view thereof;  
FIG. 12 is a right side view thereof;  
FIG. 13 is a front elevated view thereof;  
FIG. 14 is a rear elevated view thereof;  
FIG. 15 is a top plan view thereof; and,  
FIG. 16 is a bottom plan view thereof.

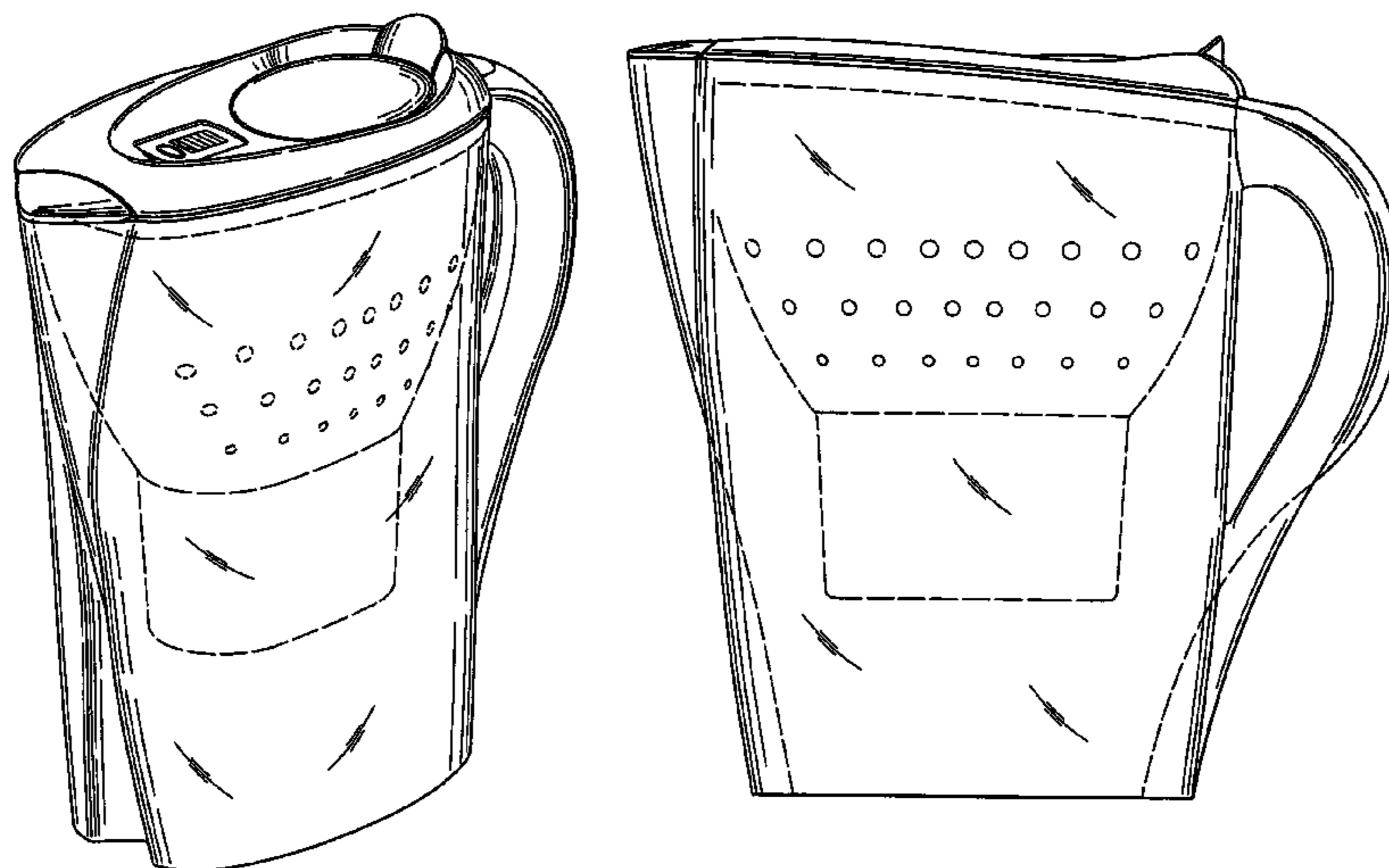
(56) **References Cited**

**U.S. PATENT DOCUMENTS**

- 5,637,214 A \* 6/1997 Kahana ..... 210/282
- D383,351 S \* 9/1997 DeMore ..... D7/319
- 5,663,224 A \* 9/1997 Emmons et al. .... 524/188
- D388,654 S \* 1/1998 Bouhuys ..... D7/319
- D389,004 S \* 1/1998 Hampshire et al. .... D7/319
- D389,006 S \* 1/1998 Demore et al. .... D7/319
- D398,184 S \* 9/1998 Silverberg et al. .... D7/319
- D415,922 S \* 11/1999 Kawasaki et al. .... D7/317
- D416,163 S \* 11/1999 Doritty et al. .... D7/319
- D421,361 S \* 3/2000 Coulson et al. .... D7/319
- 6,103,114 A \* 8/2000 Tanner et al. .... 210/232
- D437,175 S \* 2/2001 Brady ..... D7/319
- D439,790 S \* 4/2001 Matsushita et al. .... D7/319
- D440,110 S \* 4/2001 Tanner et al. .... D7/319
- 6,224,751 B1 \* 5/2001 Hofmann et al. .... 210/85
- D444,662 S \* 7/2001 McGrath et al. .... D7/319
- D444,843 S \* 7/2001 Hilgers et al. .... D23/207
- D444,987 S \* 7/2001 McGrath et al. .... D7/319

The broken lines in the drawings are for illustrative purposes  
only and form no part of the claimed design.

**1 Claim, 13 Drawing Sheets**



# US D546,113 S

Page 2

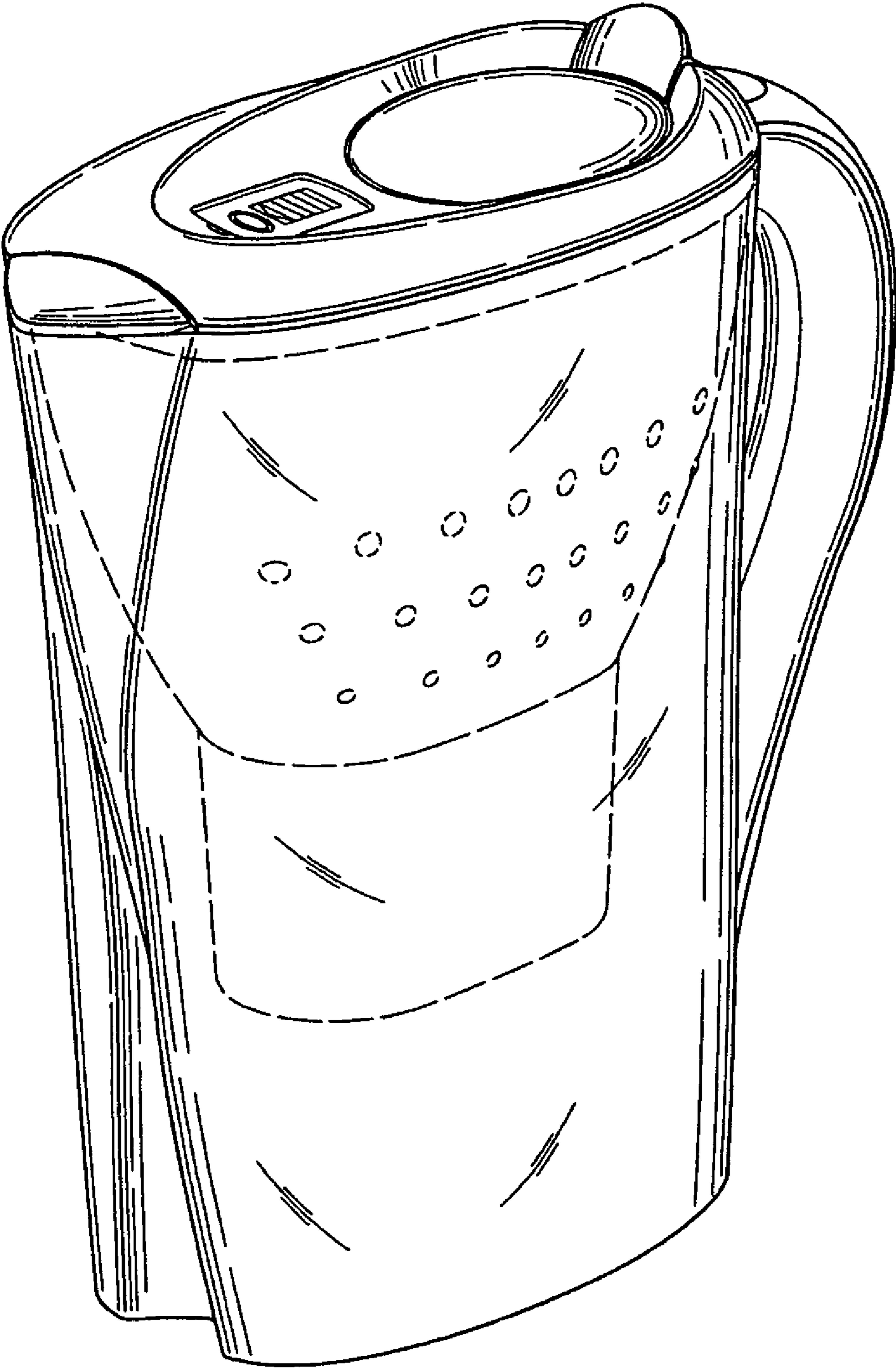
---

## U.S. PATENT DOCUMENTS

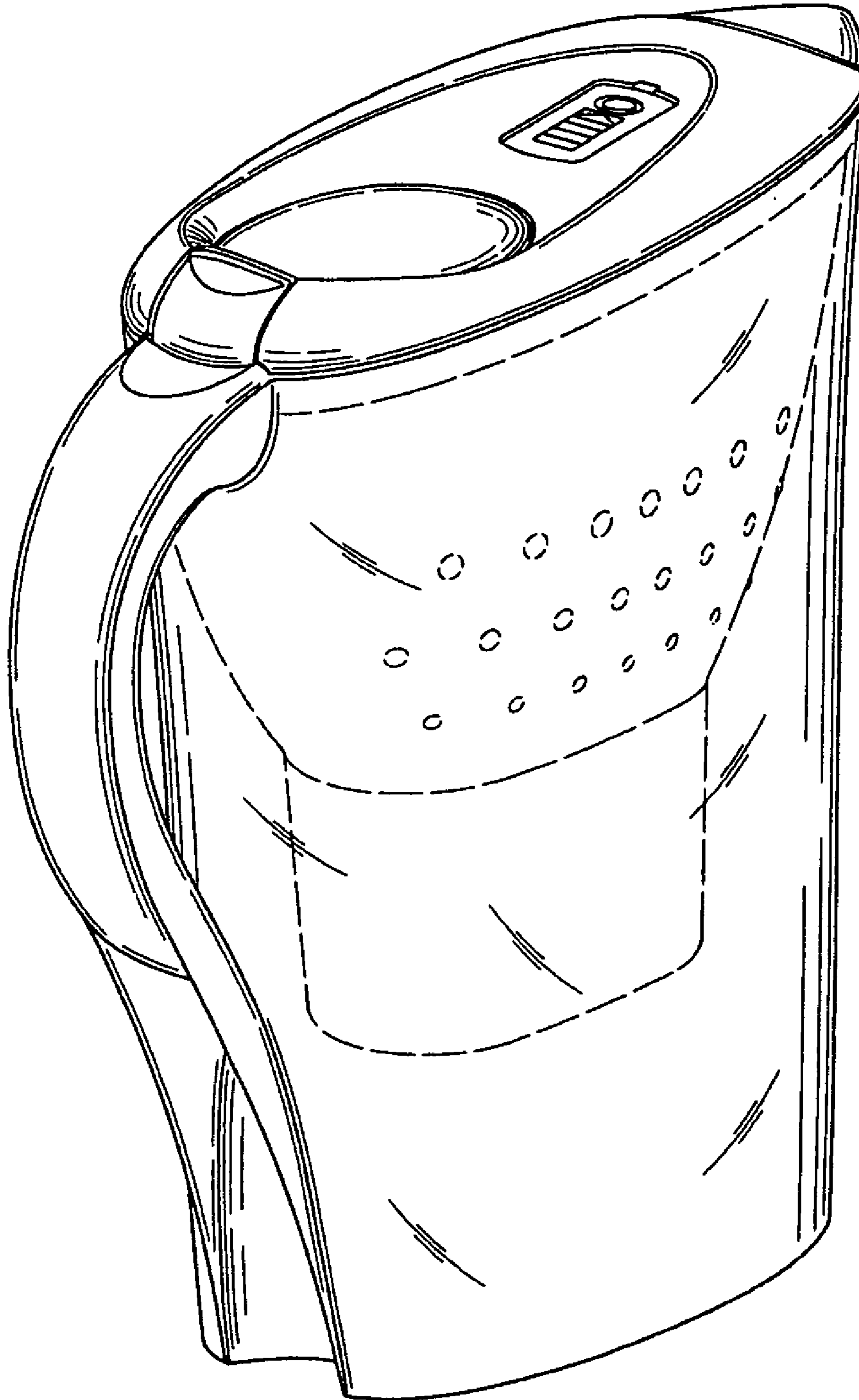
D505,593 S *	5/2005	Chen .....	D7/536	D527,940 S *	9/2006	Cohen .....	D7/318
6,953,523 B2 *	10/2005	Vandenbelt et al. ....	210/85	7,107,838 B2 *	9/2006	Chai et al. ....	73/304 R
D520,597 S *	5/2006	Witte .....	D23/209	2004/0168957 A1 *	9/2004	Tsataros et al. ....	210/85

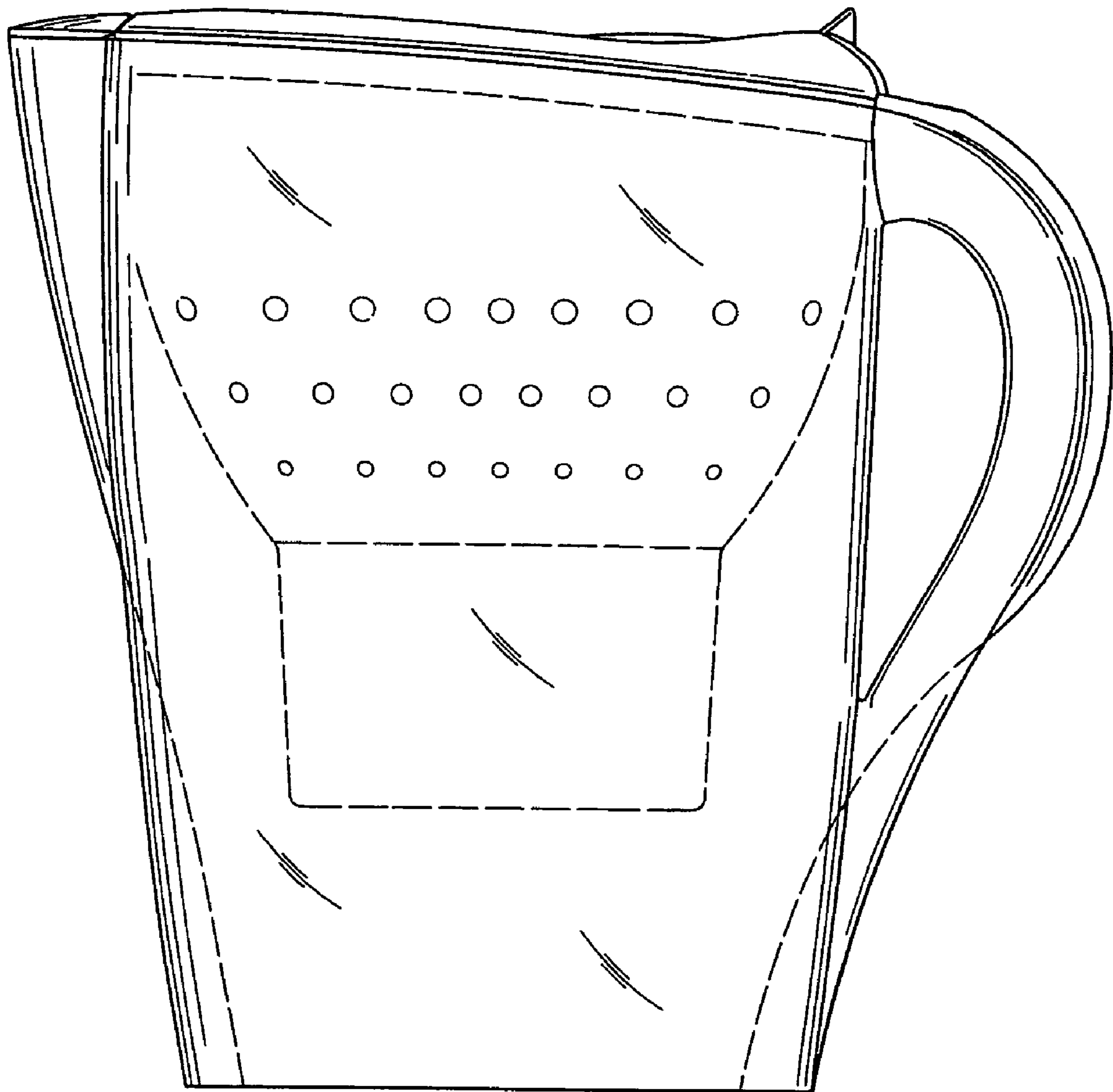
\* cited by examiner

***Fig. 1***

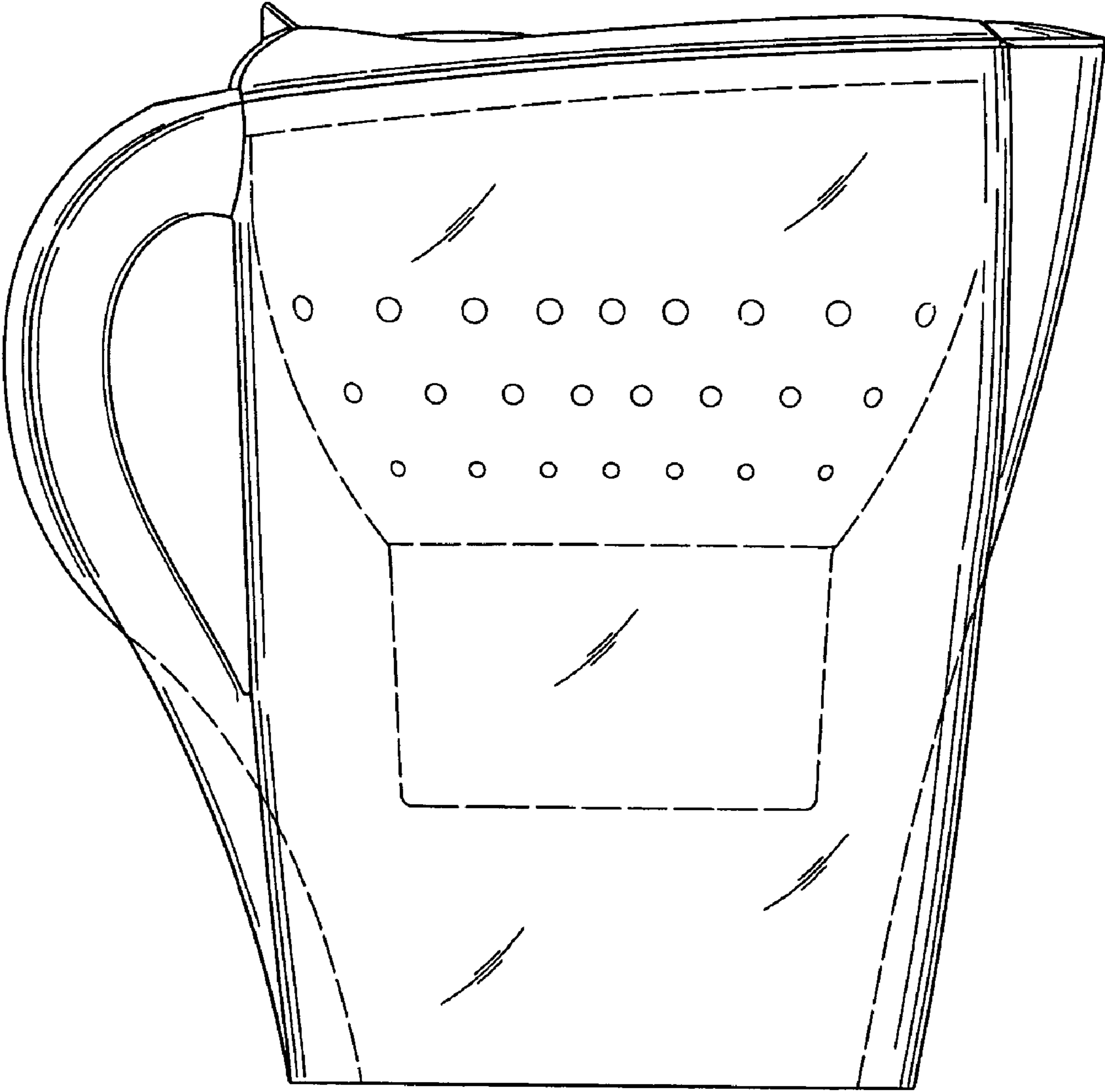


***Fig. 2***

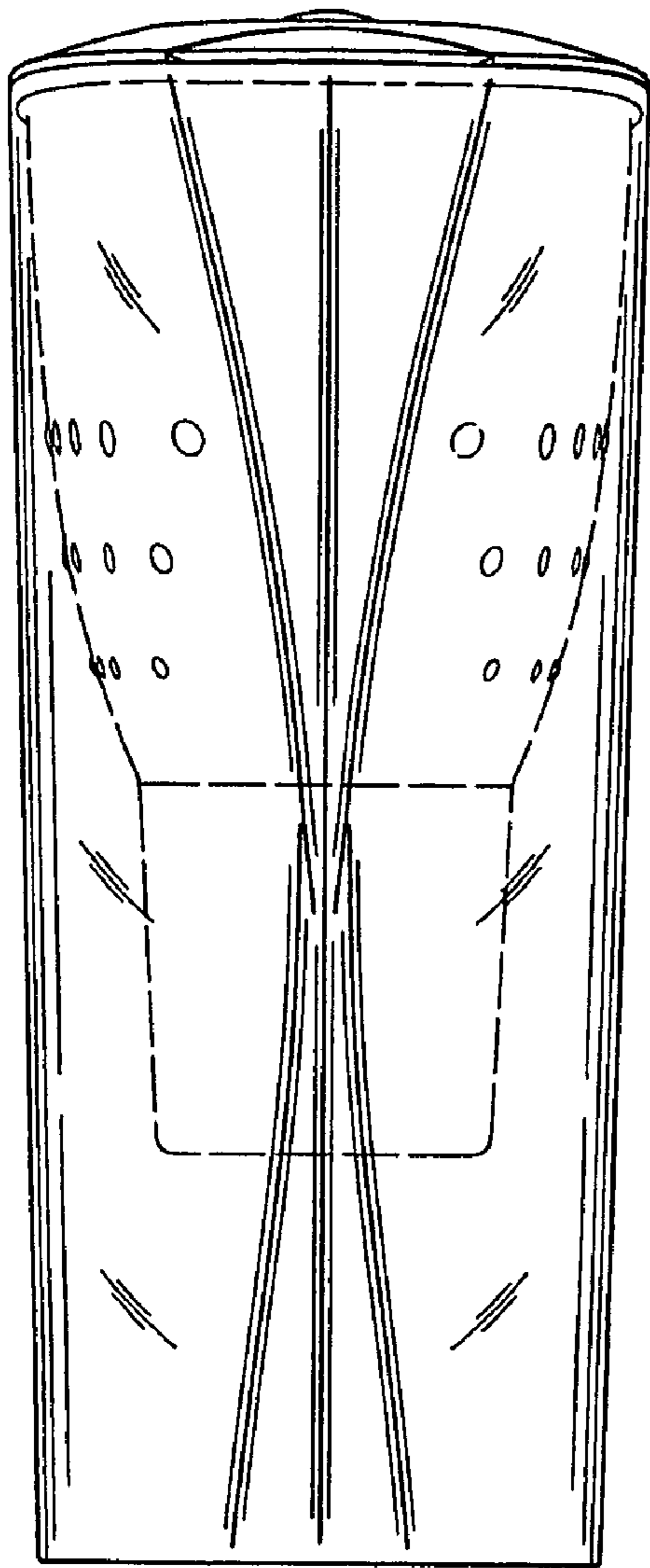




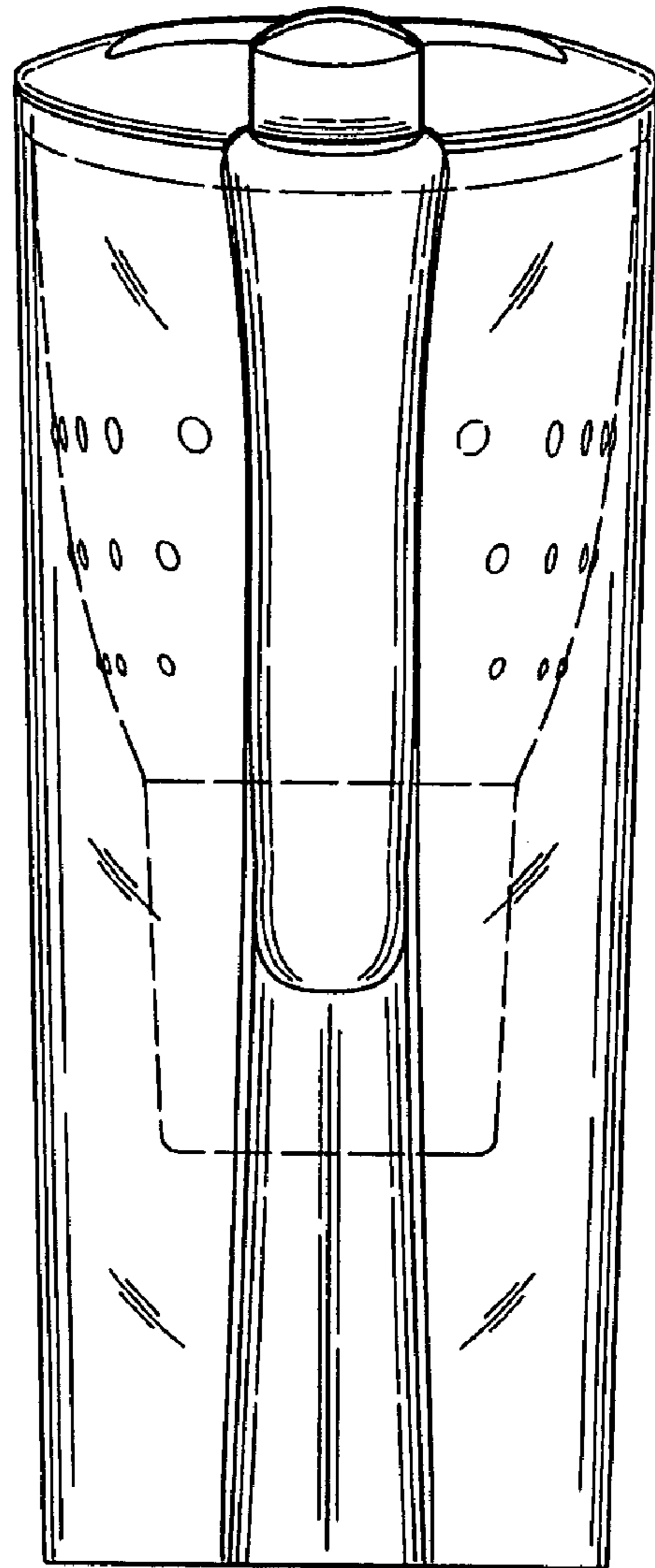
***Fig. 3***



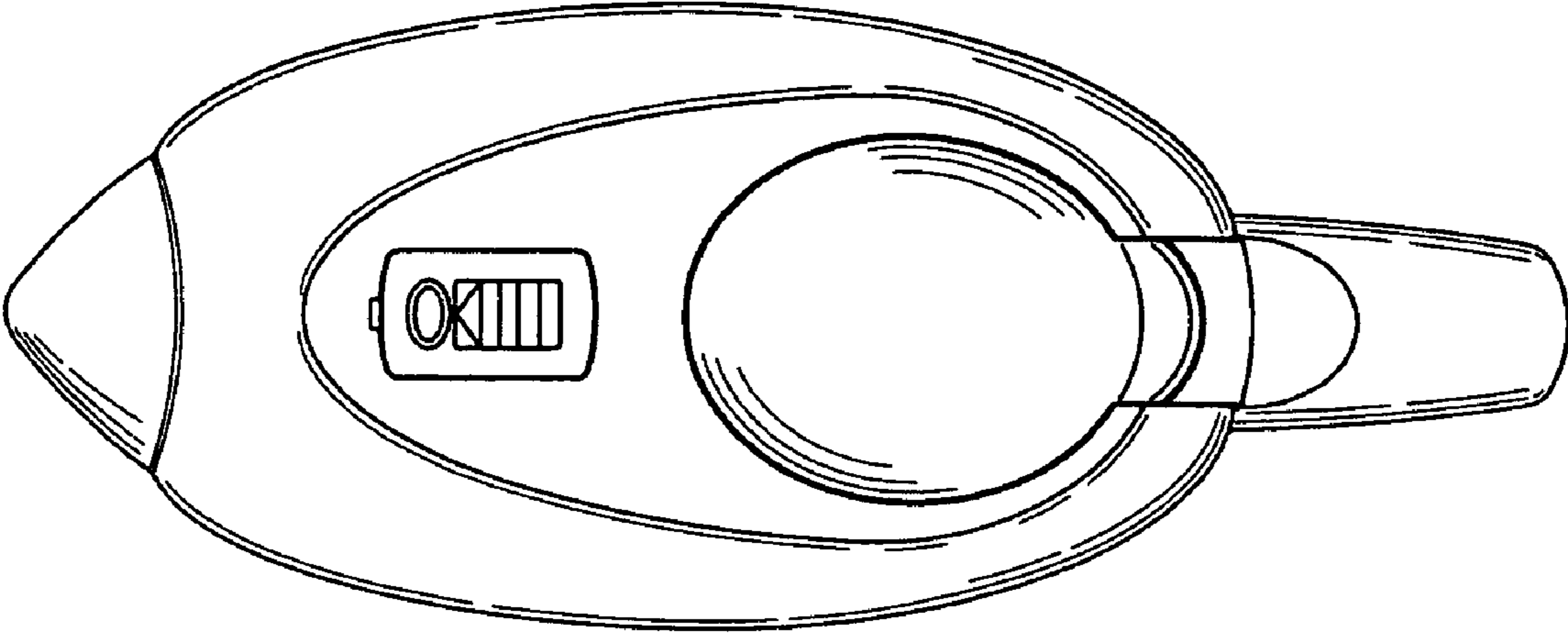
***Fig. 4***



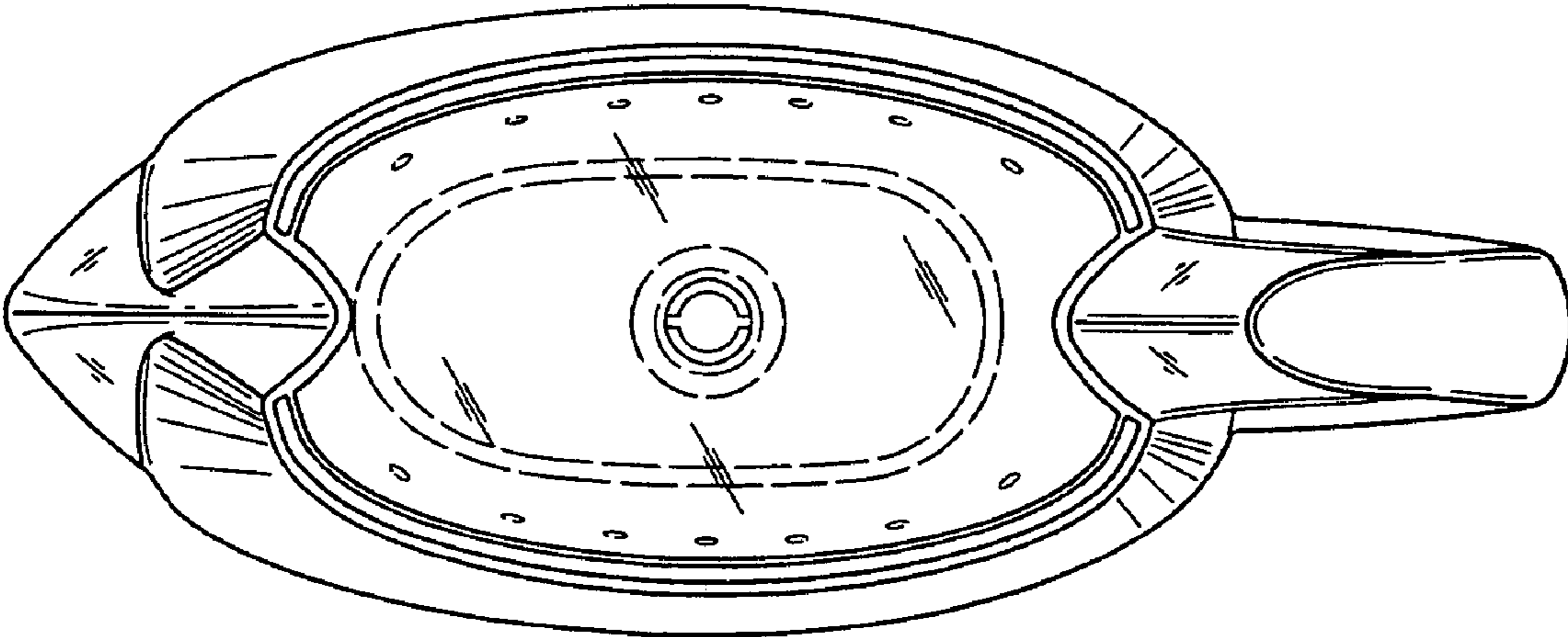
***Fig. 5***



***Fig. 6***



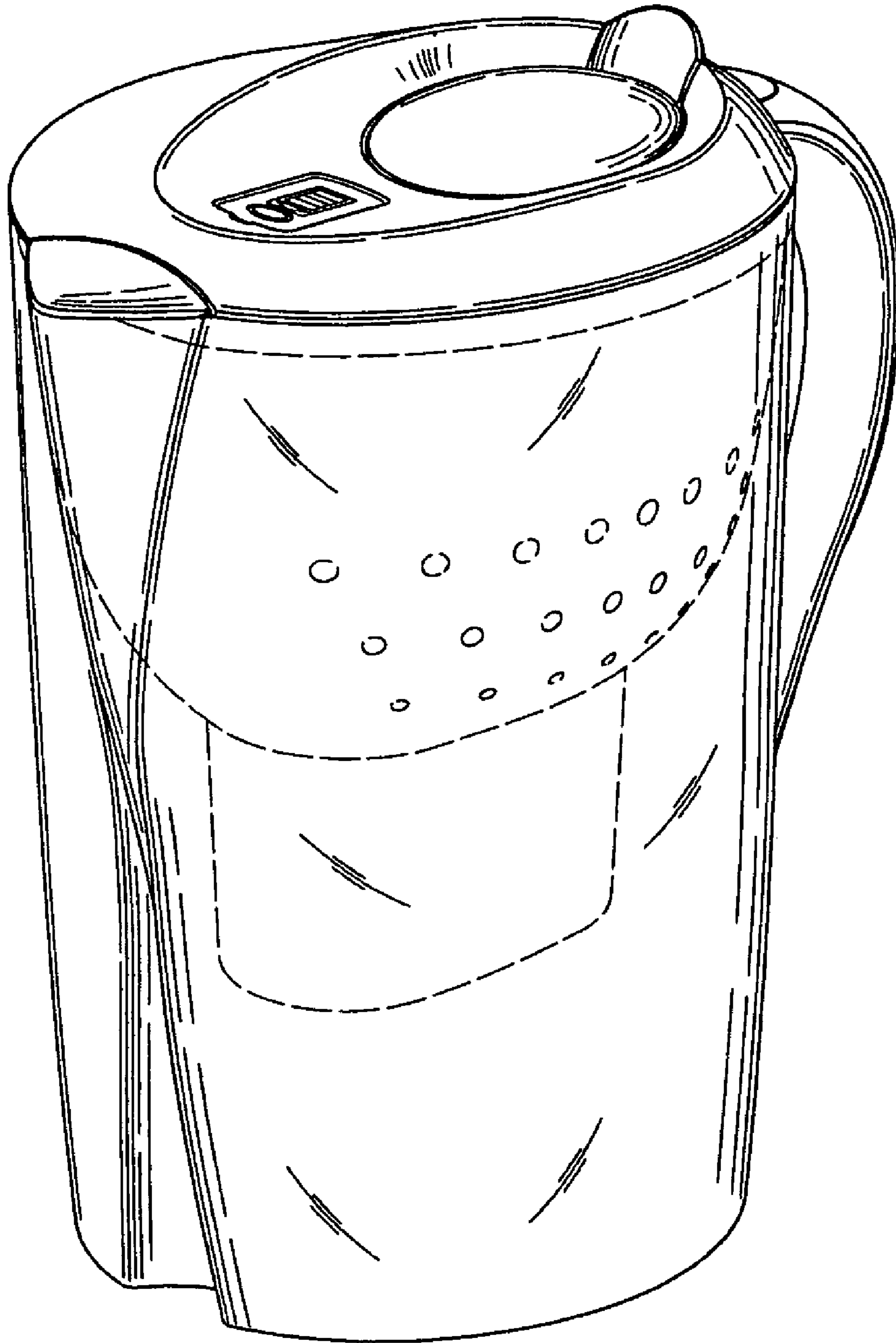
**Fig. 7**



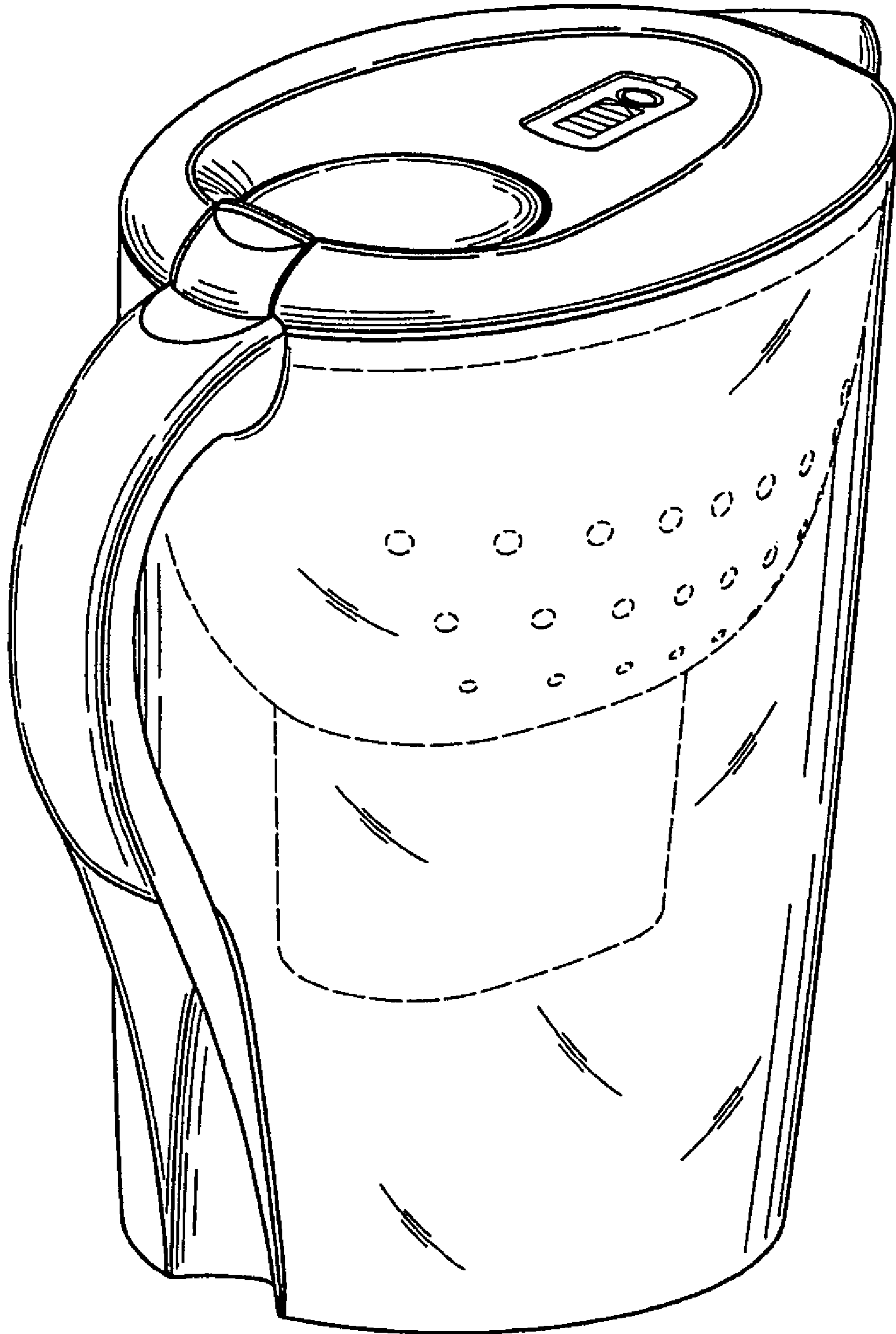
**Fig. 8**

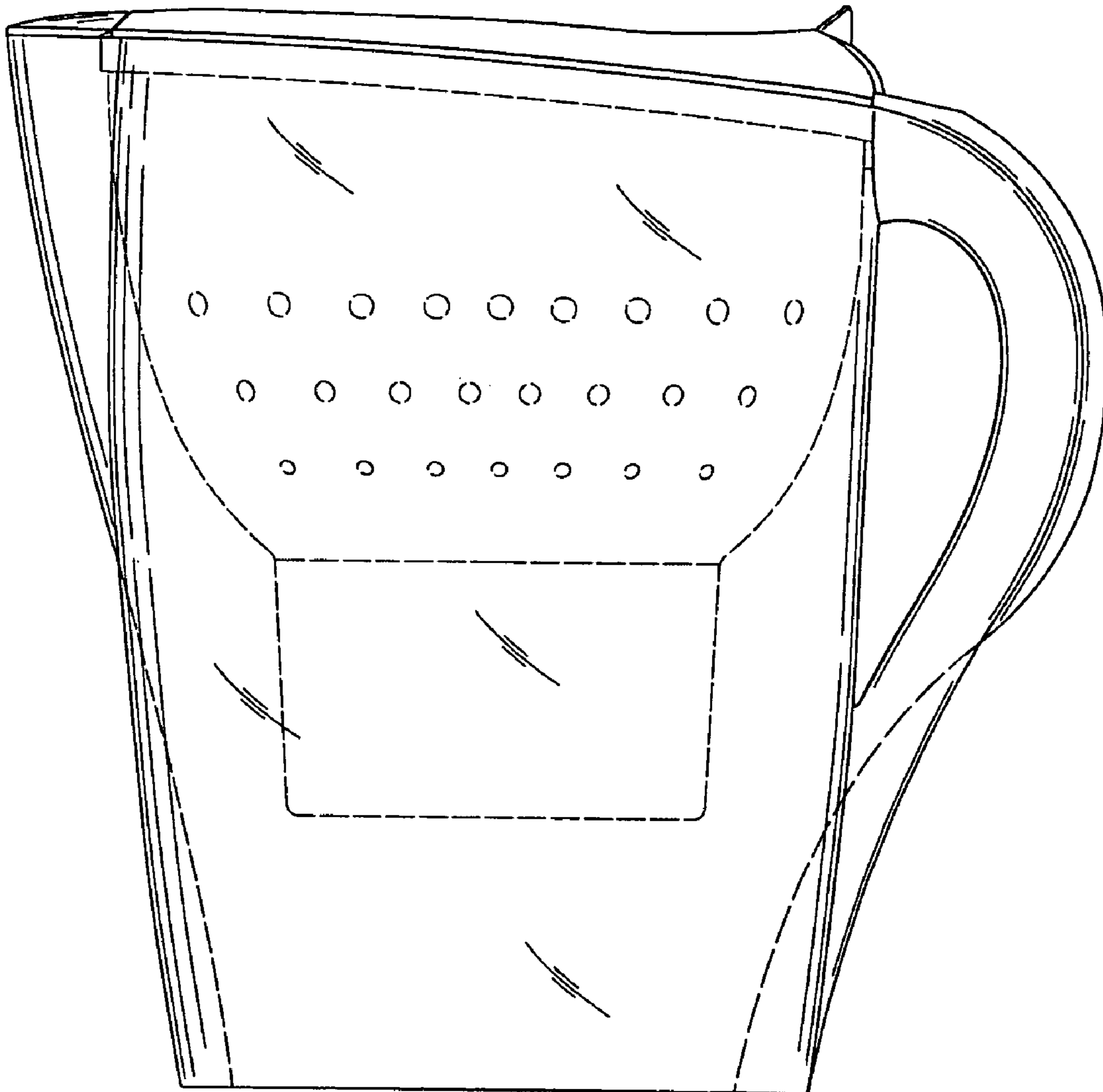


***Fig. 9***

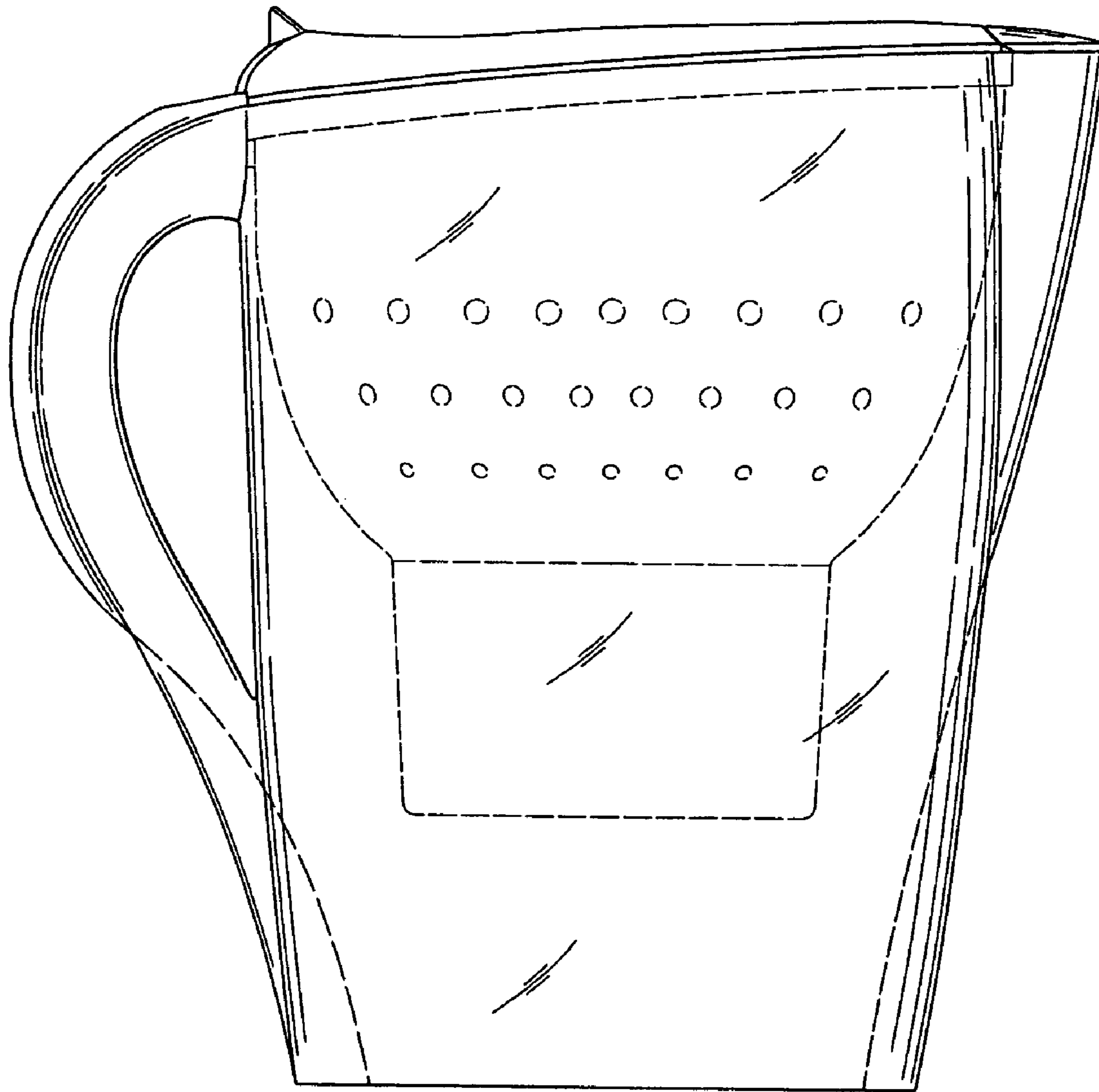


***Fig. 10***

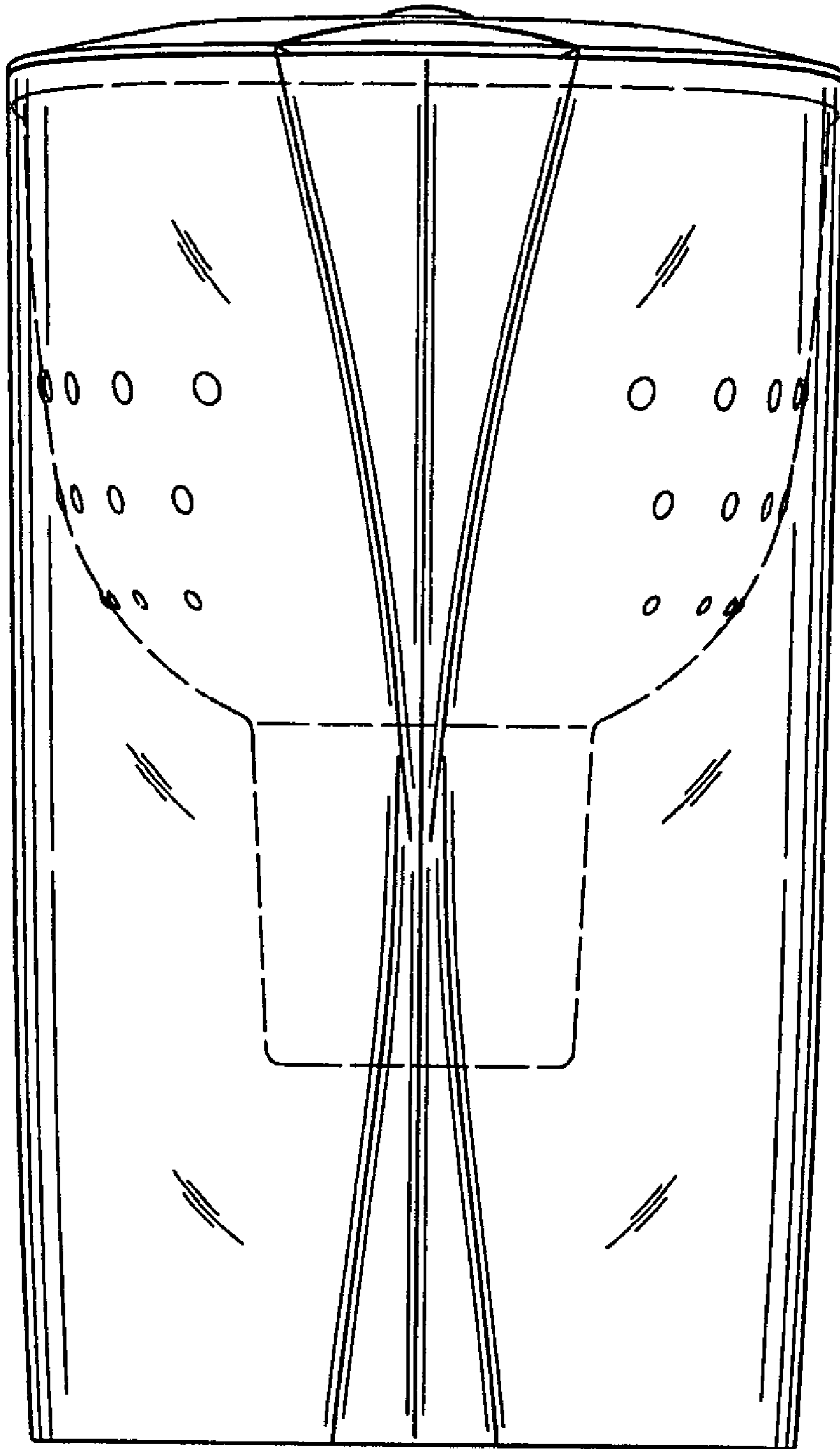




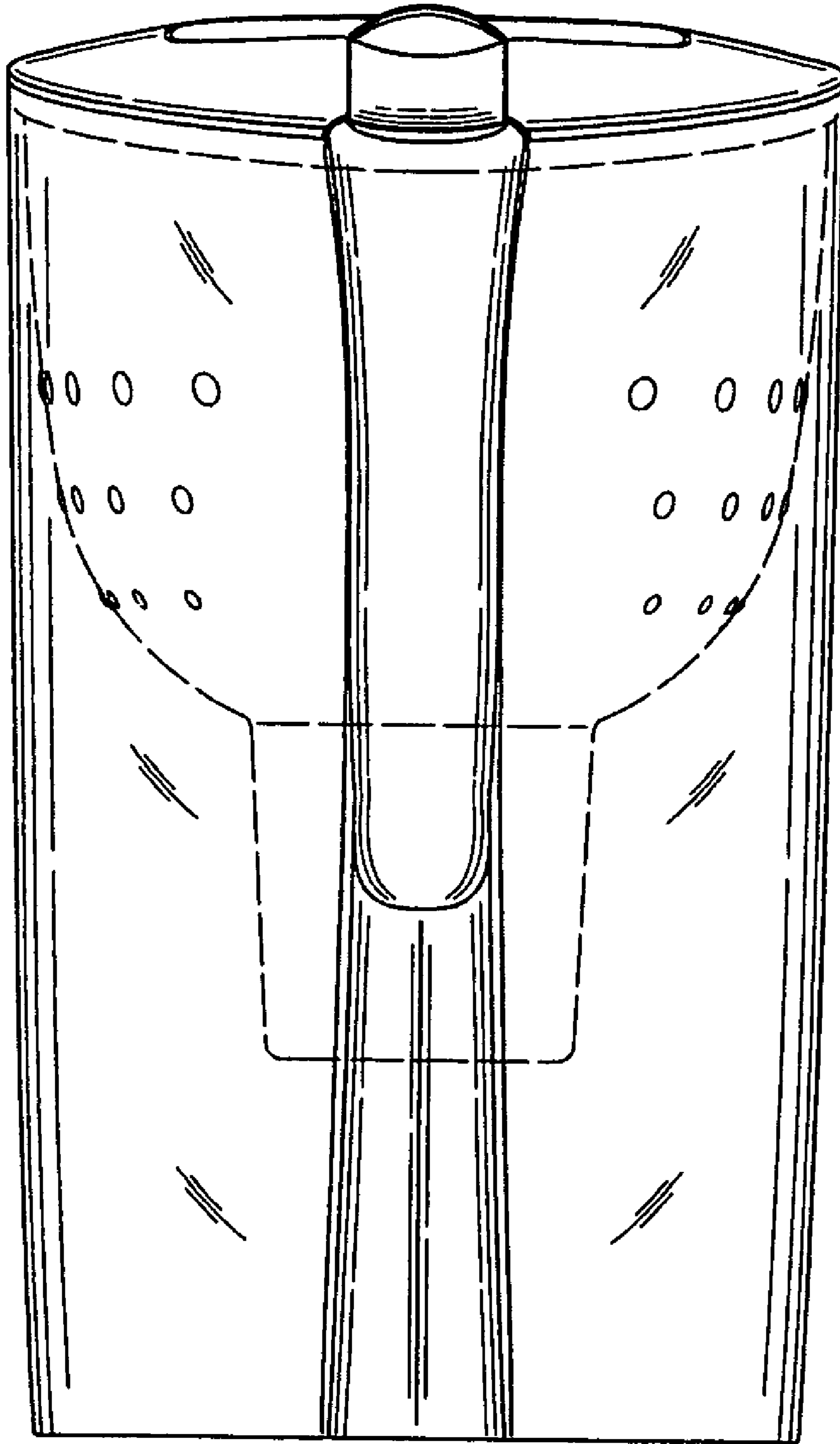
***Fig. 11***



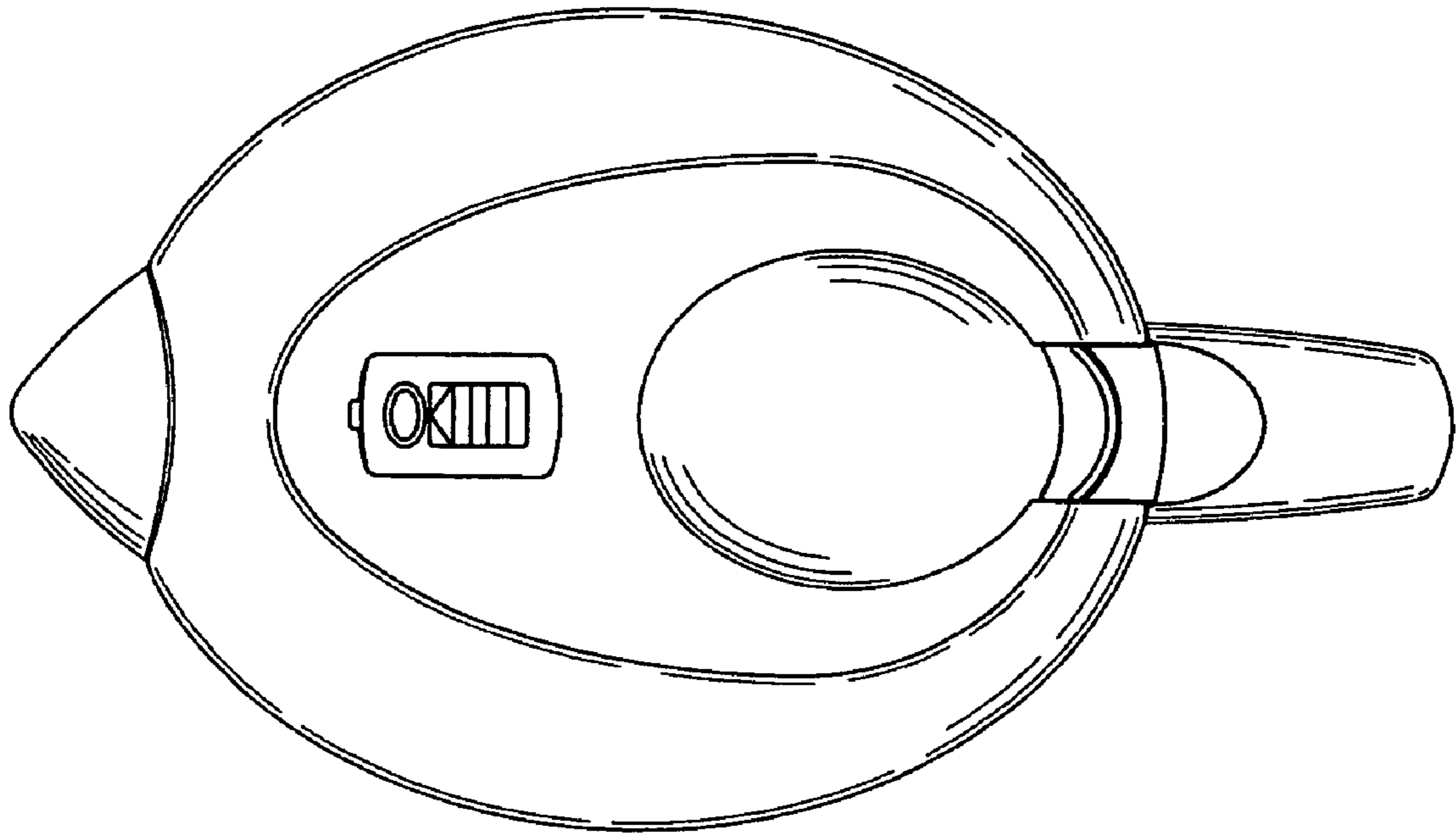
***Fig. 12***



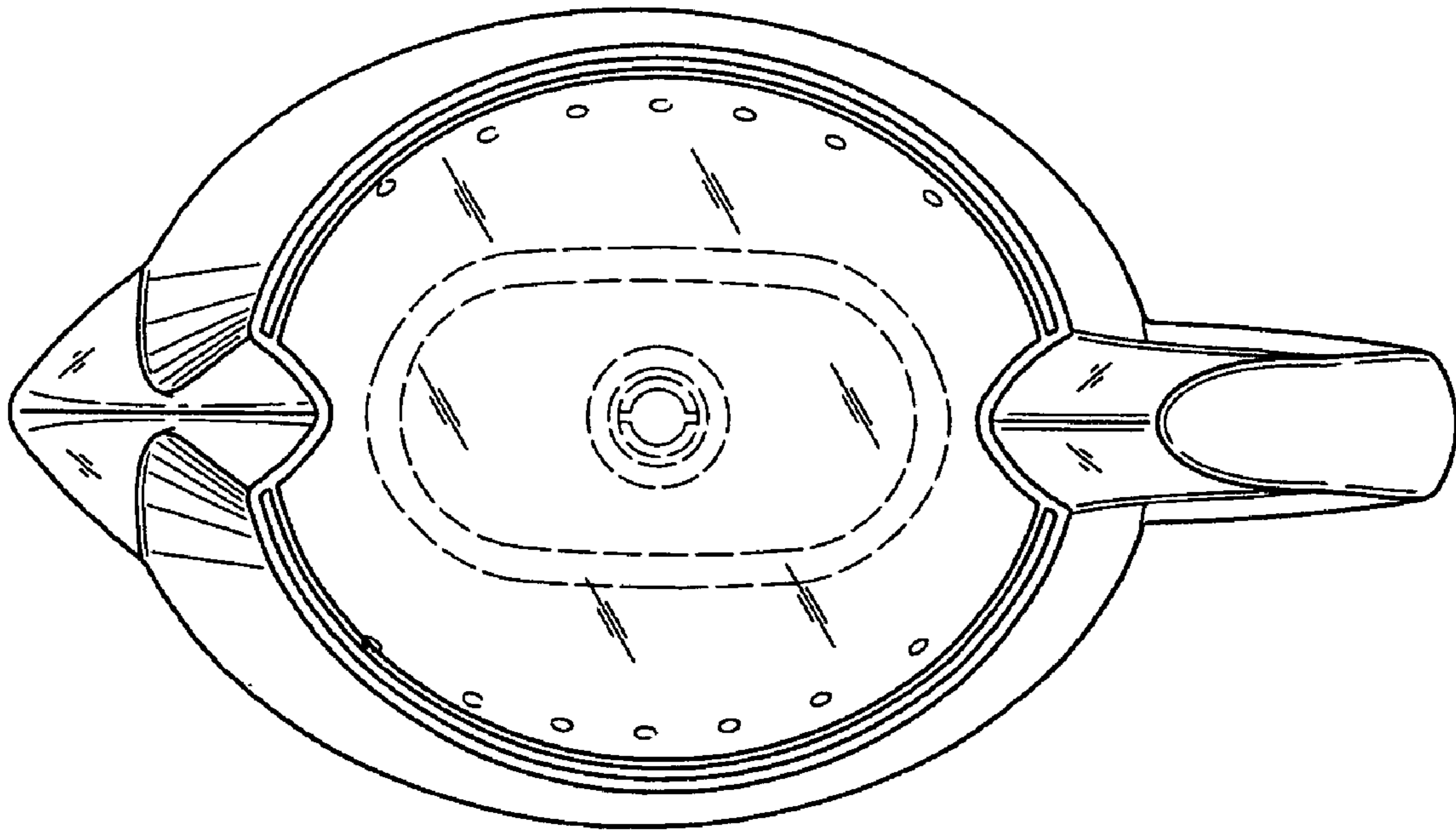
***Fig. 13***



**Fig. 14**



***Fig. 15***



***Fig. 16***