

US00D546056S

(12) **United States Design Patent**  
**Oas**

(10) **Patent No.:** **US D546,056 S**

(45) **Date of Patent:** **\*\* Jul. 10, 2007**

(54) **PILL POD**

D525,151 S \* 7/2006 Oas ..... D3/203.2

\* cited by examiner

(76) Inventor: **Daniel Oas**, 6250 N. Irwindale Ave.,  
Irwindale, CA (US) 91702

*Primary Examiner*—Catherine R. Oliver

(\*\*) Term: **14 Years**

(74) *Attorney, Agent, or Firm*—Edgar W. Averill, Jr.;  
Kenneth L. Green

(21) Appl. No.: **29/268,281**

(57) **CLAIM**

(22) Filed: **Nov. 2, 2006**

The ornamental design for a pill pod, as shown and described.

(51) **LOC (8) Cl.** ..... **03-01**

(52) **U.S. Cl.** ..... **D3/203.2**

(58) **Field of Classification Search** ..... D3/203.2,  
D3/203.1, 203.3, 203.4, 203.5, 203.7, 203.8,  
D3/201, 205, 207–212; 206/530, 534, 528  
See application file for complete search history.

**DESCRIPTION**

FIG. 1 is a perspective view showing the front, top and right side of the pill pod showing my new design.

FIG. 2 is a front view thereof.

FIG. 3 is a top view thereof.

FIG. 4 is a bottom view thereof.

FIG. 5 is a right side view thereof.

FIG. 6 is a rear view thereof; and,

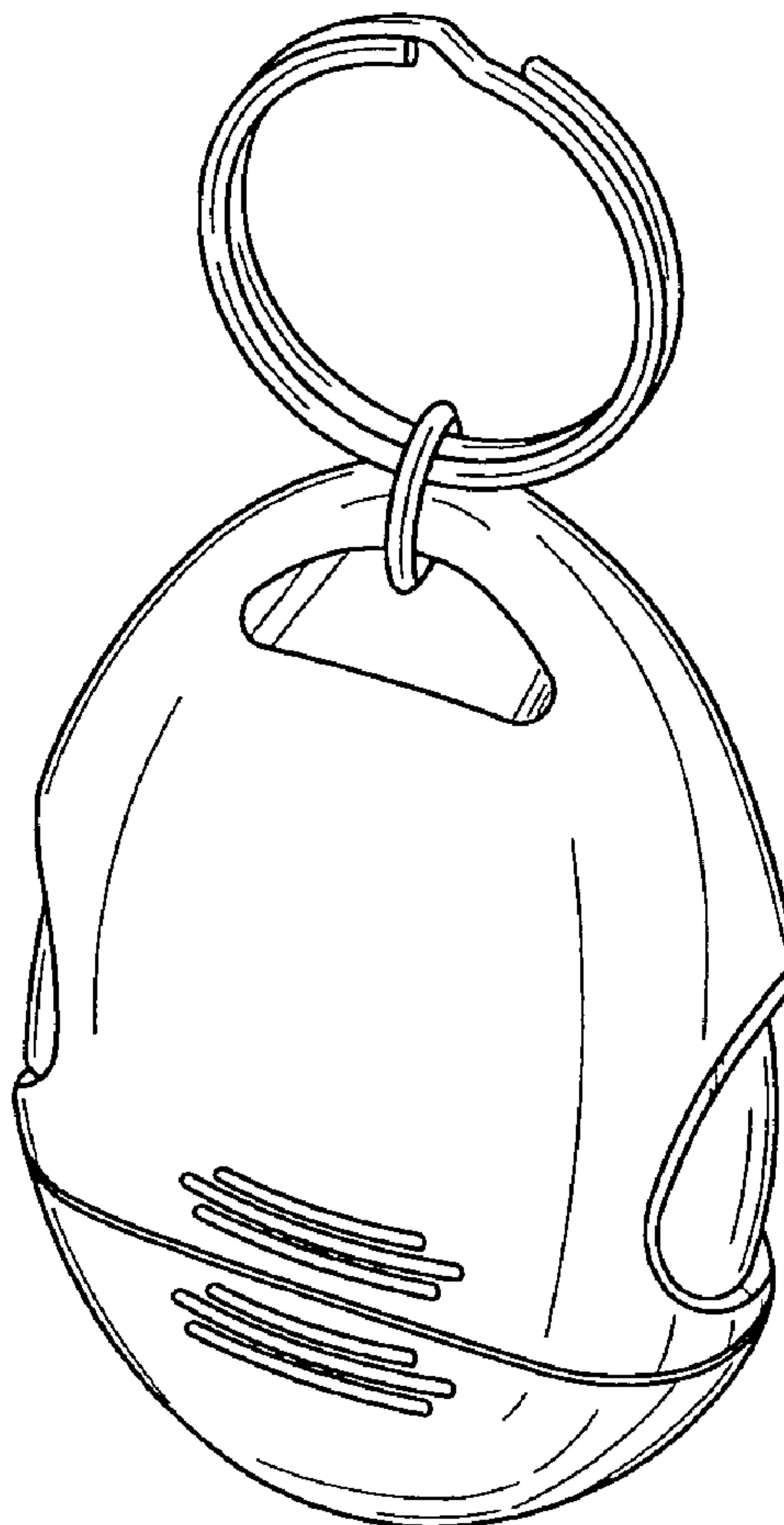
FIG. 7 is an exploded perspective view thereof in a disassembled configuration.

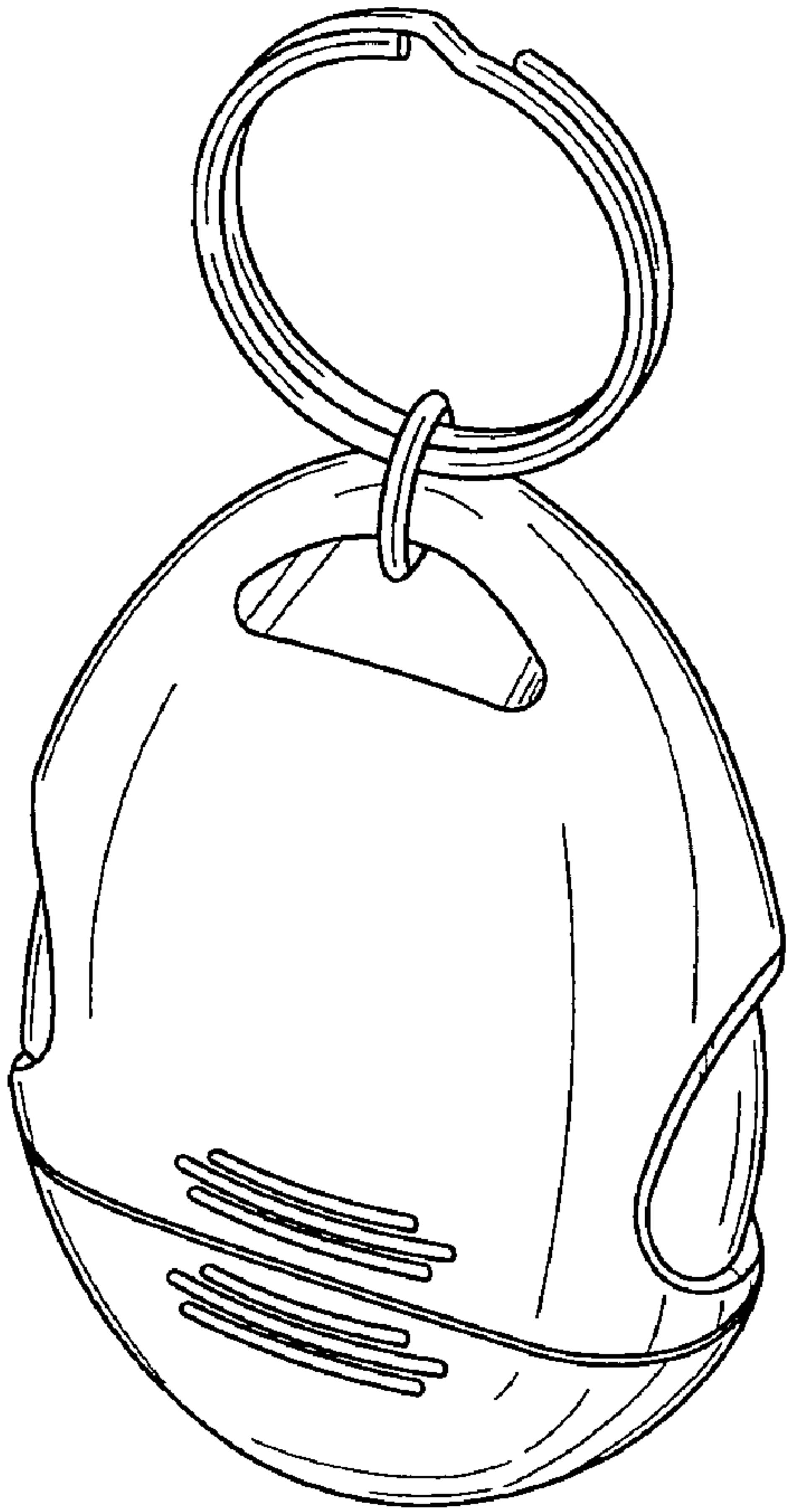
(56) **References Cited**

**U.S. PATENT DOCUMENTS**

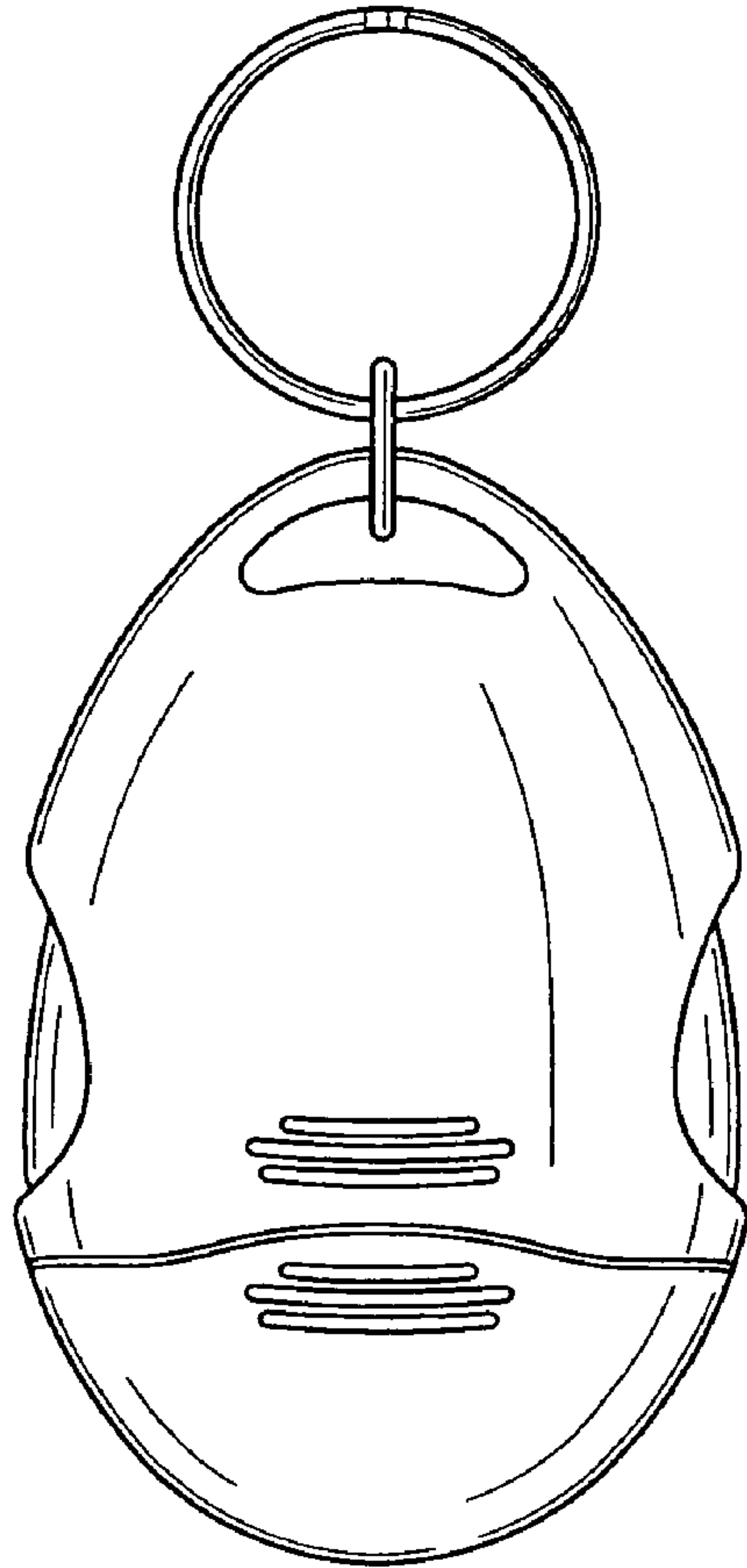
- D349,644 S \* 8/1994 Miyairi et al. .... D3/203.2
- D471,801 S \* 3/2003 Caroen ..... D3/203.2
- D483,560 S \* 12/2003 Thompson ..... D3/203.2
- D497,246 S \* 10/2004 Darst ..... D3/203.2
- D517,799 S \* 3/2006 Oas ..... D3/203.2

**1 Claim, 2 Drawing Sheets**

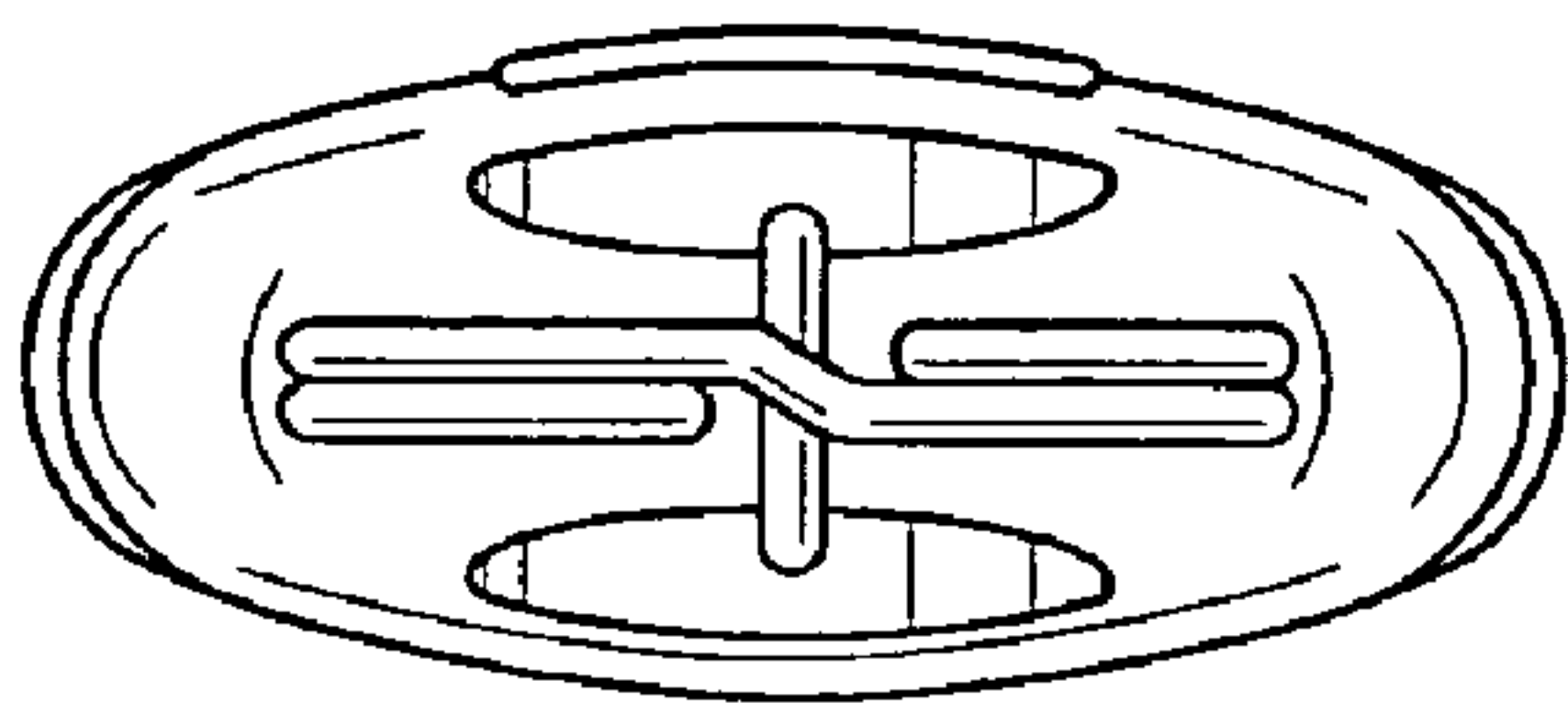




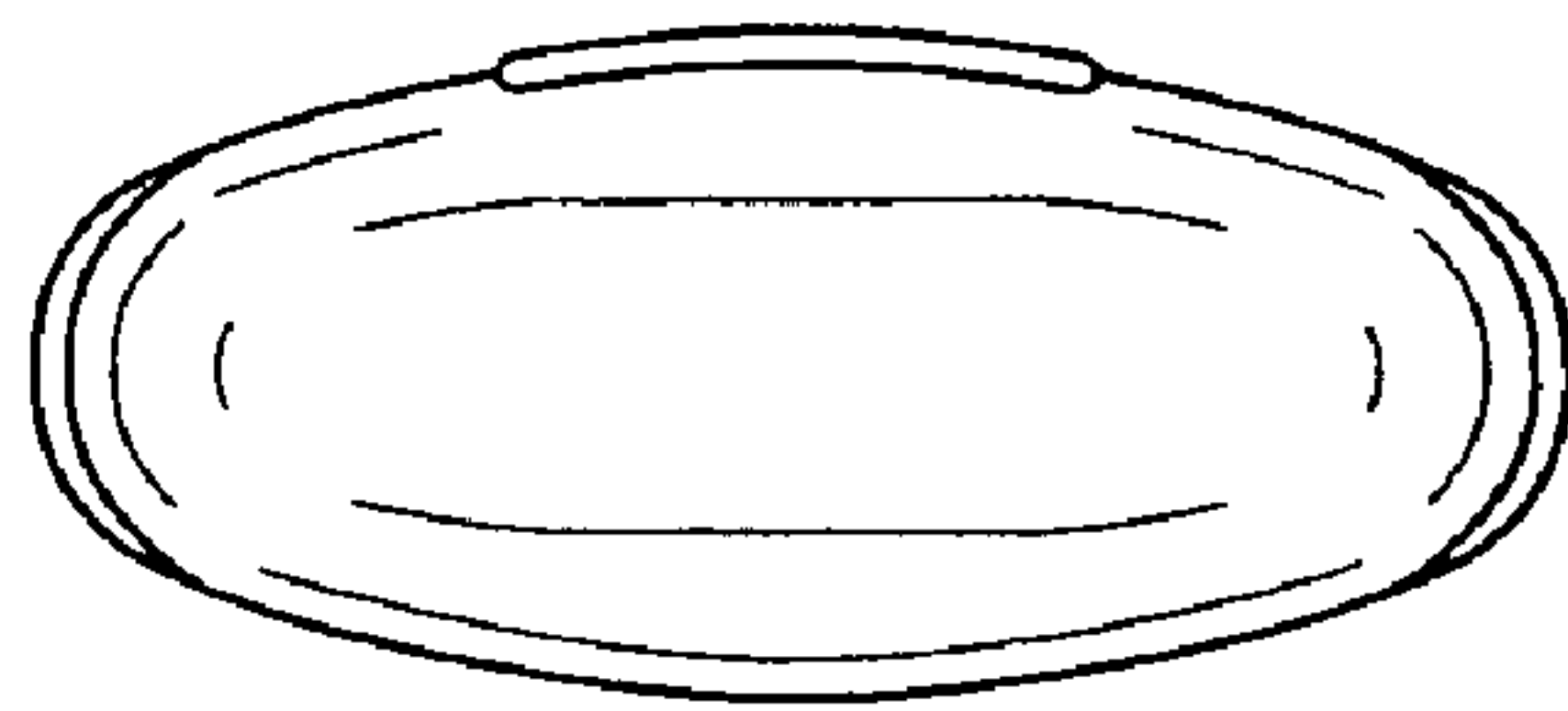
*FIG. 1*



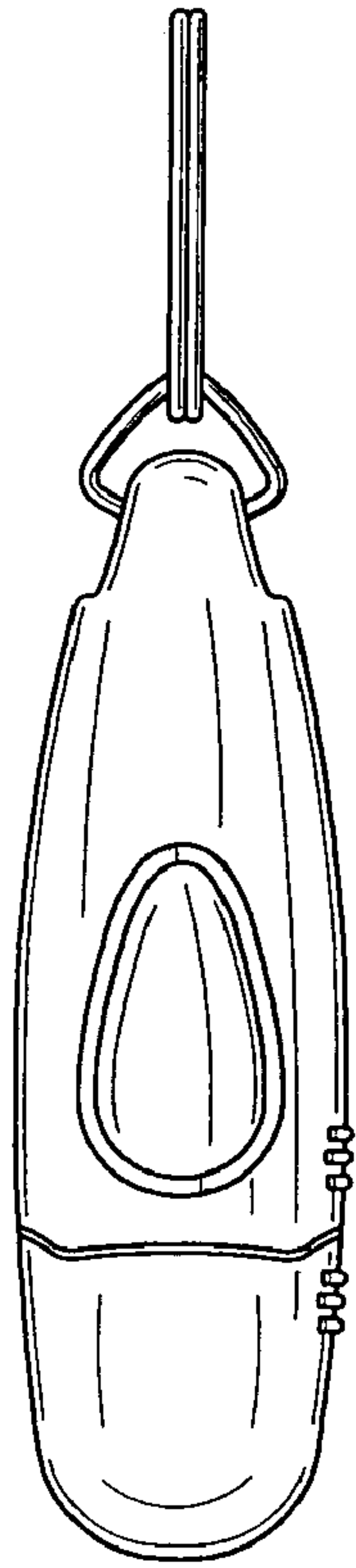
*FIG. 2*



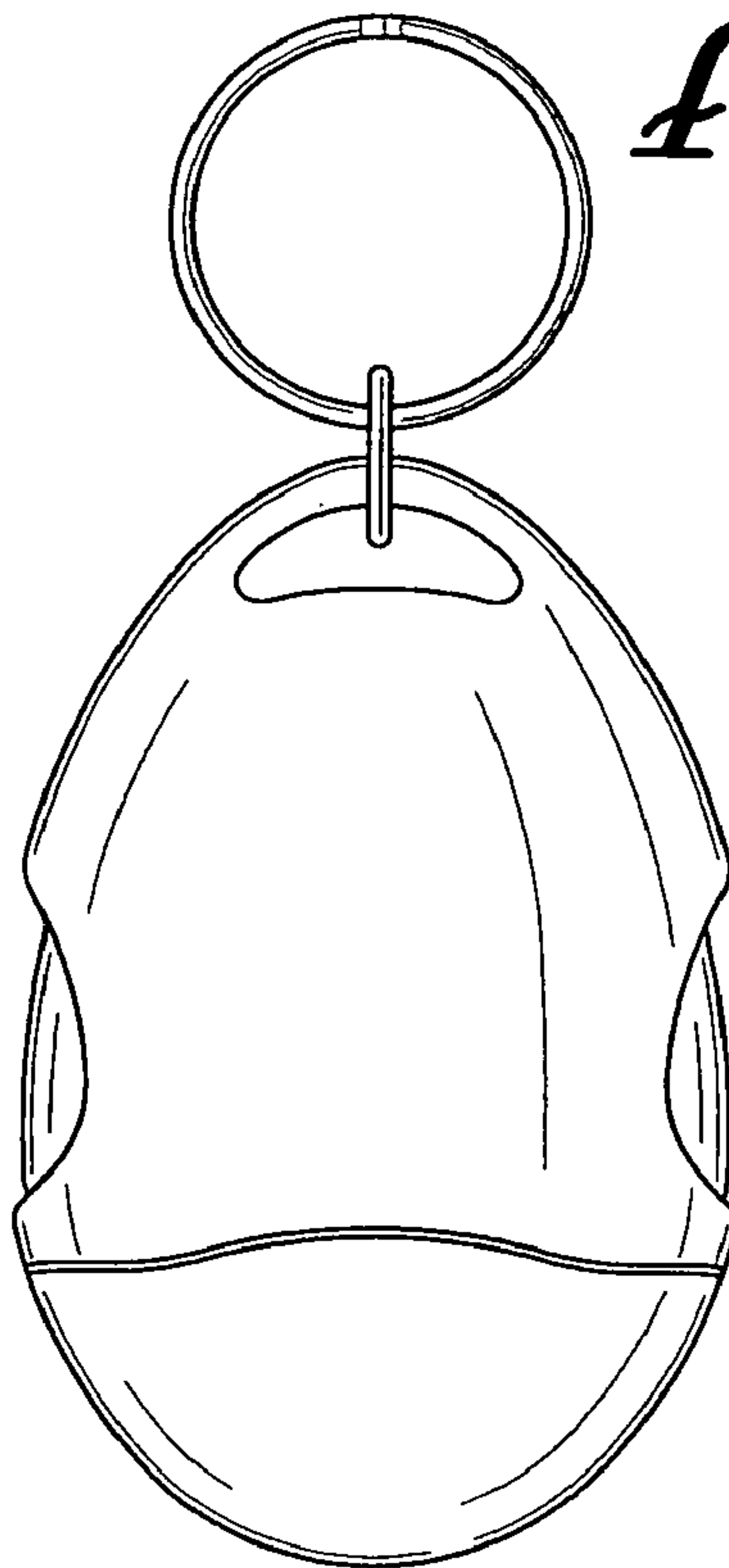
*FIG. 3*



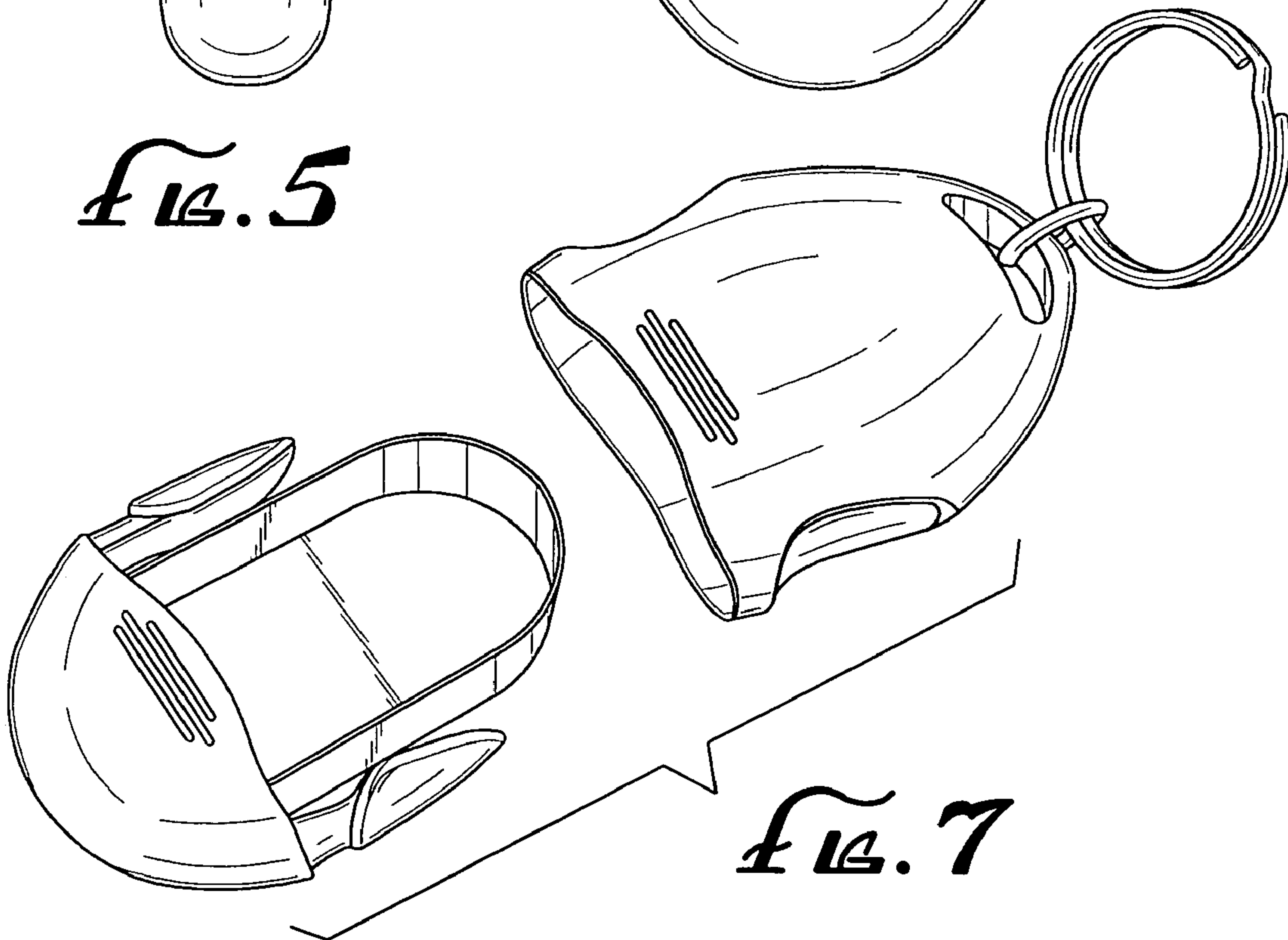
*FIG. 4*



*FIG. 5*



*FIG. 6*



*FIG. 7*