



US00D546020S

(12) **United States Design Patent** (10) **Patent No.:** **US D546,020 S**
Perrier et al. (45) **Date of Patent:** **** Jul. 3, 2007**

(54) **CART HANDLE**

FOREIGN PATENT DOCUMENTS

(75) Inventors: **R. Sylvain Perrier**, Ottawa (CA);
Jeremy List, Ottawa (CA); **Cliff Read**,
Carp (CA); **Jason Busschaert**, Towson,
MD (US); **Mark Edey**, Ottawa (CA);
James D. Miller, Holland Landing
(CA); **Howard W. Overland**, Aurora
(CA)

GB 2307575 A 5/1997
JP 2000-155683 6/2000
WO WO-97/29452 A1 8/1997

(73) Assignee: **Springboard Retail Networks Inc.**,
Ontario (CA)

OTHER PUBLICATIONS

(**) Term: **14 Years**

Interactive Store Guide and item Locator for Deli Kiosk,
www.dumac.com.
Intermedia kiosks—news—Supermarket News, (Apr. 2001).
Wincor Nixdorf; “SNIKEY”; www.wincor-nixdorf.com;
Apr. 7, 2005.
Wincor Nixdorf; “Beetle/NetPOS Scalable Thin Client Ter-
minal”; www.wincor-nixdorf.com; Apr. 15, 2004.
Wincor Nixdorf; “POS Terminal Beetle/IPOS”; www.win-
cor-nixdorf.com; Oct. 15, 2004.
Klever Marketing; “EMarketing’s Billion-Dollar Opportu-
nity”; www.kleverkart.com; 2005; and Fujitsu; “The Fujitsu
Difference—U-Scan Shopper”; www.fujitsu.com; 2005.
Cuesol; “Enhancing the Customer Experience”; www.cue-
sol.com; 2005.

(21) Appl. No.: **29/241,454**

(22) Filed: **Oct. 28, 2005**

(30) **Foreign Application Priority Data**

Apr. 29, 2005 (CA) 110966

(51) **LOC (8) Cl.** **12-02**

(52) **U.S. Cl.** **D34/27**

(58) **Field of Classification Search** D34/12-27;
40/308, 506, 611; 280/33.992, 33.991, 62,
280/47.17, 646; D12/133; 403/312

See application file for complete search history.

Primary Examiner—Freda Nunn

Assistant Examiner—Kevin K. Rudzinaki

(74) *Attorney, Agent, or Firm*—Birch, Stewart, Kolasch &
Birch, LLP

(56) **References Cited**

U.S. PATENT DOCUMENTS

2,759,281 A * 8/1956 Akers, Jr. 40/653
3,251,543 A 5/1966 Bush
3,710,108 A * 1/1973 Haarhaus et al. 235/79
3,836,755 A 9/1974 Ehrat et al.
4,071,740 A 1/1978 Gogulski
4,334,278 A 6/1982 Marmon
4,373,133 A 2/1983 Clyne et al.
4,500,880 A 2/1985 Gomersall et al.
4,750,151 A 6/1988 Baus
4,882,724 A 11/1989 Vela et al.
D307,895 S 5/1990 Kitagawa et al.
4,973,952 A 11/1990 Malec et al.

(57) **CLAIM**

The ornamental design for a cart handle, as shown and
described.

DESCRIPTION

FIG. 1 is a front right perspective view of the cart handle;
FIG. 2 is a rear perspective view of the cart handle of FIG.
1;
FIG. 3 is a front elevation view of the cart handle of FIG. 1;
FIG. 4 is a rear elevation view of the cart handle of FIG. 1;
FIG. 5 is a top plan view of the cart handle of FIG. 1;
FIG. 6 is a bottom plan view of the cart handle of FIG. 1;
FIG. 7 is a left side view of the cart handle of FIG. 1; and,
FIG. 8 is a right side view of the cart handle of FIG. 1.

(Continued)

1 Claim, 5 Drawing Sheets

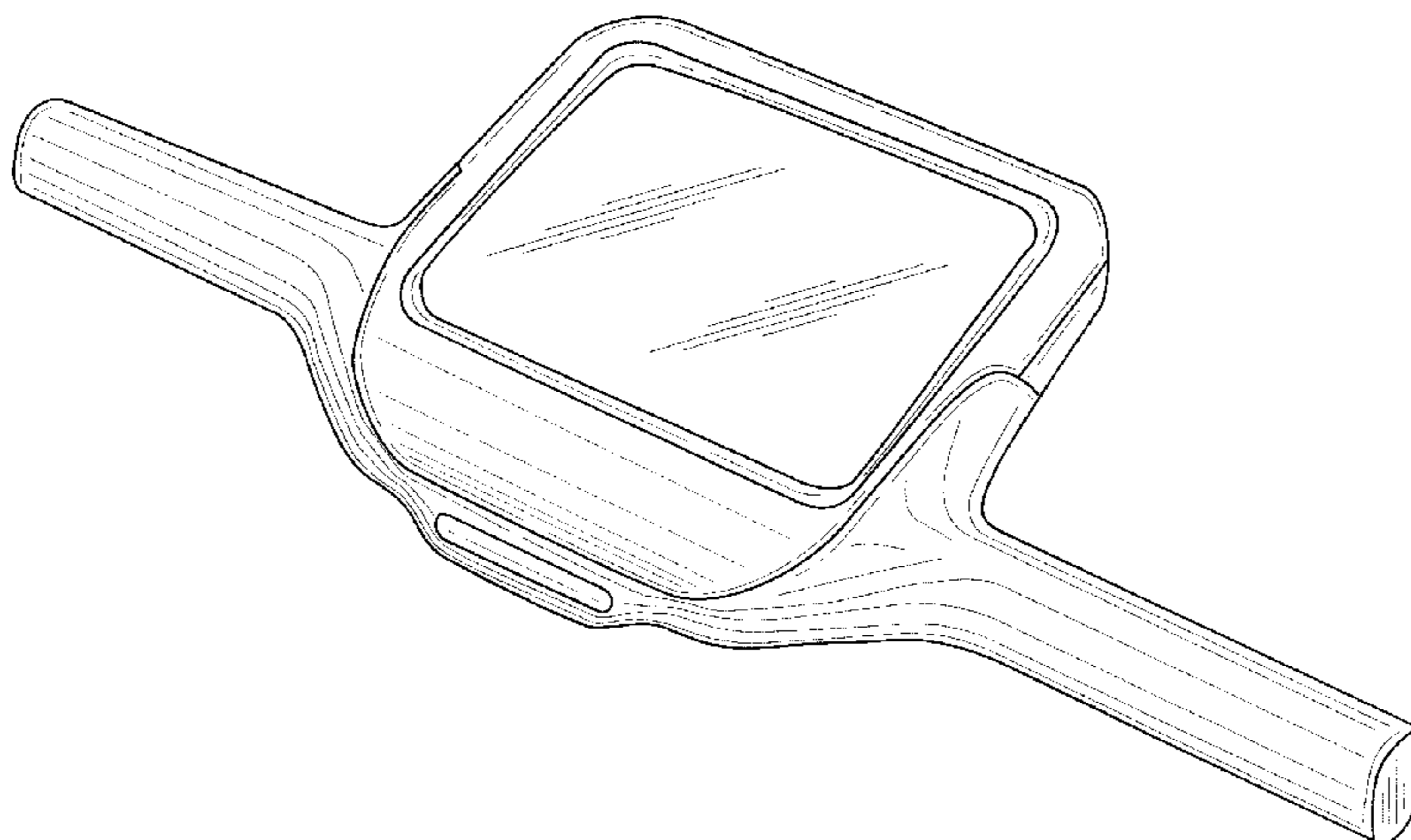

US D546,020 S

Page 2

U.S. PATENT DOCUMENTS

4,988,025 A	1/1991	Lipton et al.	6,123,259 A	9/2000	Ogasawara
5,149,947 A	9/1992	Collins, Jr.	6,129,276 A	10/2000	Jelen et al.
5,158,310 A	10/1992	Tannehill et al.	6,168,079 B1	1/2001	Becker et al.
5,250,789 A	10/1993	Johnsen	6,177,880 B1	1/2001	Begum
D341,691 S	* 11/1993	Begum et al. D34/27	6,189,788 B1	2/2001	Sherman et al.
5,287,266 A	2/1994	Malec et al.	D438,849 S	3/2001	Adachi et al.
5,295,064 A	3/1994	Malec et al.	6,199,753 B1	3/2001	Tracy et al.
D346,366 S	4/1994	Kim et al.	6,323,753 B2	11/2001	Begum
5,301,443 A	* 4/1994	Gori 40/308	6,327,570 B1	12/2001	Stevens
D347,505 S	* 5/1994	Machen et al. D34/15	D454,563 S	3/2002	Brown et al.
D347,719 S	* 6/1994	Machen et al. D34/15	6,386,450 B1	5/2002	Ogasawara
D354,485 S	1/1995	Maeno et al.	D460,759 S	7/2002	West et al.
5,406,271 A	4/1995	Sonnendorfer et al.	6,434,530 B1	8/2002	Sloane et al.
5,420,606 A	5/1995	Begum et al.	6,435,407 B1	8/2002	Fiordelisi
5,424,524 A	6/1995	Ruppert et al.	6,453,588 B1	* 9/2002	Lykens 40/308
5,457,307 A	10/1995	Dumont	6,456,981 B1	9/2002	Dejaeger et al.
5,483,472 A	1/1996	Overman	D464,646 S	10/2002	Lin
5,544,040 A	8/1996	Gerbaulet	6,484,939 B1	11/2002	Blaeuer
D375,601 S	* 11/1996	Myers D34/27	6,513,015 B2	1/2003	Ogasawara
D376,459 S	* 12/1996	Myers D34/27	6,533,173 B2	3/2003	Benyak
5,630,068 A	5/1997	Vela et al.	6,539,417 B2	3/2003	Stern
5,630,071 A	5/1997	Sakai et al.	6,595,417 B2	7/2003	O'Hagan et al.
5,703,564 A	12/1997	Begum et al.	6,619,546 B1	9/2003	Nguyen et al.
D390,861 S	2/1998	Liao	D480,760 S	10/2003	Wieth et al.
5,714,745 A	2/1998	Ju et al.	D481,057 S	10/2003	Brady et al.
D392,259 S	3/1998	Simmon	D482,172 S	* 11/2003	Johnson et al. D34/27
5,729,697 A	3/1998	Schkolnick et al.	D483,361 S	12/2003	Yao et al.
5,739,513 A	4/1998	Watanabe	6,725,206 B1	4/2004	Coveley
5,773,954 A	6/1998	VanHorn	D492,303 S	6/2004	Schlieffers et al.
5,821,512 A	10/1998	O'Hagan et al.	D494,970 S	8/2004	Chen et al.
5,821,513 A	10/1998	O'Hagan et al.	D495,703 S	9/2004	Ma et al.
5,836,051 A	* 11/1998	Myers 16/436	6,845,656 B2	1/2005	Matsumura et al.
5,841,115 A	11/1998	Shepley	6,854,656 B2	2/2005	Matsumori
D404,761 S	1/1999	Tarpenning et al.	6,910,697 B2	6/2005	Varatharajah et al.
5,859,414 A	1/1999	Grimes et al.	6,912,398 B1	6/2005	Domnitz
5,890,135 A	3/1999	Powell	6,928,343 B2	8/2005	Cato
5,898,158 A	4/1999	Shimizu et al.	D509,827 S	9/2005	Johnson
5,918,211 A	6/1999	Sloane	D510,784 S	* 10/2005	Van Ledingham, Jr. D34/27
5,979,757 A	11/1999	Tracy et al.	D511,547 S	11/2005	Andersson et al.
5,984,182 A	11/1999	Murrah et al.	2001/0007450 A1	7/2001	Begum
6,000,610 A	12/1999	Talbott et al.	2001/0028301 A1	10/2001	Geiger et al.
6,012,244 A	1/2000	Begum et al.	2002/0165778 A1	11/2002	O'Hagan et al.
6,032,127 A	2/2000	Schkolnick et al.	2003/0132298 A1	7/2003	Swartz et al.
6,105,867 A	8/2000	Shimizu et al.	2004/0073489 A1	4/2004	Varatharajah et al.
6,112,857 A	9/2000	Morrison	2004/0215530 A1	10/2004	Rawson et al.
6,119,935 A	9/2000	Jelen et al.	2005/0040230 A1	2/2005	Swartz et al.

* cited by examiner

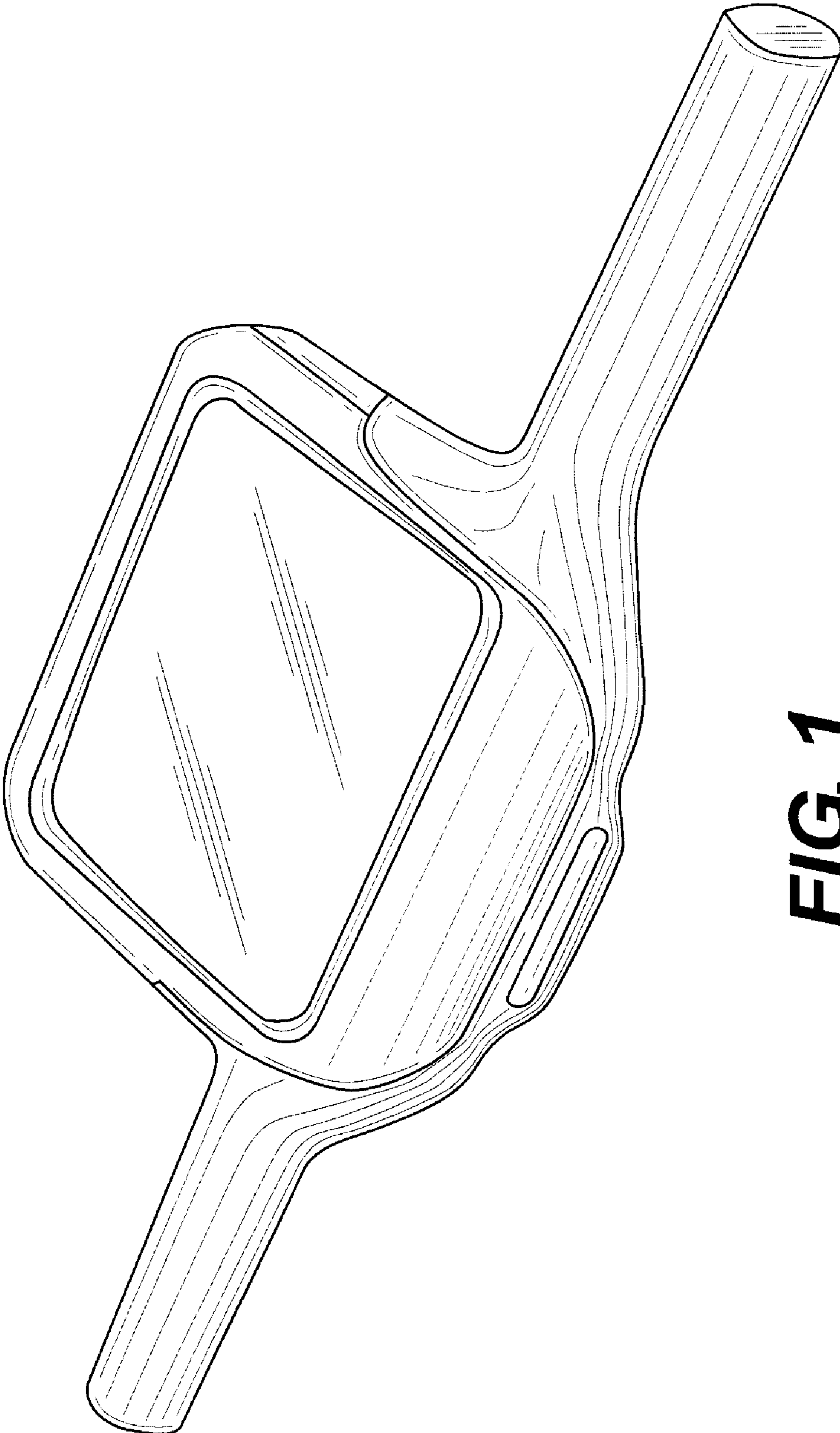

FIG. 1

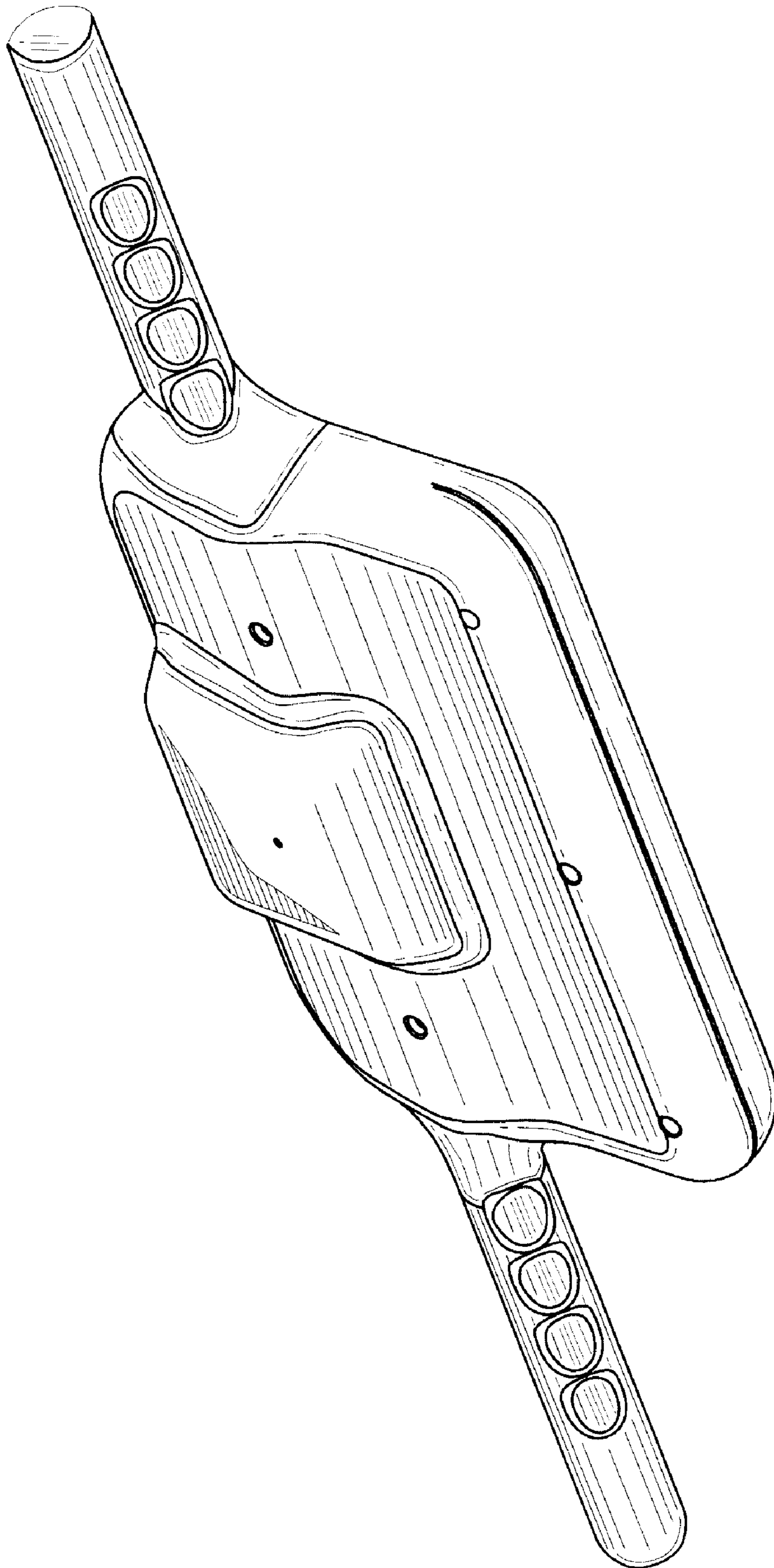

FIG. 2

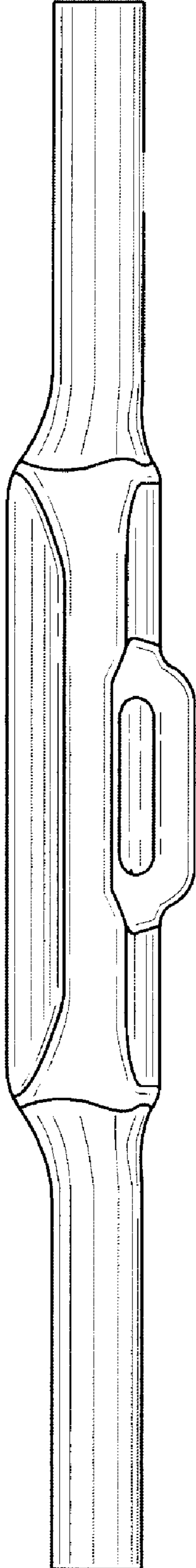

FIG. 3

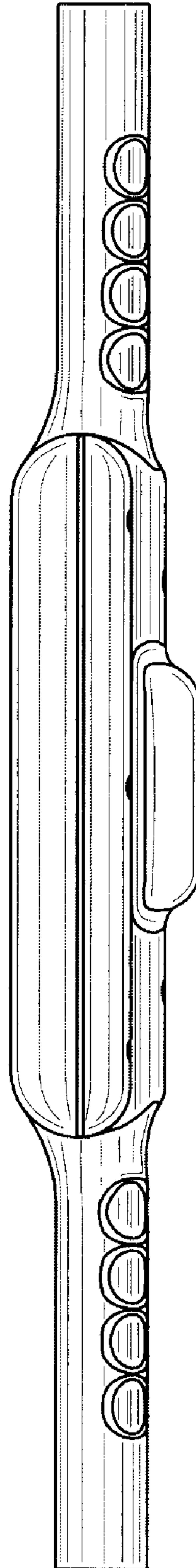

FIG. 4

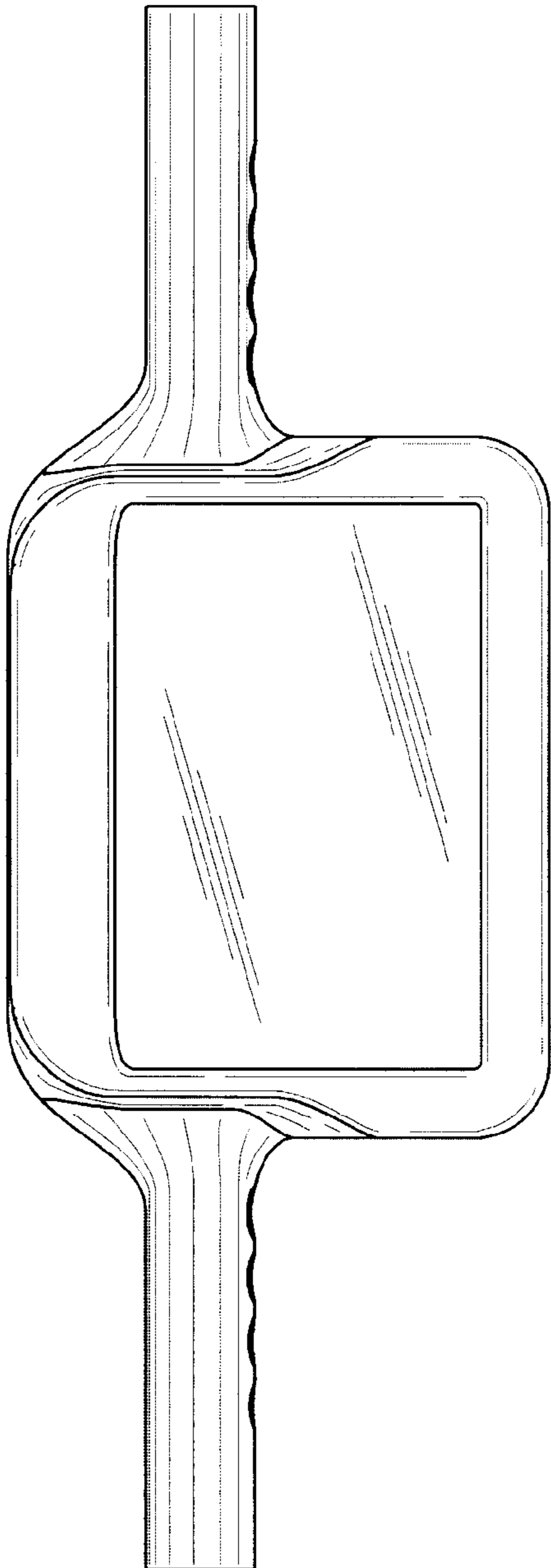

FIG. 5

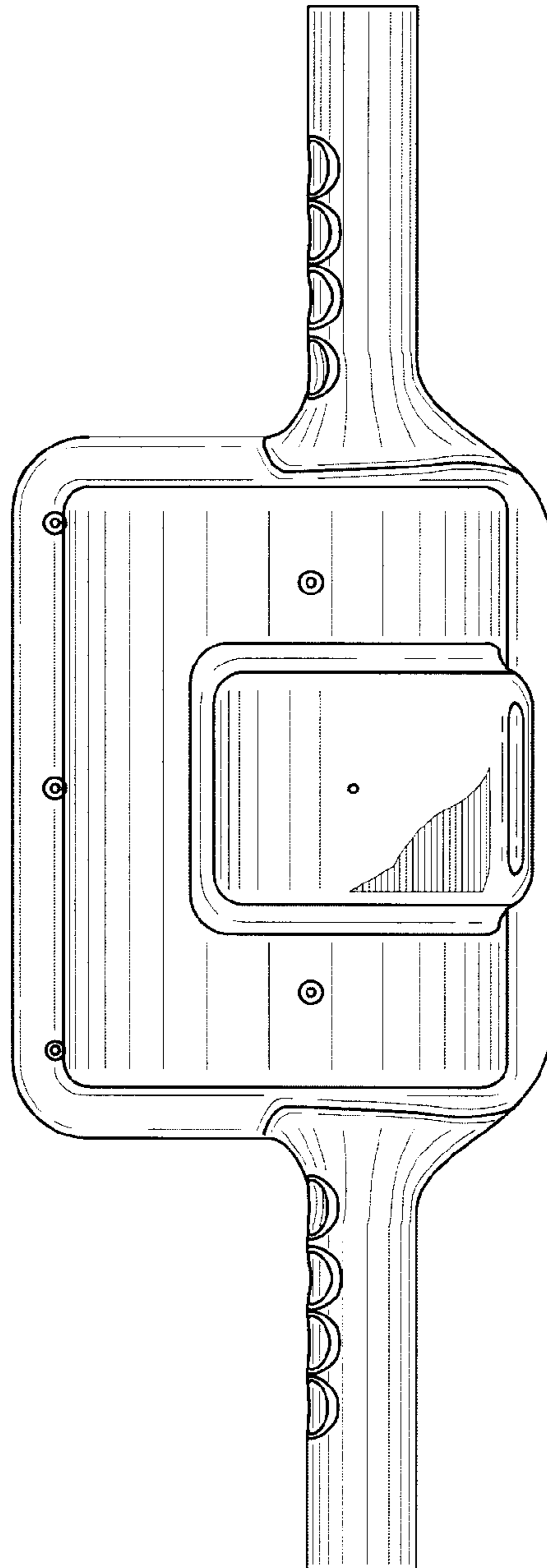

FIG. 6

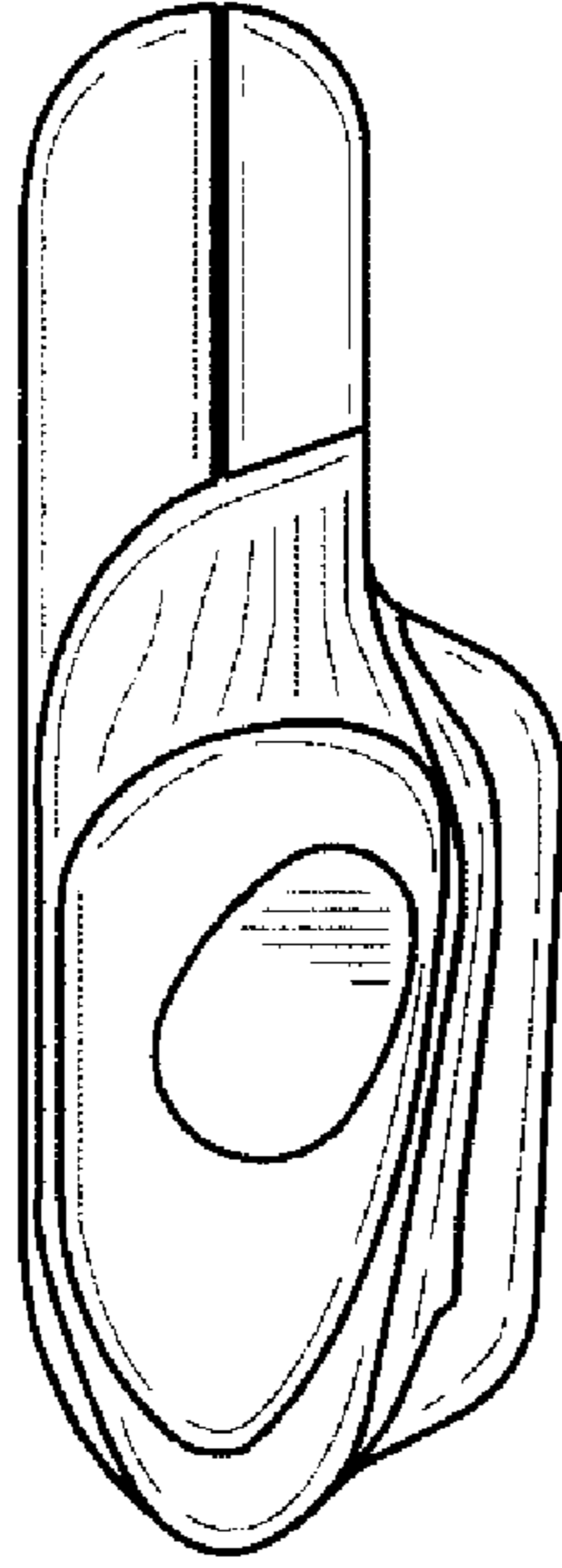

FIG. 8

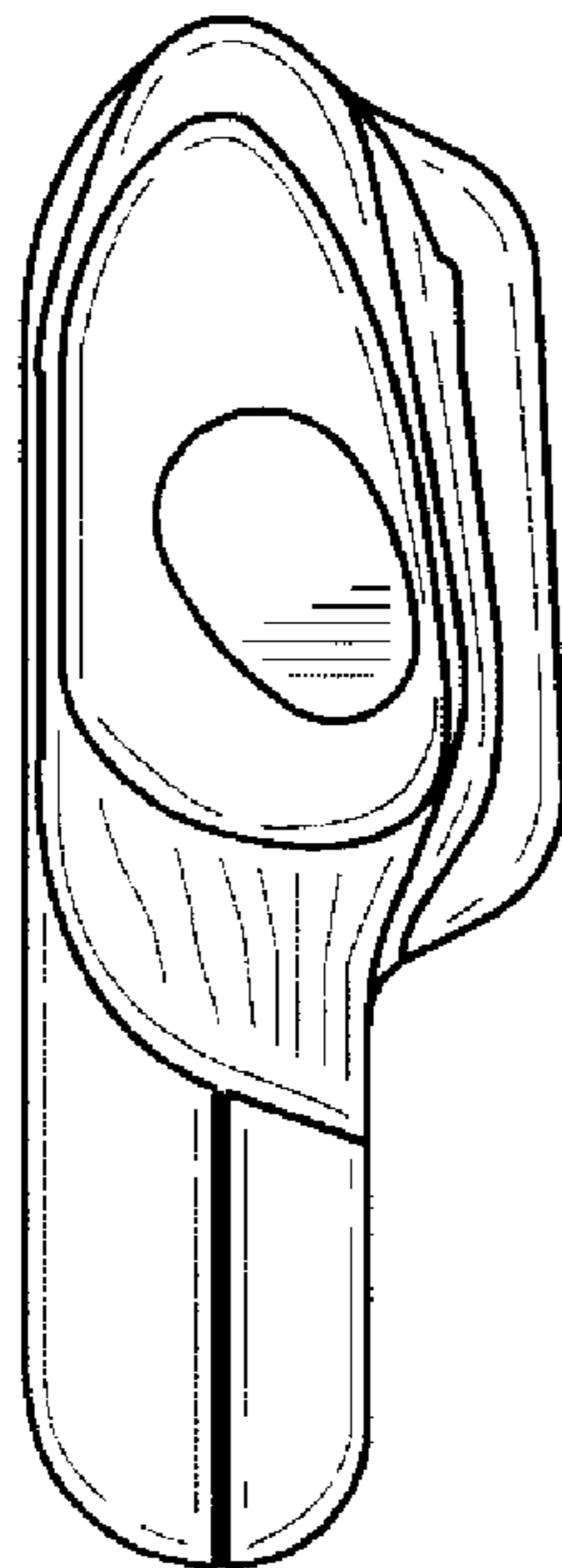

FIG. 7