



US00D545985S

(12) **United States Design Patent**
Garrity

(10) **Patent No.:** **US D545,985 S**

(45) **Date of Patent:** **** Jul. 3, 2007**

(54) **FLASHLIGHT**

(75) Inventor: **Kevin S. Garrity**, Madison, CT (US)

(73) Assignee: **Garrity Industries, Inc.**, Madison, CT (US)

(**) Term: **14 Years**

(21) Appl. No.: **29/259,174**

(22) Filed: **May 4, 2006**

(51) **LOC (8) Cl.** **26-02**

(52) **U.S. Cl.** **D26/49**

(58) **Field of Classification Search** D26/37,
D26/38, 46, 48, 49, 50, 51, 52; 362/157,
362/158, 171-174, 178, 183, 196, 199, 201,
362/202, 203, 204, 205, 208, 266
See application file for complete search history.

(56) **References Cited**

U.S. PATENT DOCUMENTS

D263,258 S *	3/1982	Zeller	D26/49
D297,770 S *	9/1988	Garrity, Sr.	D26/49
D370,989 S *	6/1996	Garrity	D26/49
D374,495 S *	10/1996	Garrity	D26/49
D420,157 S *	2/2000	Garrity et al.	D26/49
D433,523 S *	11/2000	Poon	D26/49
D443,373 S *	6/2001	Israel et al.	D26/49

D484,627 S *	12/2003	Mah	D26/49
D486,937 S *	2/2004	Shiu	D26/49
D498,865 S *	11/2004	Mah	D26/49
D531,746 S *	11/2006	Zhu	D26/49

* cited by examiner

Primary Examiner—Ian Simmons

Assistant Examiner—Carissa Fitts

(74) *Attorney, Agent, or Firm*—Fitzpatrick, Cella, Harper & Scinto

(57) **CLAIM**

The ornamental design for a flashlight, as shown and described.

DESCRIPTION

FIG. 1 is a perspective view as viewed from a front direction thereof of a flashlight showing our new design;

FIG. 2 is a top view thereof;

FIG. 3 is a right side view thereof;

FIG. 4 is a bottom view thereof;

FIG. 5 is a left side view thereof;

FIG. 6 is a front view thereof; and,

FIG. 7 is a rear view thereof.

1 Claim, 3 Drawing Sheets

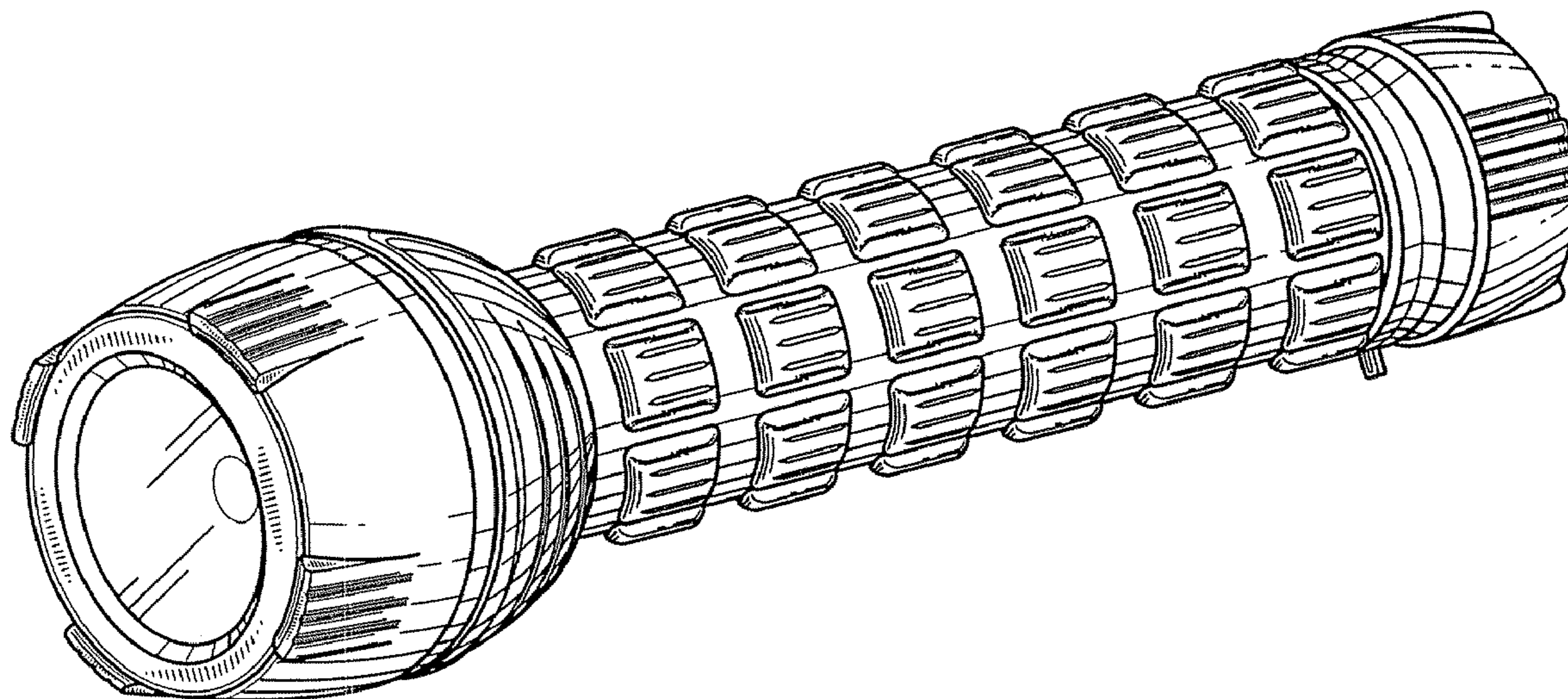

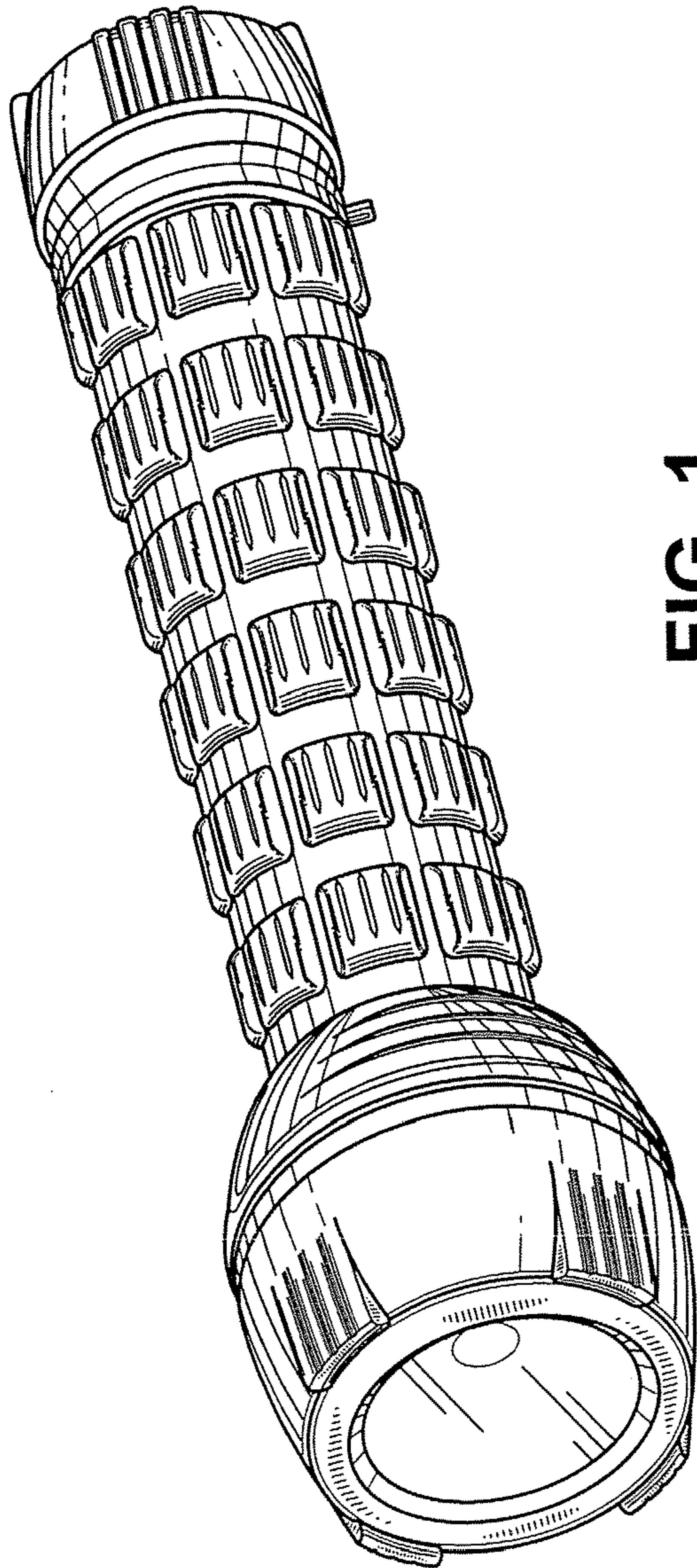

FIG. 1

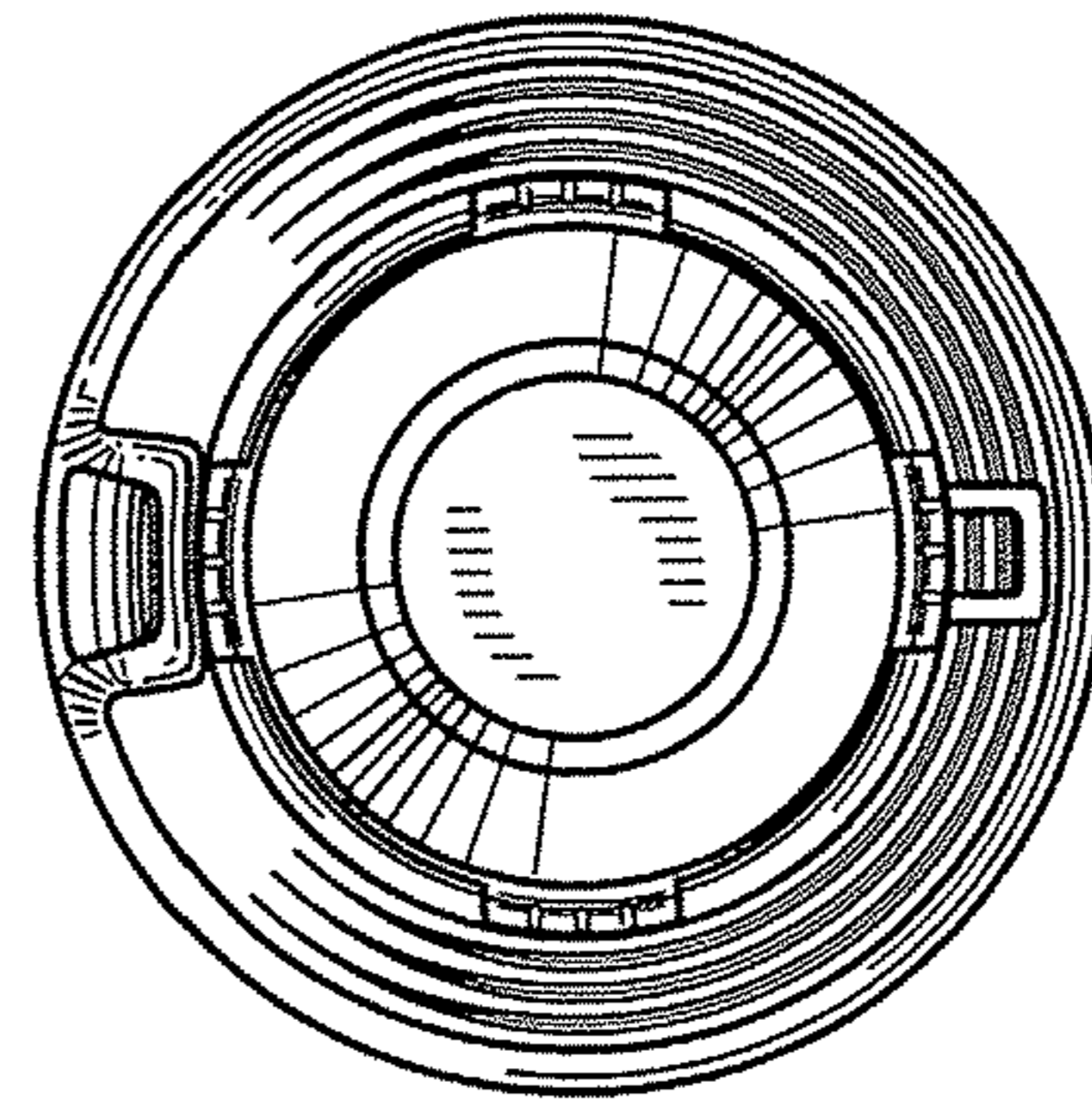

FIG. 7

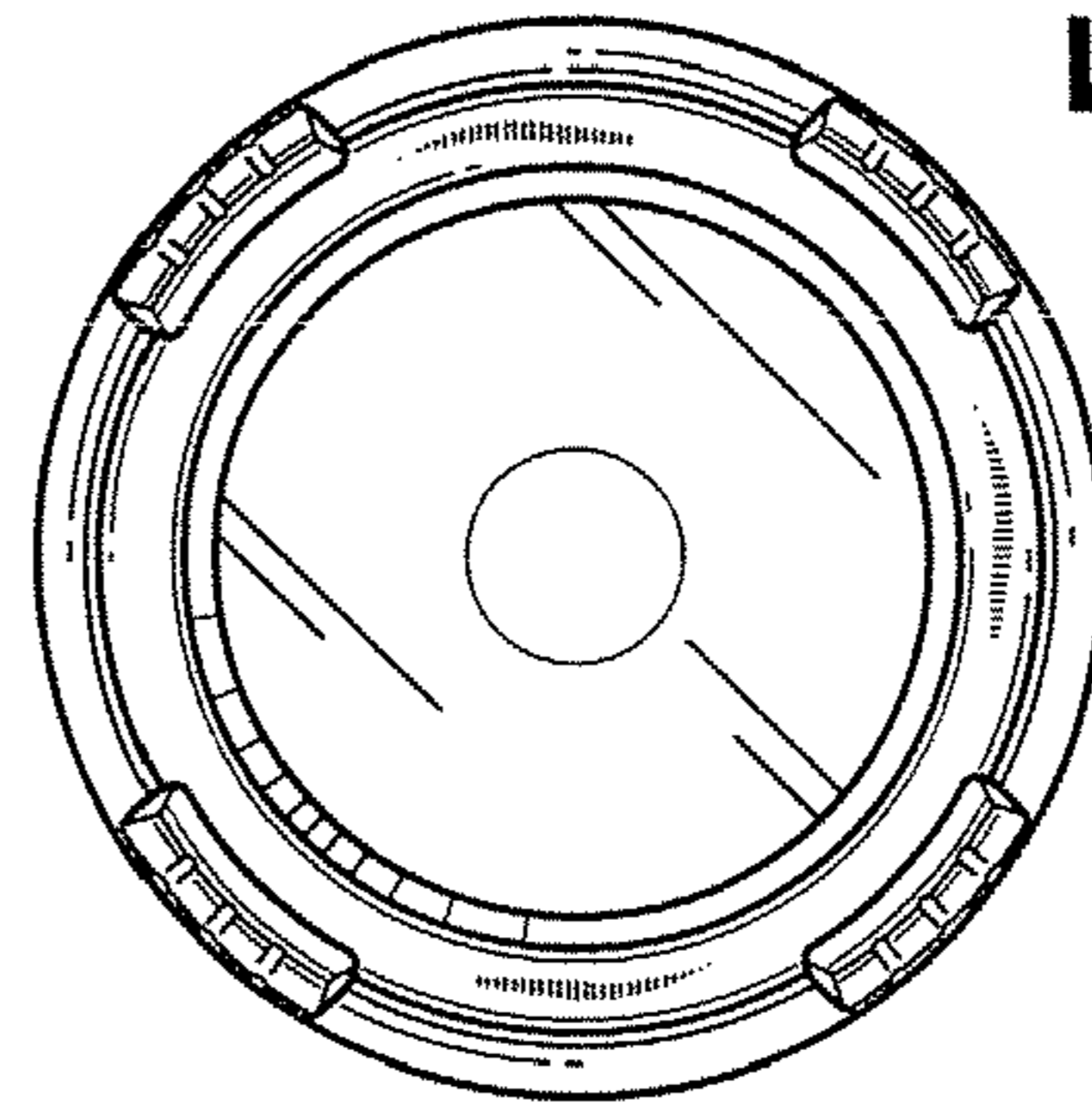

FIG. 6

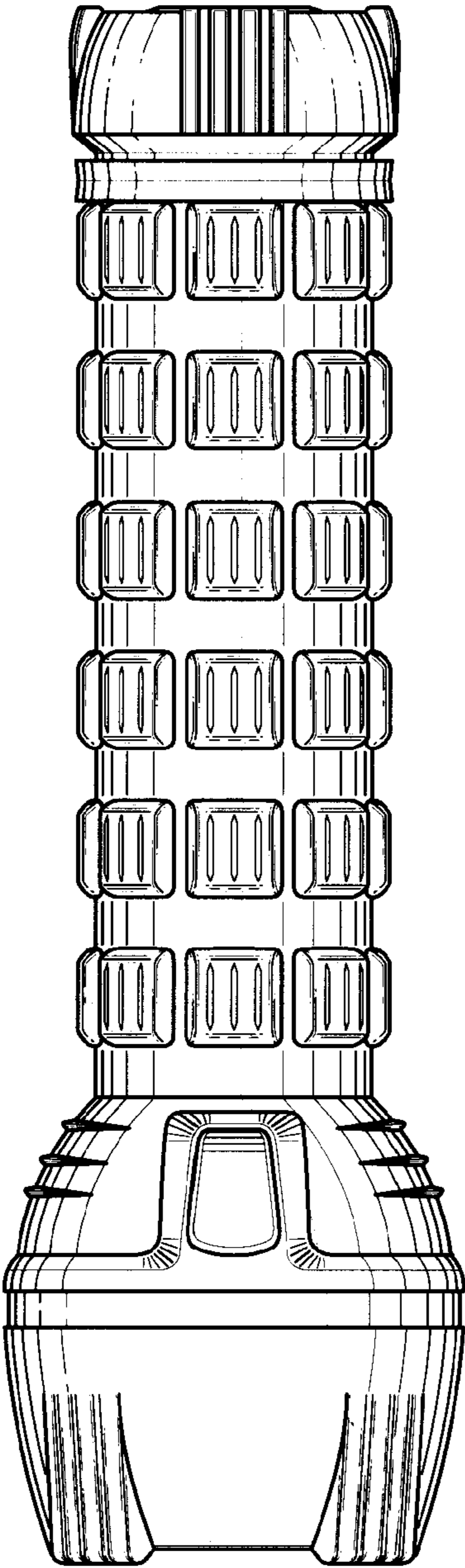

FIG. 2

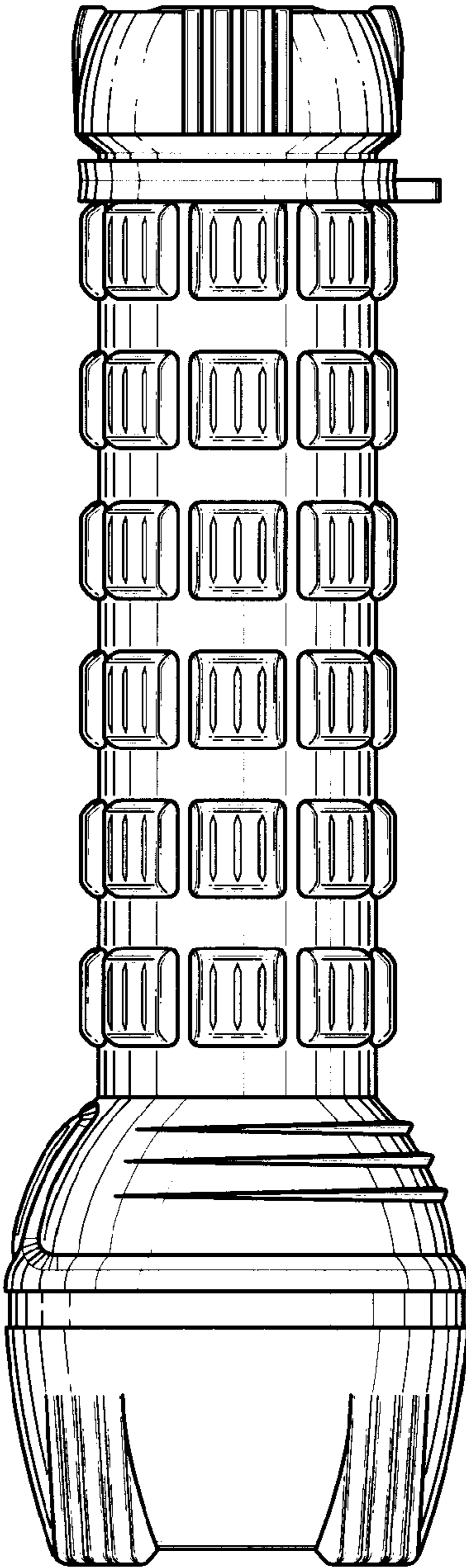

FIG. 3

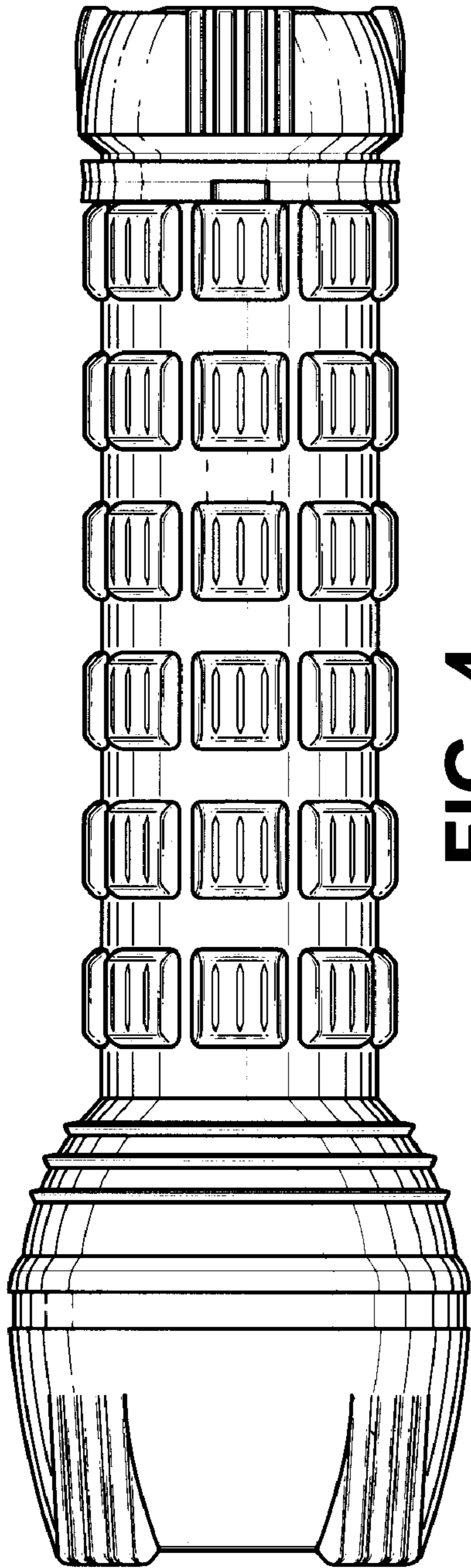

FIG. 4

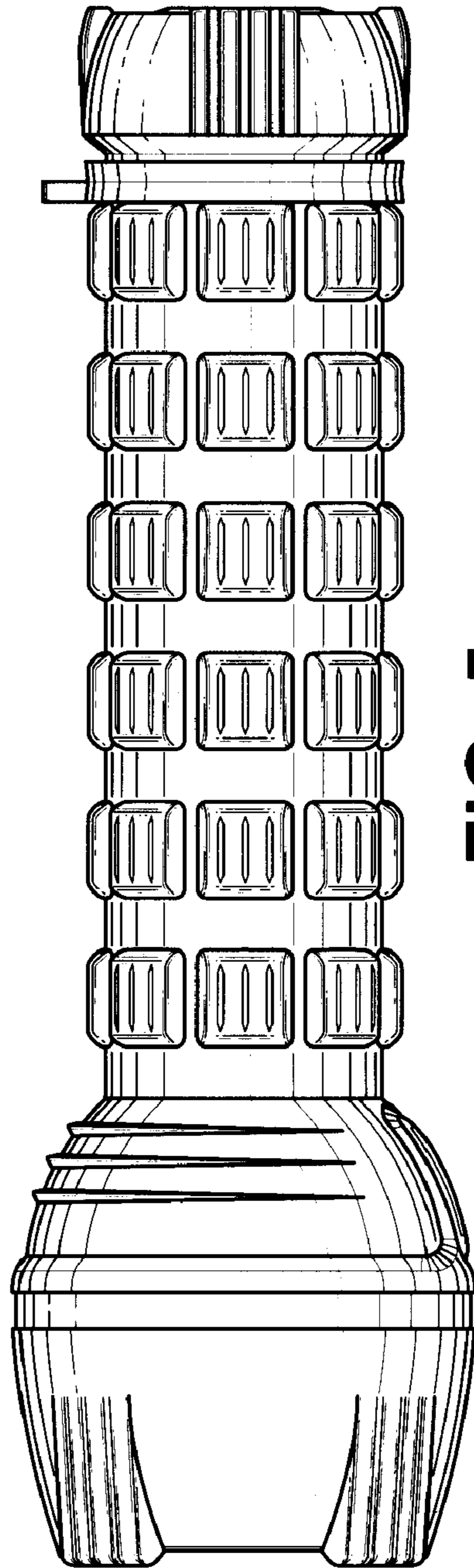

FIG. 5