

US00D545951S

(12) **United States Design Patent**
Bucher et al.

(10) **Patent No.:** **US D545,951 S**
(45) **Date of Patent:** **** Jul. 3, 2007**

(54) **TOWER HEATER/FAN WITH ANGLED SIDE PANELS OVER AN AIR DEFLECTOR GRID, ANGLED TOP ANGLED BOTTOM**

D476,724 S 7/2003 Chuang et al. D23/335

(Continued)

(75) Inventors: **John C. Bucher**, Hillsboro Beach, FL (US); **Chad Ricker**, North Lauderdale, FL (US); **William Ross Boswell**, Bentonville, AR (US)

Primary Examiner—Louis S. Zarfes
Assistant Examiner—Eric L. Goodman
(74) *Attorney, Agent, or Firm*—Brian S. Steinberger; Law Offices of Brian S. Steinberger, P.A.

(73) Assignee: **King of Fans, Inc.**, Ft. Lauderdale, FL (US)

(57) **CLAIM**

The ornamental design for a novel tower heater/fan with angled side panels over an air deflector grid, angled top, angled bottom, as shown and described.

(**) Term: **14 Years**

(21) Appl. No.: **29/267,190**

(22) Filed: **Oct. 6, 2006**

Related U.S. Application Data

(62) Division of application No. 29/241,073, filed on Oct. 21, 2005.

(51) **LOC (8) Cl.** **23-03**

(52) **U.S. Cl.** **D23/335**

(58) **Field of Classification Search** D23/332,
D23/314, 335-337, 340-345, 349-350; 392/360,
392/365-369, 373-376; 312/326; 126/110 B,
126/90 A, 92 A

See application file for complete search history.

(56) **References Cited**

U.S. PATENT DOCUMENTS

D290,997 S *	7/1987	Utsuki et al.	D23/378
D322,669 S	12/1991	Yamamoto et al.	D23/378
D329,284 S	9/1992	Patton	D23/378
D340,971 S	11/1993	Pirro	D23/370
5,278,936 A	1/1994	Shao	392/365
D348,724 S	7/1994	Lee	D23/328
D410,074 S	5/1999	Lee	D23/332
D423,093 S	4/2000	Fok et al.	D23/378
D429,323 S	8/2000	Rossman et al.	D23/341
D464,723 S	10/2002	Fok et al.	D23/378
D468,415 S	1/2003	Moreno et al.	D23/341
D476,404 S	6/2003	Chen et al.	D23/341

DESCRIPTION

FIG. 1 is a left front side perspective view of a novel tower heater/fan with angled side panels angled top and angled bottom.

FIG. 2 is right front side perspective view of the novel tower heater/fan of FIG. 1.

FIG. 3 is a left rear perspective view of the novel tower heater/fan design of FIG. 1.

FIG. 4 is a right rear perspective view of the novel tower heater/fan design of FIG. 1.

FIG. 5 is a left side view of the novel tower heater/fan design of FIG. 1.

FIG. 6 is a right side view of the novel tower heater/fan design of FIG. 1.

FIG. 7 is a front view of the novel tower heater/fan design of FIG. 1.

FIG. 8 is a rear view of the novel tower heater/fan design of FIG. 1; and,

FIG. 9 is top view of the novel tower heater/fan design of FIG. 1.

The broken lines showing a control panel and buttons, front grid, rear grid and stand in FIGS. 1-9 are for illustrative purposes only and forms no part of the claimed invention for those figures.

1 Claim, 9 Drawing Sheets

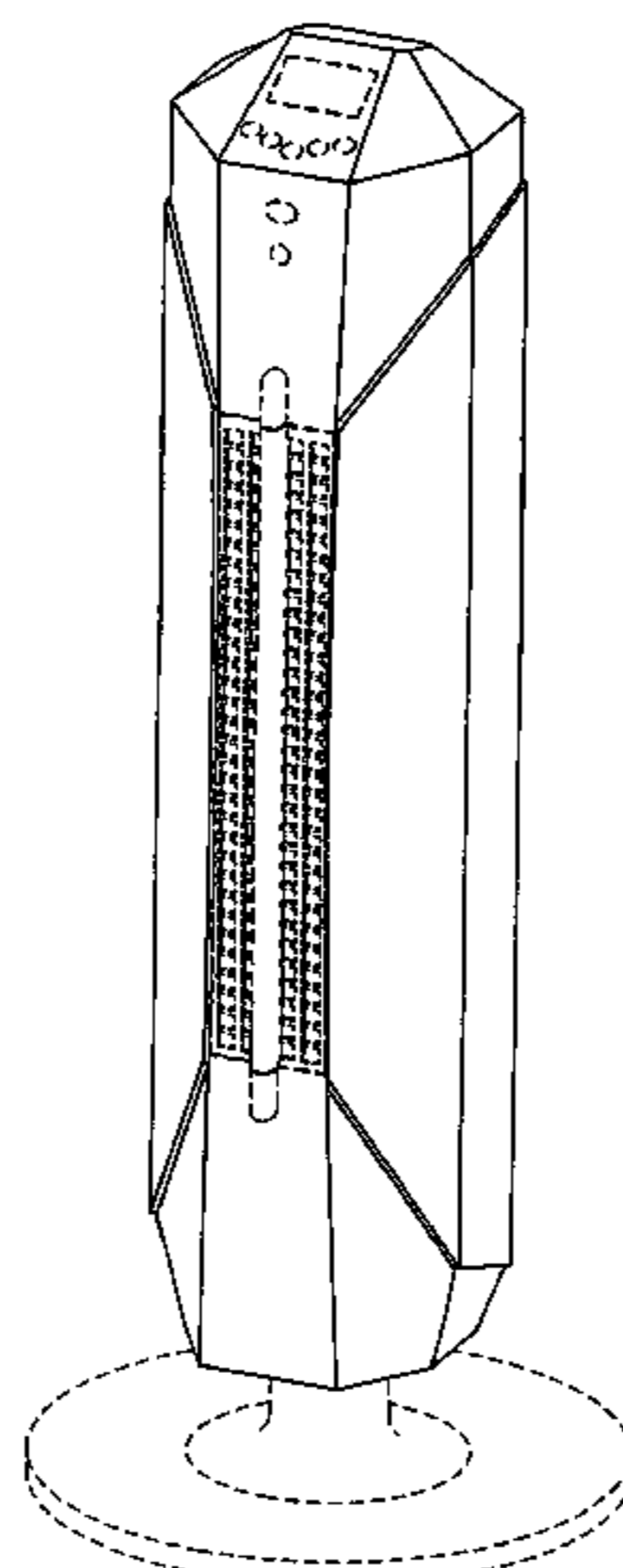

US D545,951 S

Page 2

U.S. PATENT DOCUMENTS

D479,874 S	9/2003	Shapiro	D23/378	D516,687 S *	3/2006	Shapiro	D23/332
D499,473 S *	12/2004	Ching	D23/332	D519,196 S *	4/2006	Blateri	D23/335
D508,734 S *	8/2005	Gao	D23/335	2004/0218912 A1 *	11/2004	Shapiro et al.	392/365
D510,989 S *	10/2005	Dooley	D23/335	2005/0078952 A1 *	4/2005	Bain et al.	392/360

* cited by examiner

Fig. 1

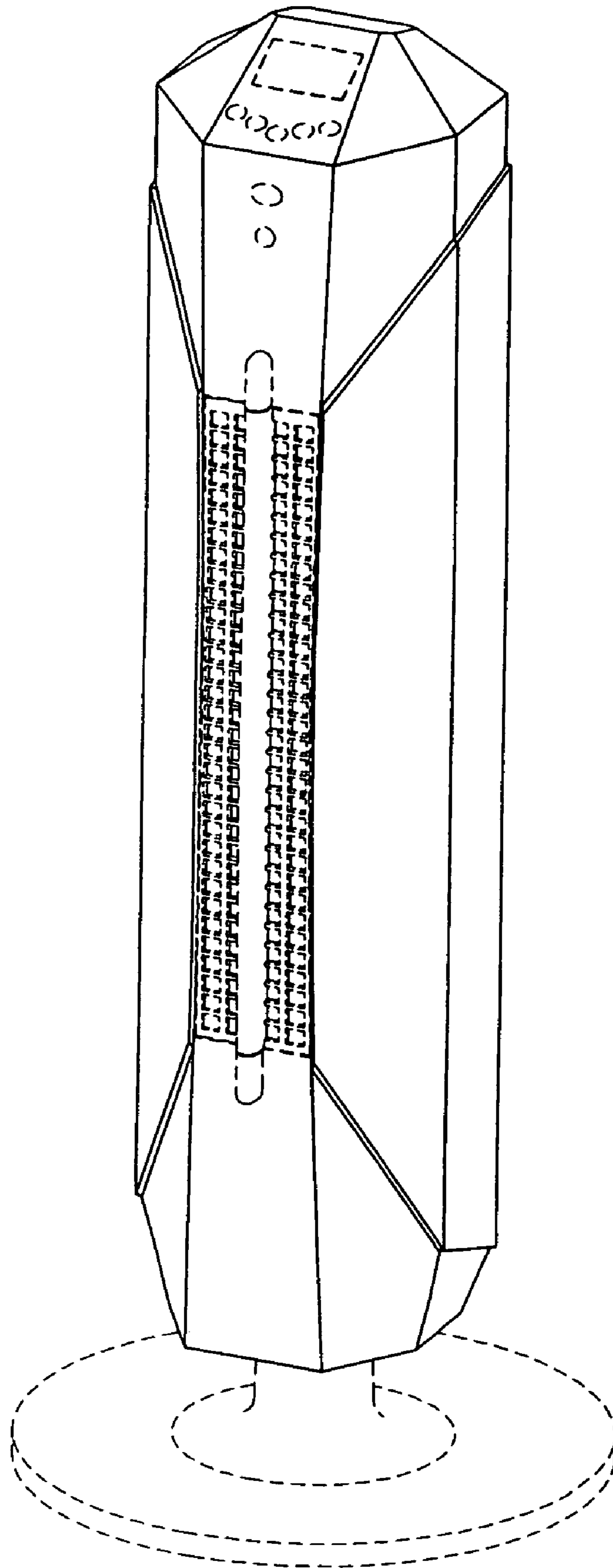

Fig. 2

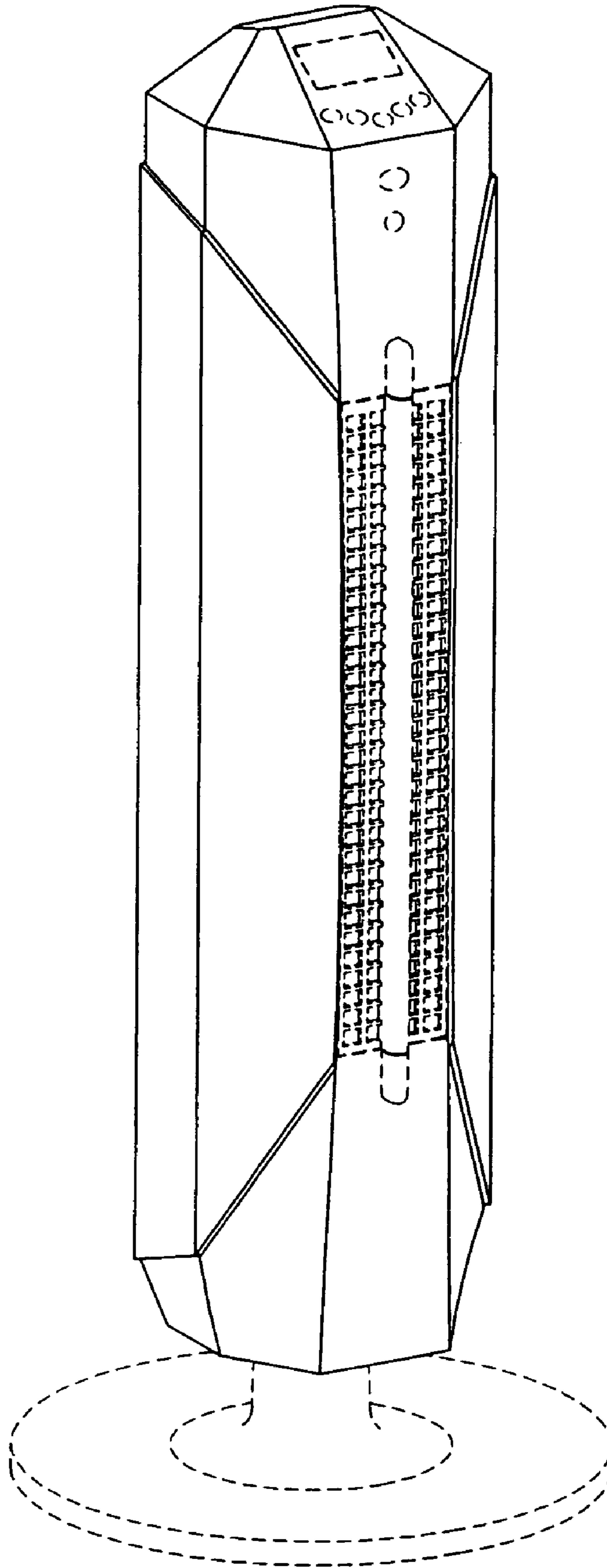

Fig. 3

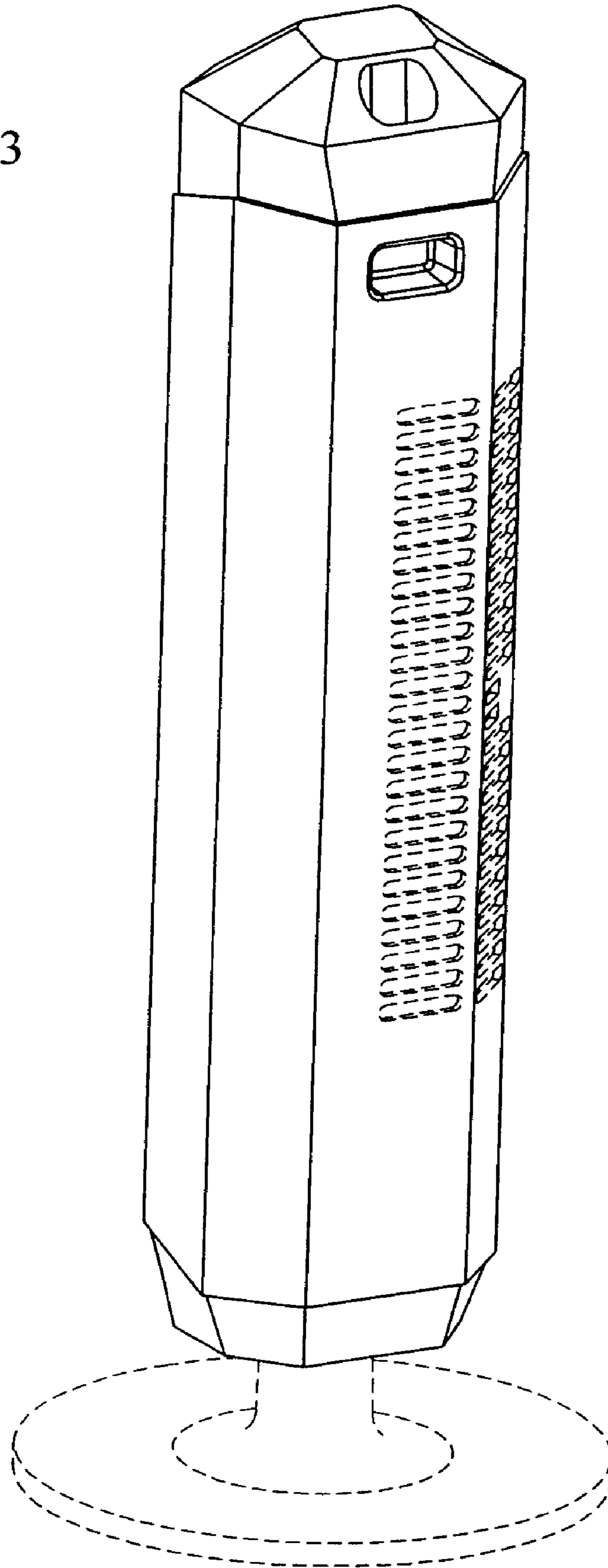

Fig. 4

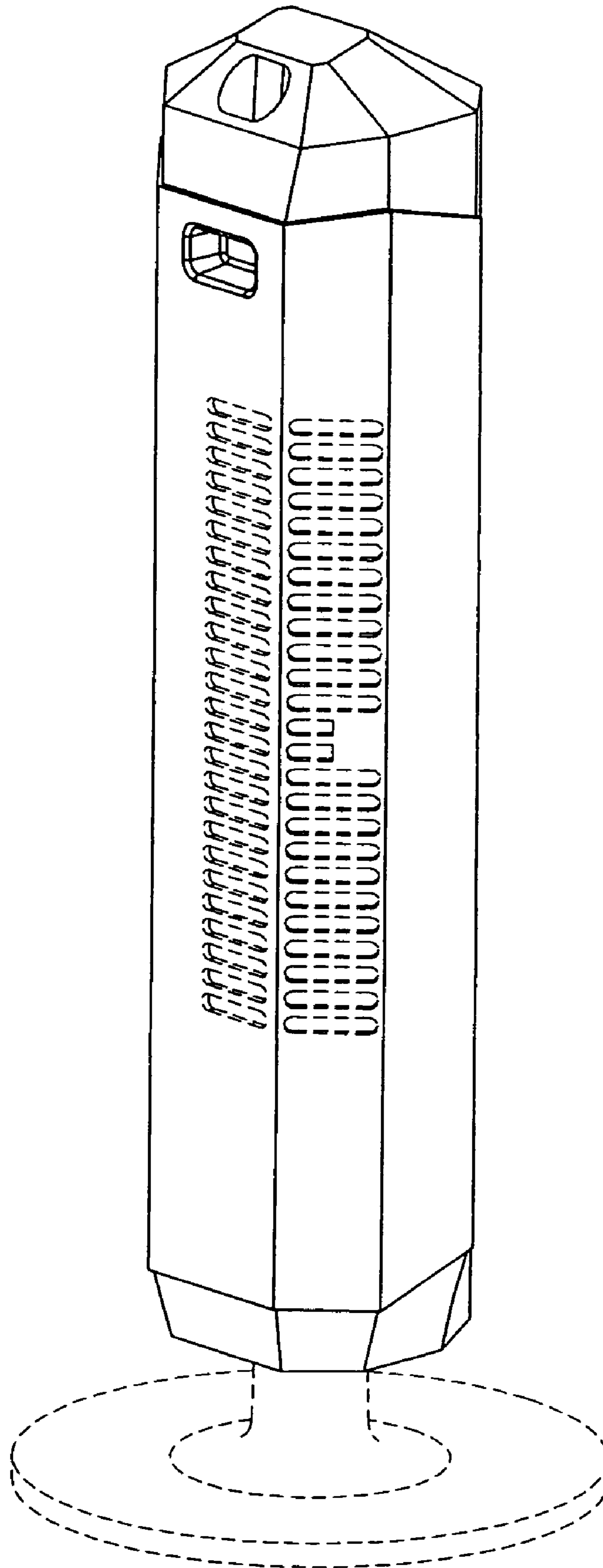

Fig. 5

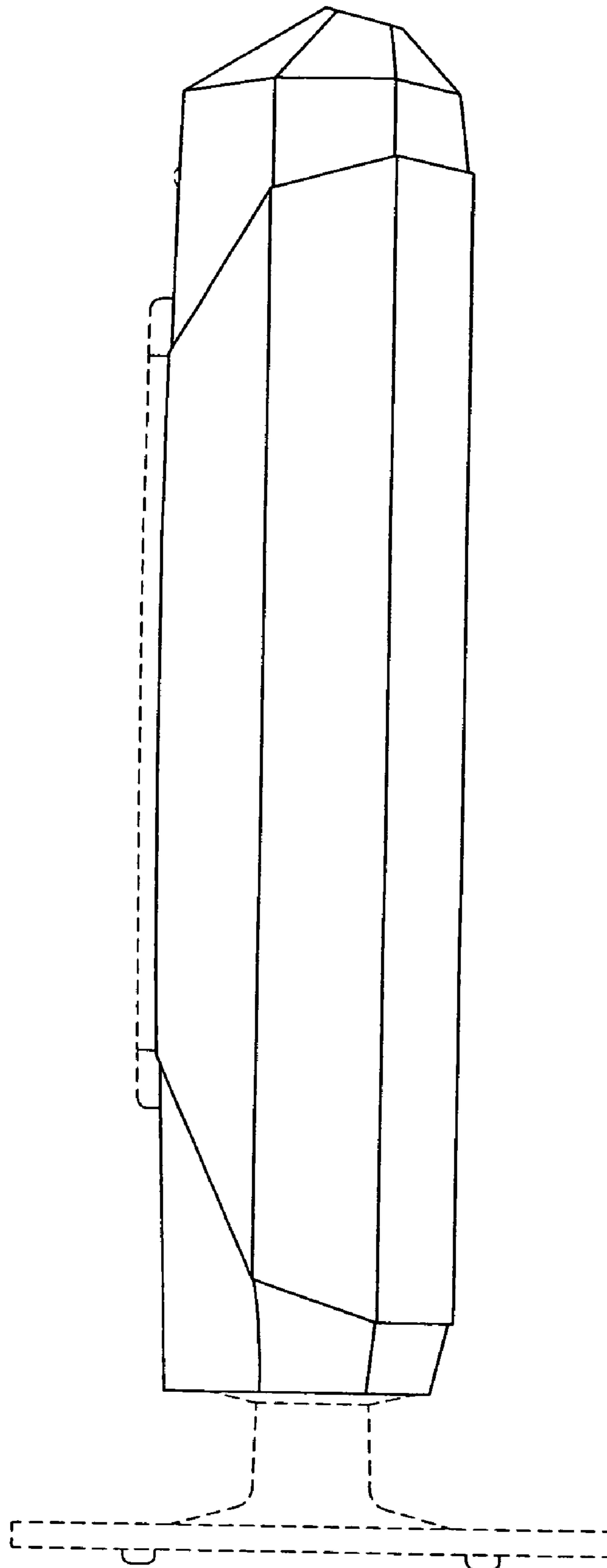

Fig. 6

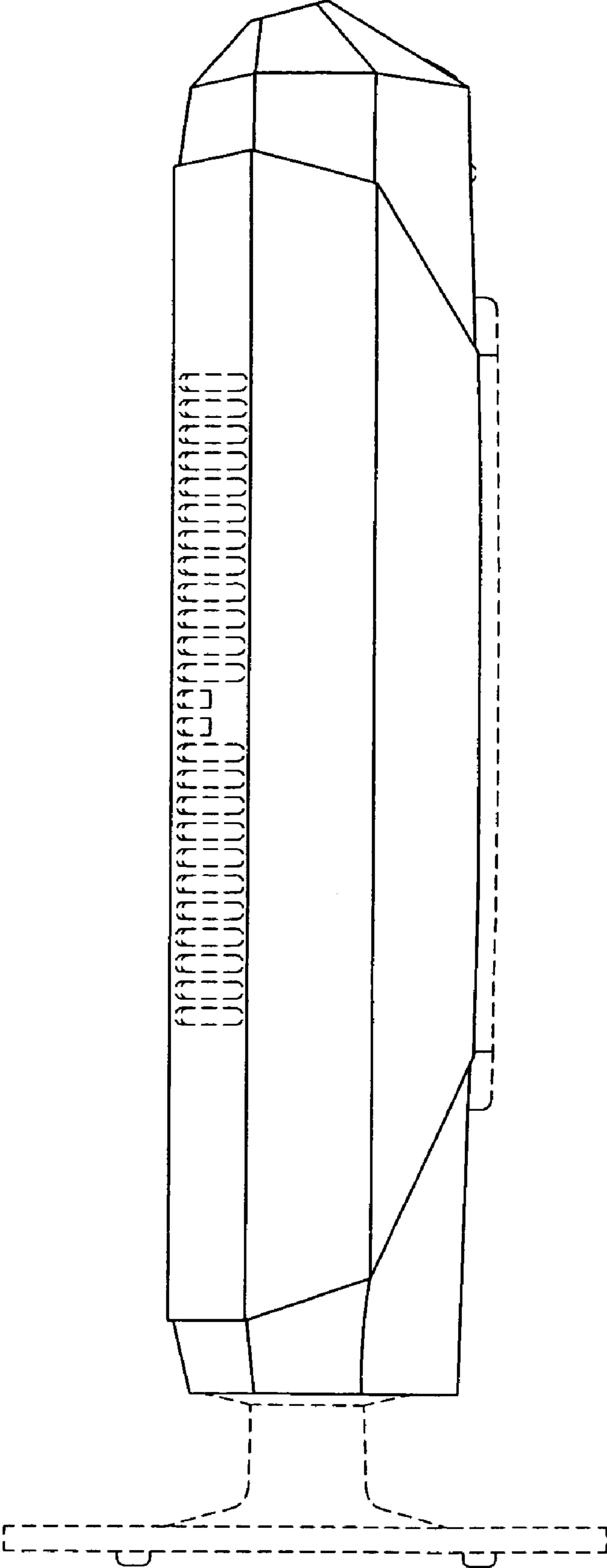

Fig. 7

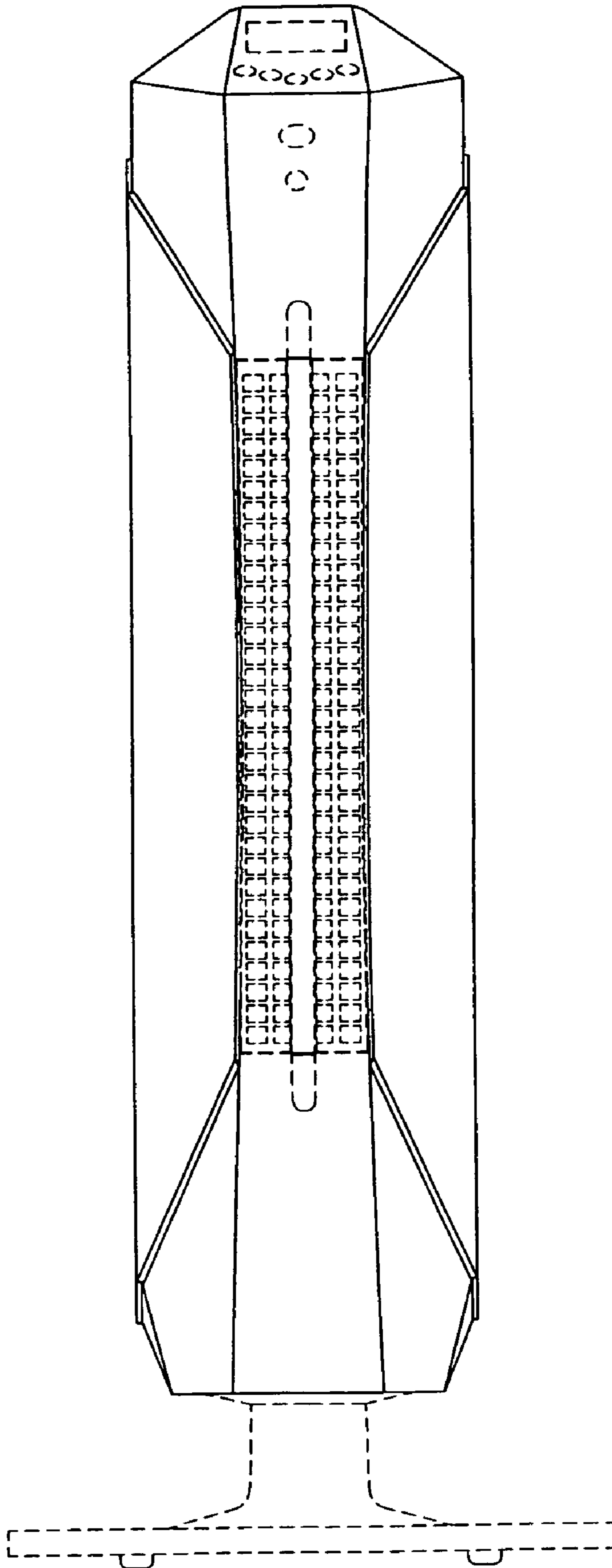

Fig. 8

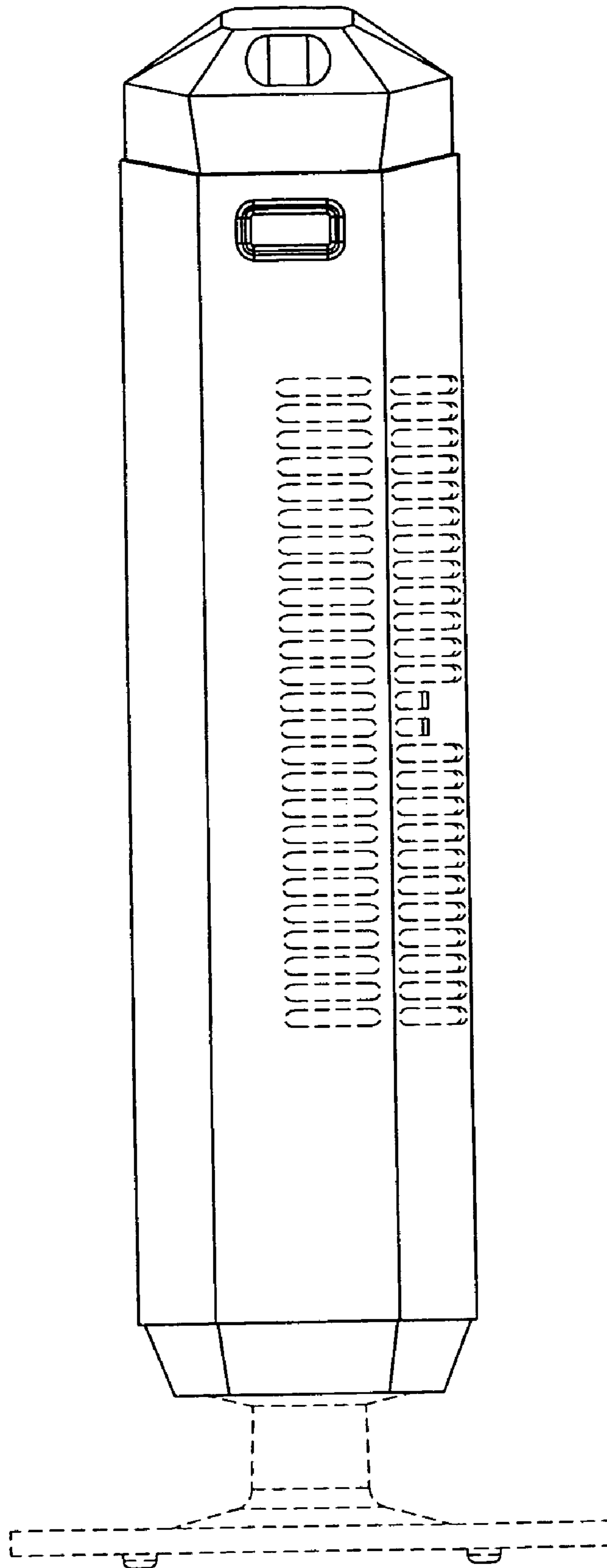

Fig. 9

