

US00D545931S

(12) **United States Design Patent**  
**Barez et al.**

(10) **Patent No.:** **US D545,931 S**  
(45) **Date of Patent:** **\*\* Jul. 3, 2007**

(54) **GOLF CLUB HEAD**

(75) Inventors: **Craig Kevin Barez**, Temecula, CA (US); **Todd P. Beach**, San Diego, CA (US); **Joseph Henry Hoffman**, Carlsbad, CA (US); **Robert Nunez**, San Pedro, CA (US); **Allan Capili Saliba**, Oceanside, CA (US); **Sean Toulon**, Vista, CA (US); **Thomas Olsavsky**, Oceanside, CA (US)

D513,051 S 12/2005 Barez et al.  
D514,185 S 1/2006 Barez et al.  
D516,652 S 3/2006 Barez et al.  
D518,129 S 3/2006 Poynor et al.  
D519,589 S 4/2006 Barez et al.  
D520,090 S \* 5/2006 Imamoto ..... D21/752  
D520,586 S \* 5/2006 Bingman ..... D21/759  
D521,091 S 5/2006 Mahaffey et al.  
D524,892 S \* 7/2006 Wilson et al. .... D21/759  
D527,064 S \* 8/2006 Breier et al. .... D21/752  
D533,611 S \* 12/2006 Mahaffey et al. .... D21/752

(73) Assignee: **Taylor Made Golf Company, Inc.**, Carlsbad, CA (US)

\* cited by examiner

(\*\*) Term: **14 Years**

*Primary Examiner*—Mitchell Siegel  
(74) *Attorney, Agent, or Firm*—Klarquist Sparkman, LLP

(21) Appl. No.: **29/268,283**

(57) **CLAIM**

(22) Filed: **Nov. 1, 2006**

We claim the ornamental design for a golf club head, as shown and described.

**Related U.S. Application Data**

(63) Continuation of application No. 29/265,285, filed on Aug. 28, 2006, which is a continuation of application No. 29/241,307, filed on Oct. 25, 2005.

**DESCRIPTION**

(51) **LOC (8) Cl.** ..... **21-02**

FIG. 1 is a perspective view of a golf club head, as viewed from the rear, bottom, and one side thereof, according to one embodiment.

(52) **U.S. Cl.** ..... **D21/759**

FIG. 2 is a front elevation view of the club head of FIG. 1.

(58) **Field of Classification Search** ..... D21/733, D21/752, 759; 473/324–331, 343–346  
See application file for complete search history.

FIG. 3 is a rear elevation view of the club head of FIG. 1.

FIG. 4 is a side elevation view of the heel of the club head of FIG. 1.

(56) **References Cited**

FIG. 5 is a side elevation view of the toe of the club head of FIG. 1.

**U.S. PATENT DOCUMENTS**

FIG. 6 is a top plan view of the club head of FIG. 1; and, FIG. 7 is a bottom plan view of the club head of FIG. 1.

D247,922 S 5/1978 Sheldon  
D469,141 S 1/2003 Poynor  
D479,867 S 9/2003 Saliba et al.  
D482,093 S 11/2003 Imamoto  
D499,158 S 11/2004 Imamoto  
D501,235 S 1/2005 Imamoto

The dashed lines in the drawings are for illustrative purposes only and form no part of the claimed design.

**1 Claim, 3 Drawing Sheets**

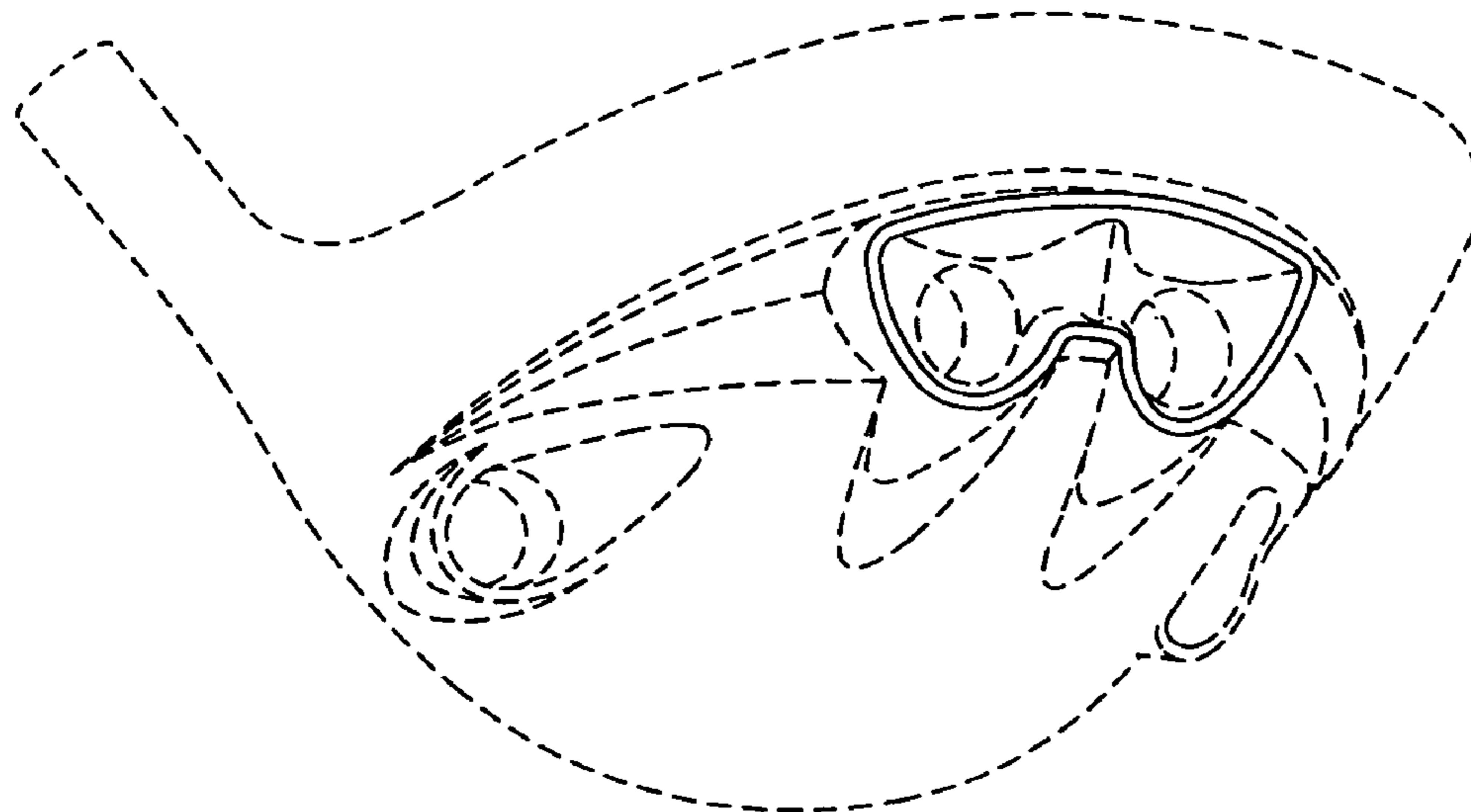

FIG. 1

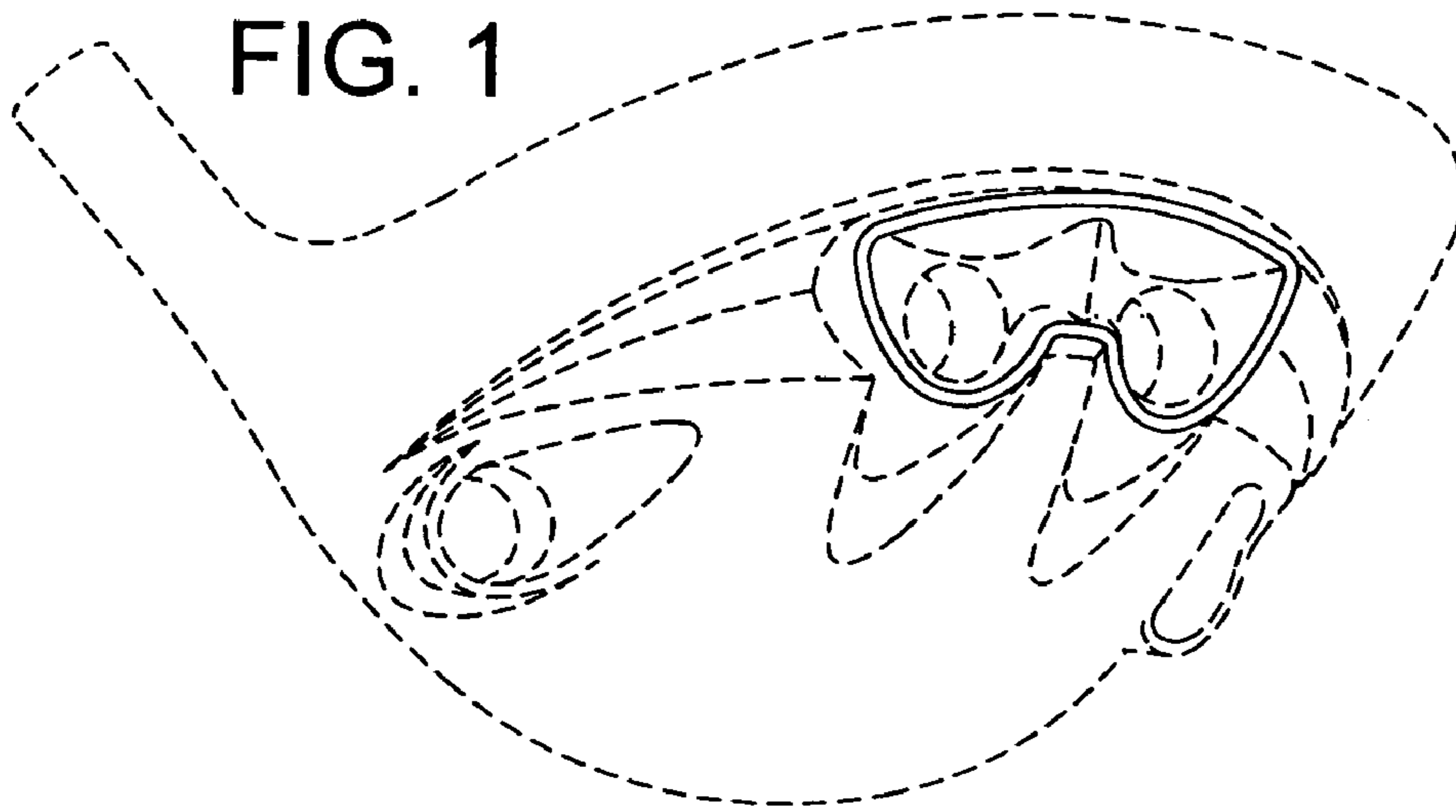

FIG. 2

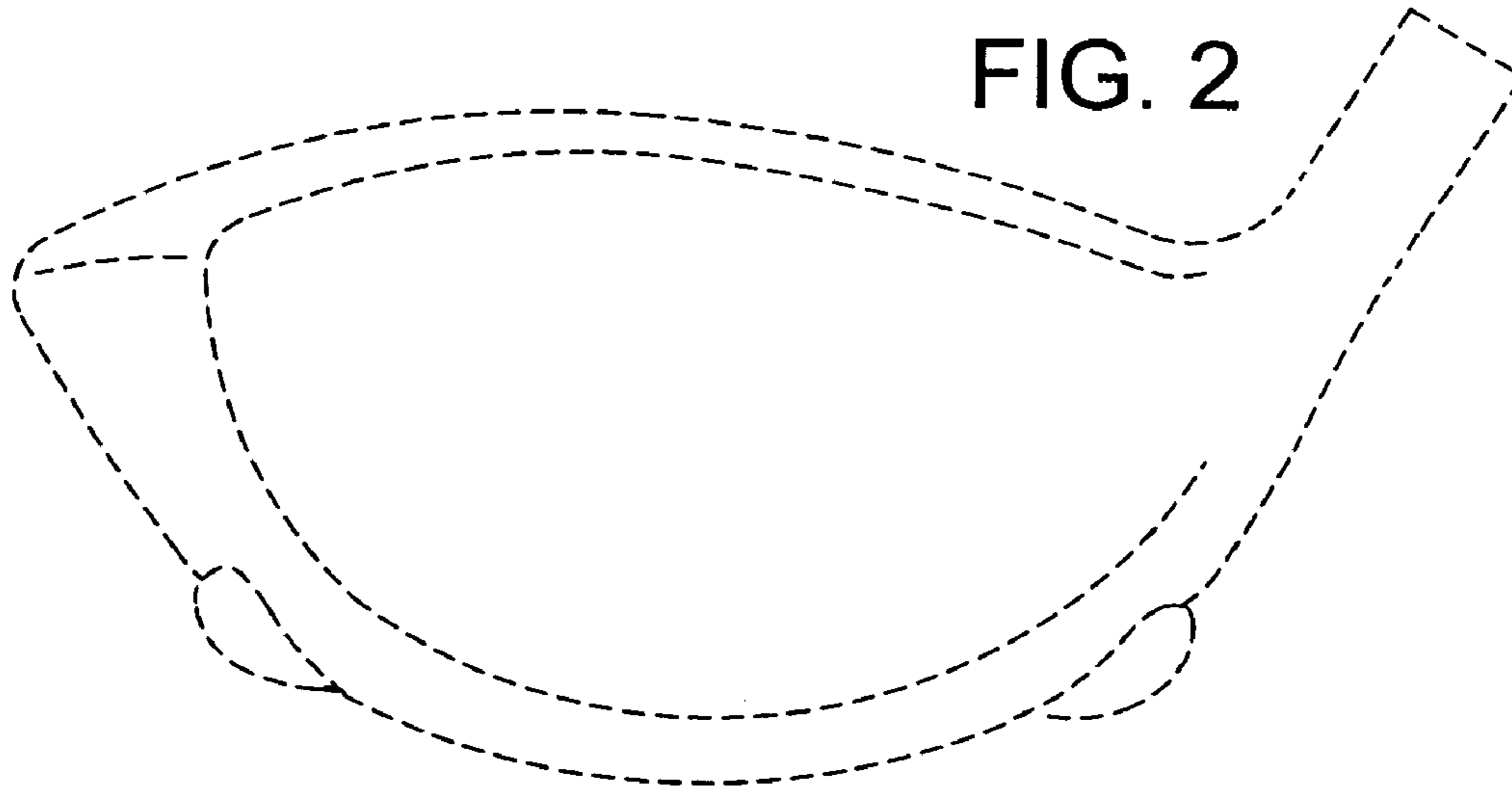
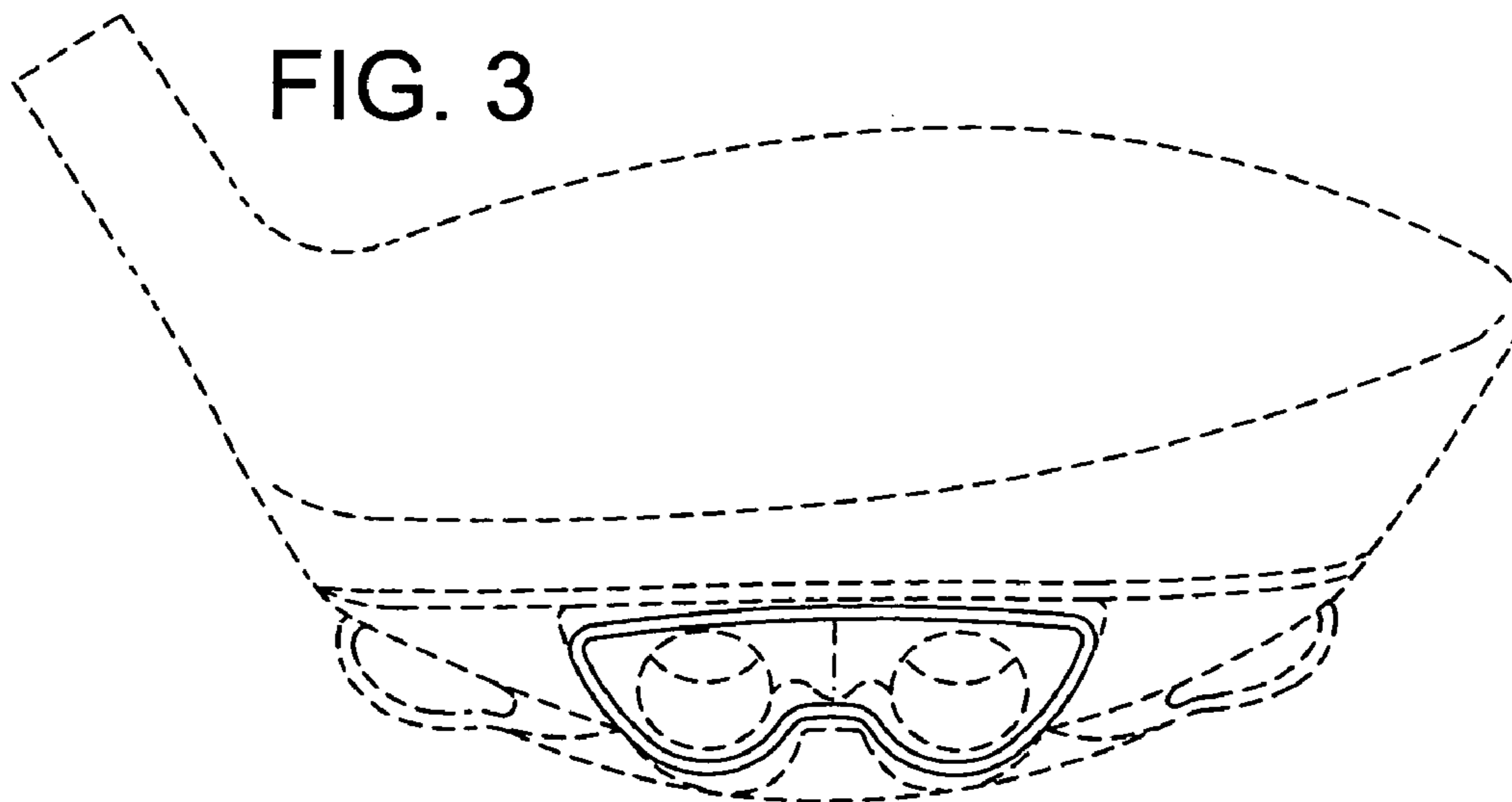
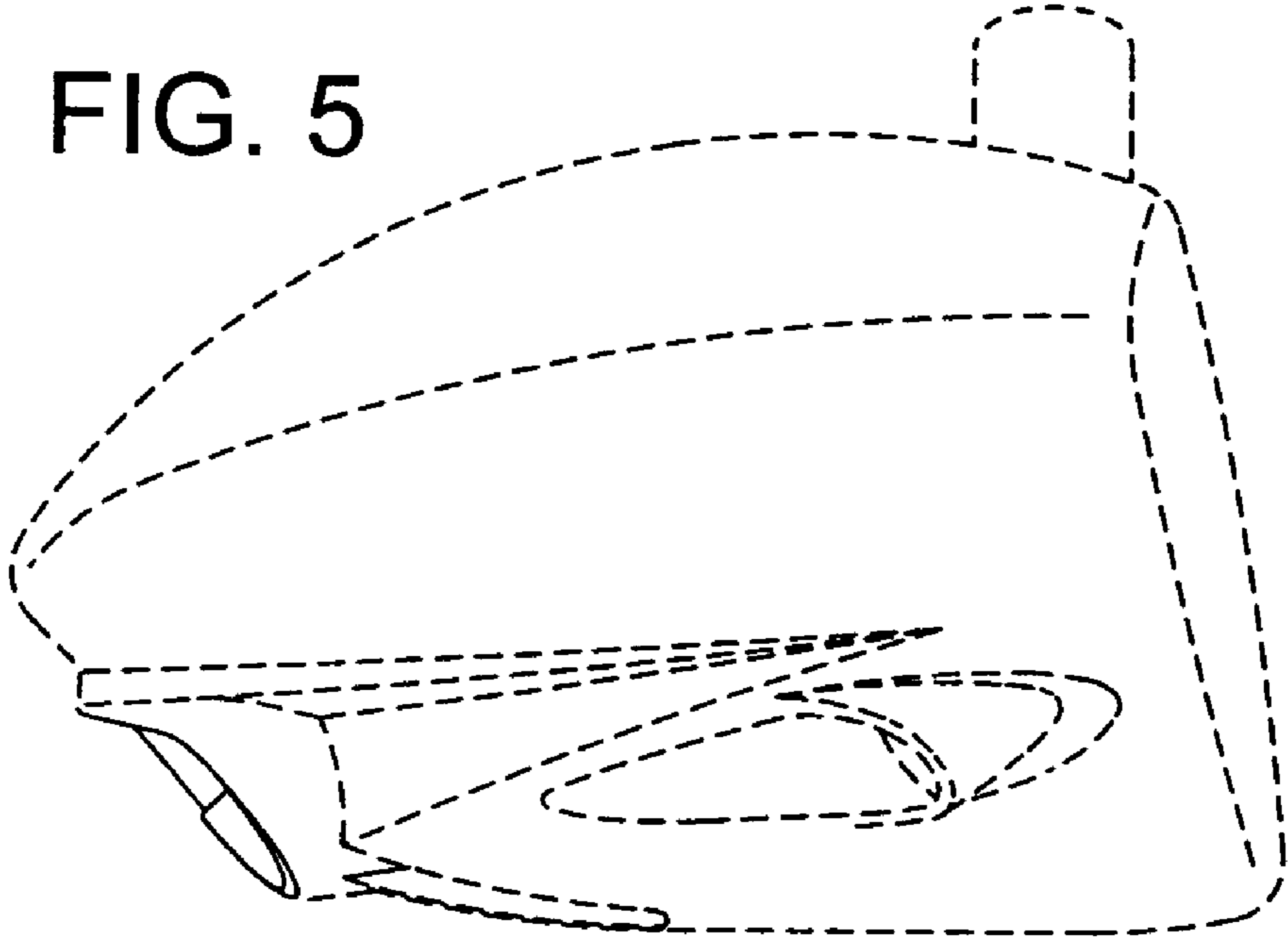
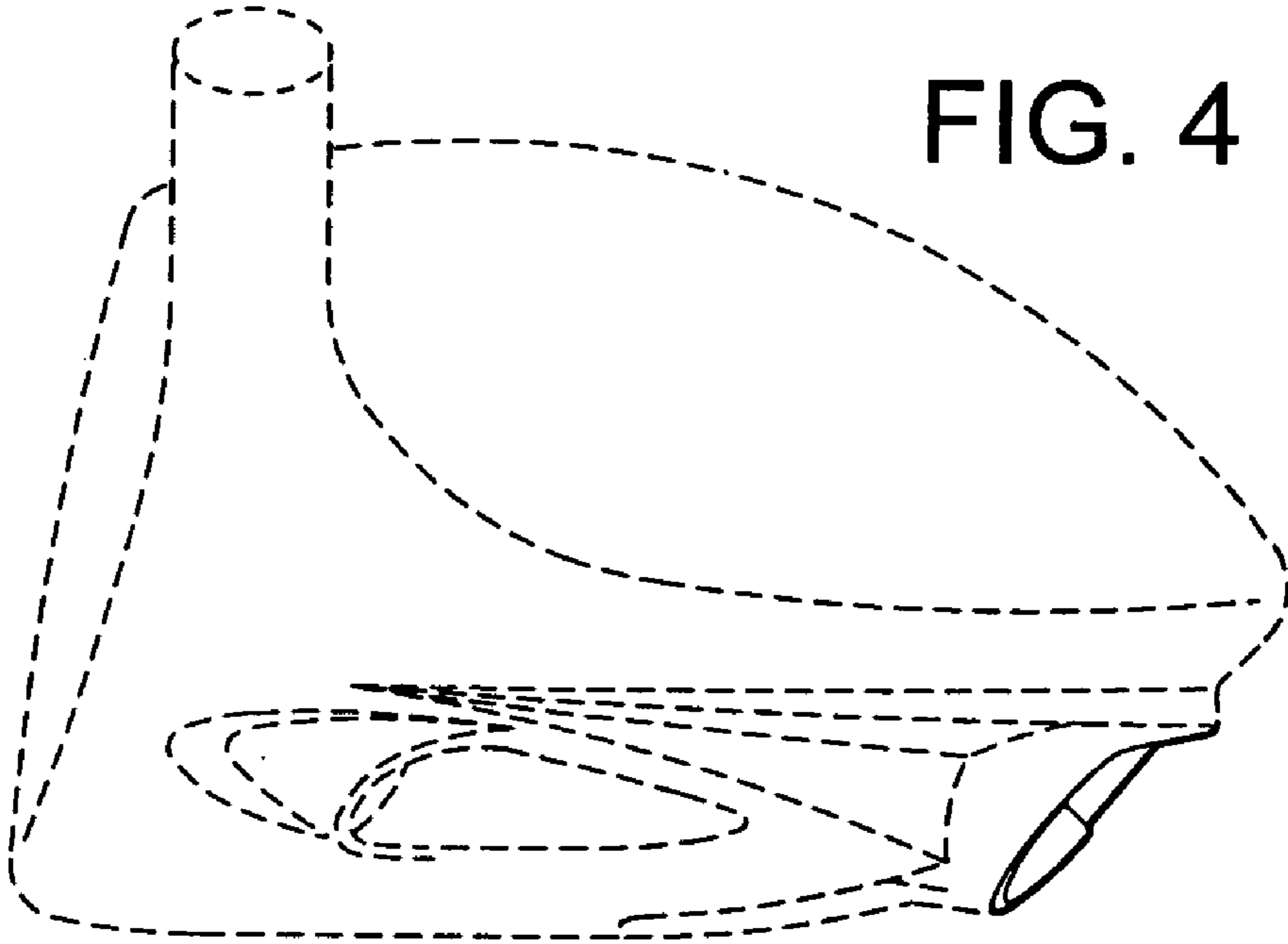

FIG. 3





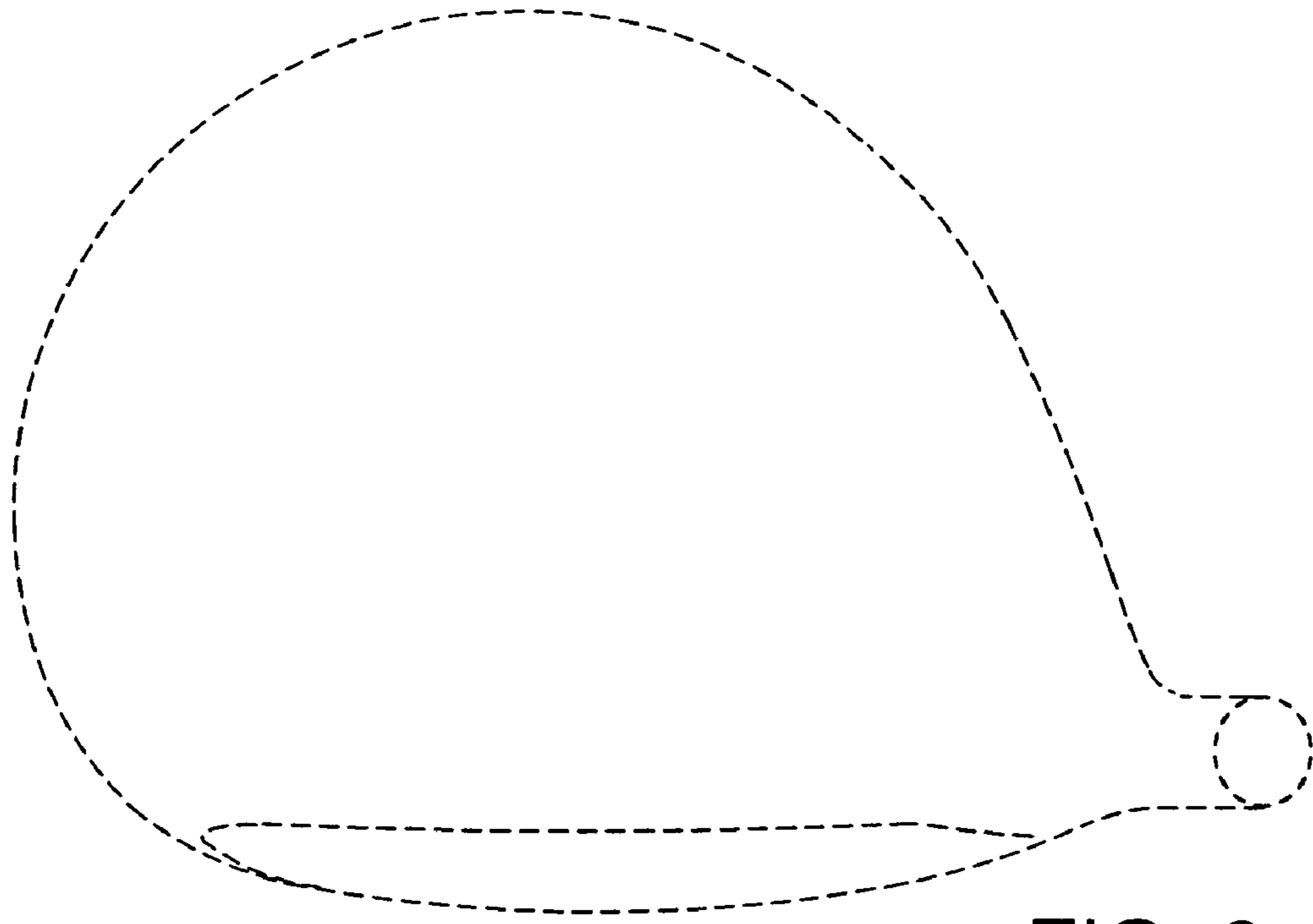

FIG. 6

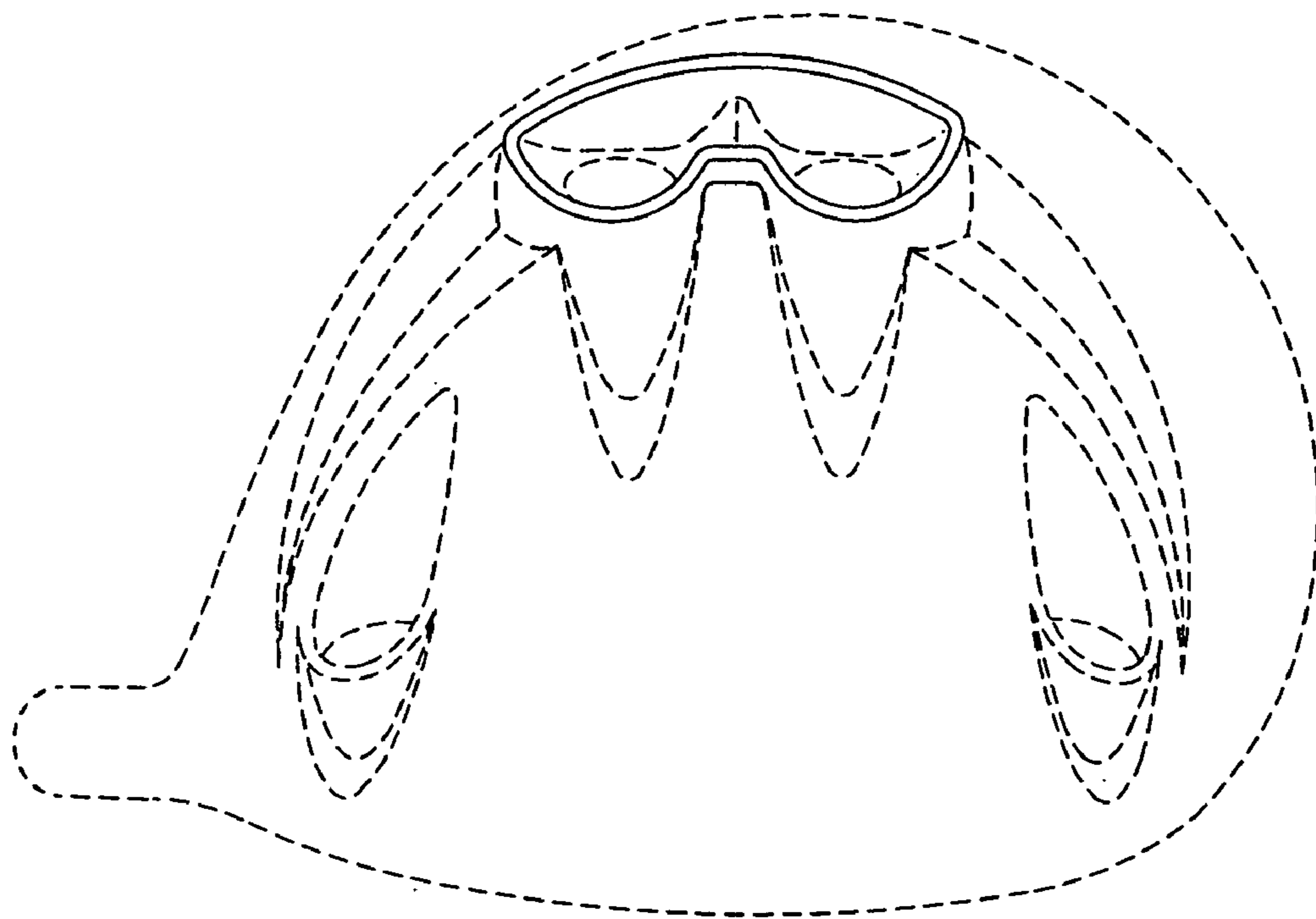

FIG. 7