



US00D545882S

(12) **United States Design Patent**
Sato

(10) **Patent No.:** **US D545,882 S**

(45) **Date of Patent:** **** Jul. 3, 2007**

(54) **POINT OF SALE TERMINAL**

(75) Inventor: **Junichi Sato**, Kawasaki (JP)

(73) Assignee: **NEC Infrontia Corporation**,
Kawasaki, Kanagawa (JP)

(**) Term: **14 Years**

(21) Appl. No.: **29/215,621**

(22) Filed: **Oct. 21, 2004**

(30) **Foreign Application Priority Data**

Apr. 28, 2004 (JP) 2004-013086

(51) **LOC (8) Cl.** **18-01**

(52) **U.S. Cl.** **D18/4.4**

(58) **Field of Classification Search** D18/3.1-3.3,
D18/4.1-4.6, 6-8, 11, 12, 12.1-12.3; D14/336,
D14/341-343, 371, 374-376, 384, 385, 387;
D21/324, 329; D99/28, 33, 43; 235/1 E,
235/2, 6, 7 R, 12, 33, 50 A, 50 B, 50 R,
235/51, 55 R, 379, 380, 386; 705/12, 15-18,
705/43

See application file for complete search history.

(56) **References Cited**

U.S. PATENT DOCUMENTS

D303,523 S * 9/1989 Shiozawa et al. D14/324
D345,966 S * 4/1994 Perez D18/4.5

D361,757 S * 8/1995 Mizusugi et al. D18/4.5
D385,903 S * 11/1997 Kim D18/4.4
D385,904 S * 11/1997 Kim D18/4.4
D424,602 S * 5/2000 Lin D18/4.3
D425,928 S * 5/2000 Jobetto et al. D18/4.3
D507,592 S * 7/2005 Mizusugi et al. D18/4.1
D508,565 S * 8/2005 Nephin et al. D14/336

* cited by examiner

Primary Examiner—Robert M. Spear

Assistant Examiner—Garth Rademaker

(74) *Attorney, Agent, or Firm*—Seyfarth Shaw LLP

(57) **CLAIM**

The ornamental design for the point of sale terminal, as shown and described.

DESCRIPTION

FIG. 1 is a front view of a point of sale terminal, showing my new design;

FIG. 2 is a rear view thereof;

FIG. 3 is a left side view thereof;

FIG. 4 is a right side view thereof;

FIG. 5 is a top plan view thereof;

FIG. 6 is a bottom plan view thereof; and,

FIG. 7 is a perspective view thereof.

1 Claim, 3 Drawing Sheets

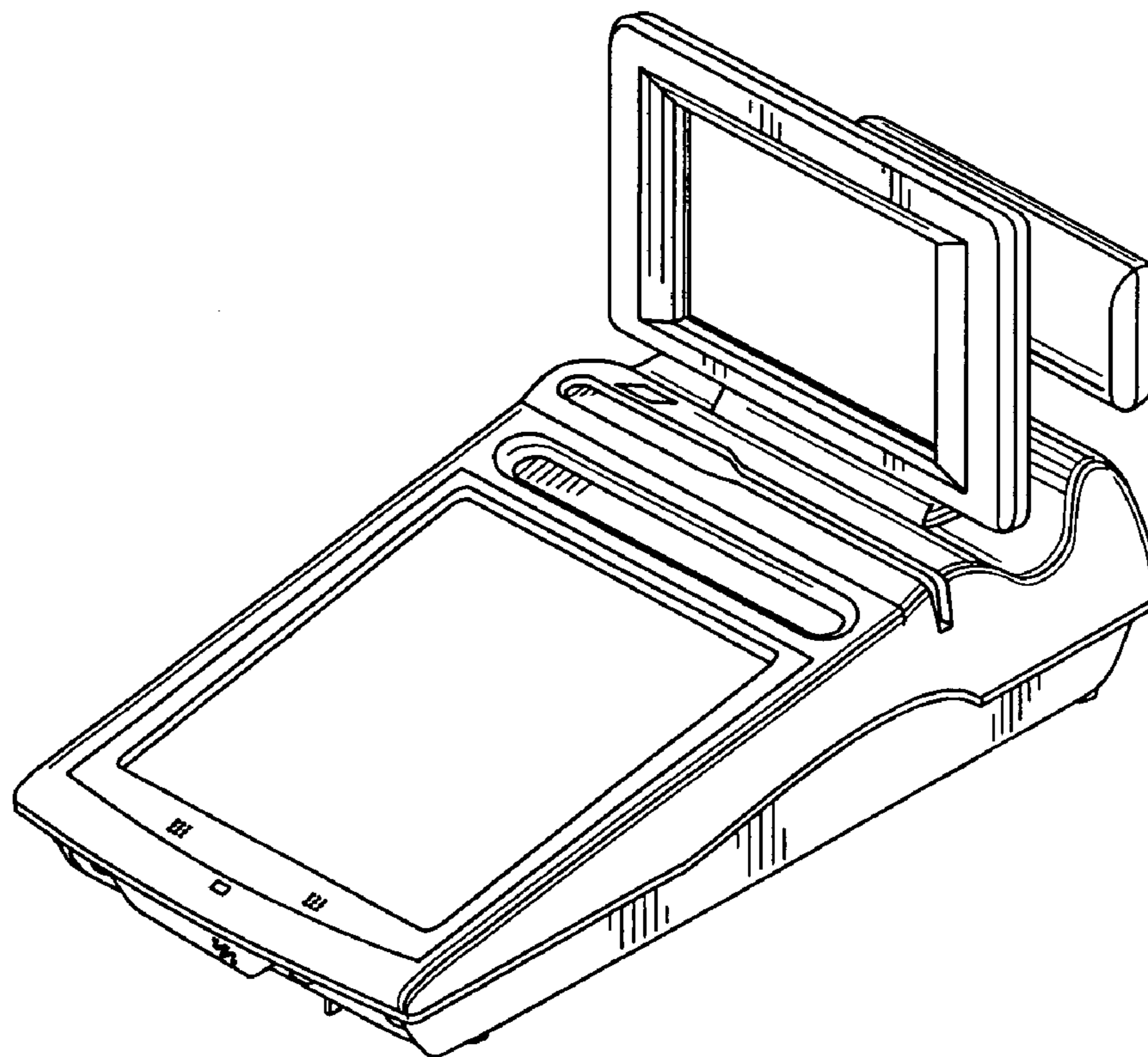

FIG. 1

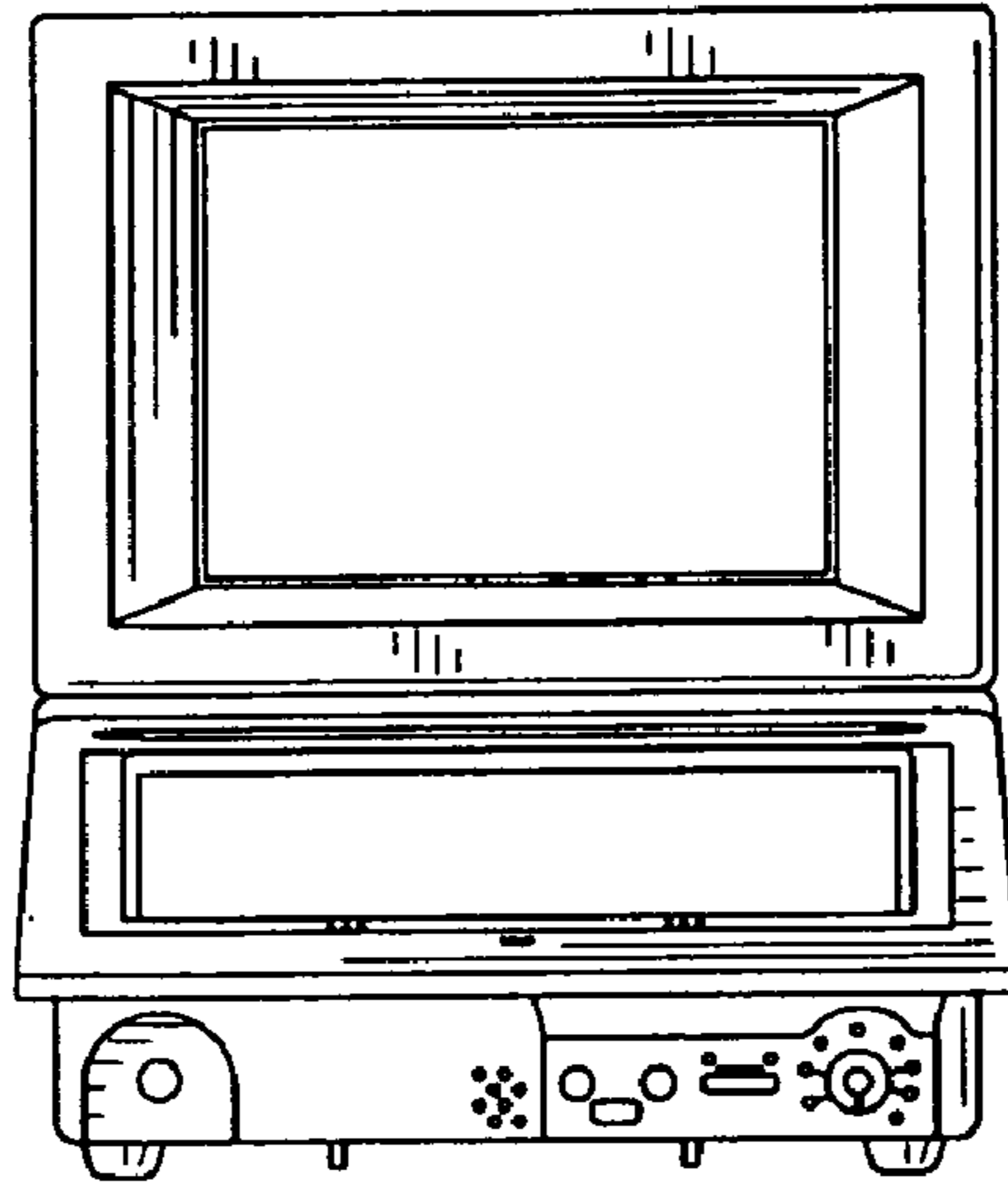

FIG. 2

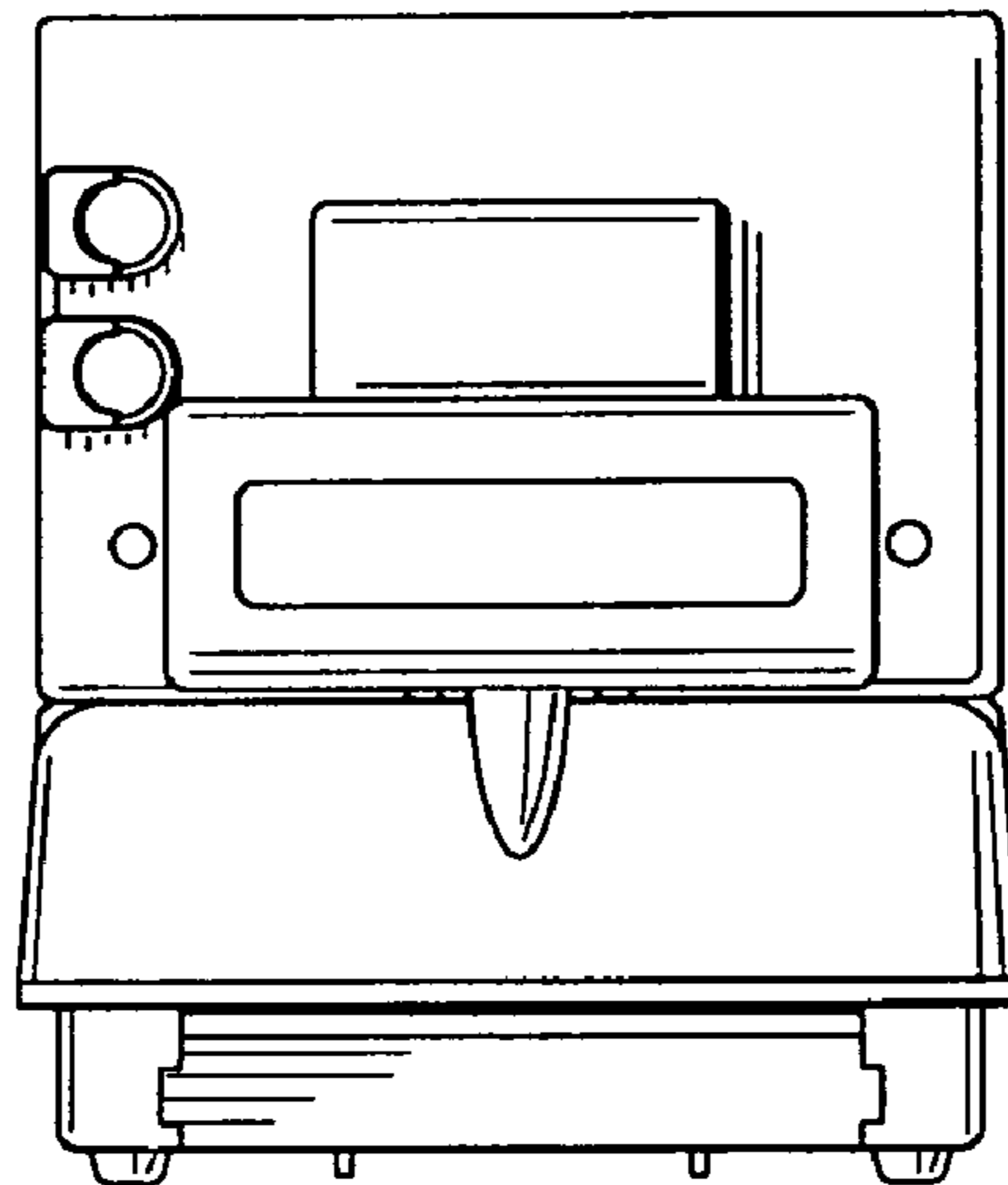

FIG. 3

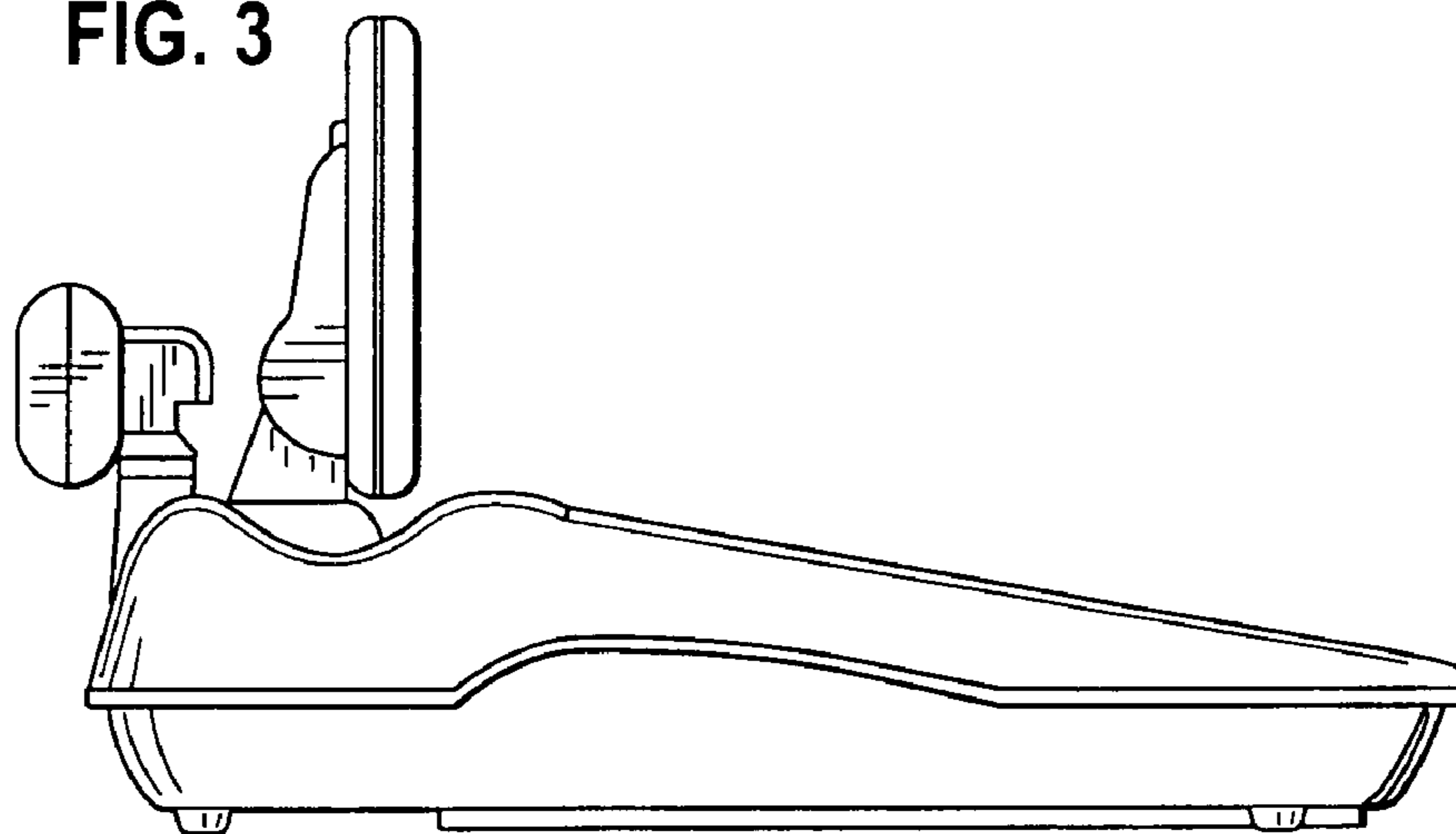

FIG. 4

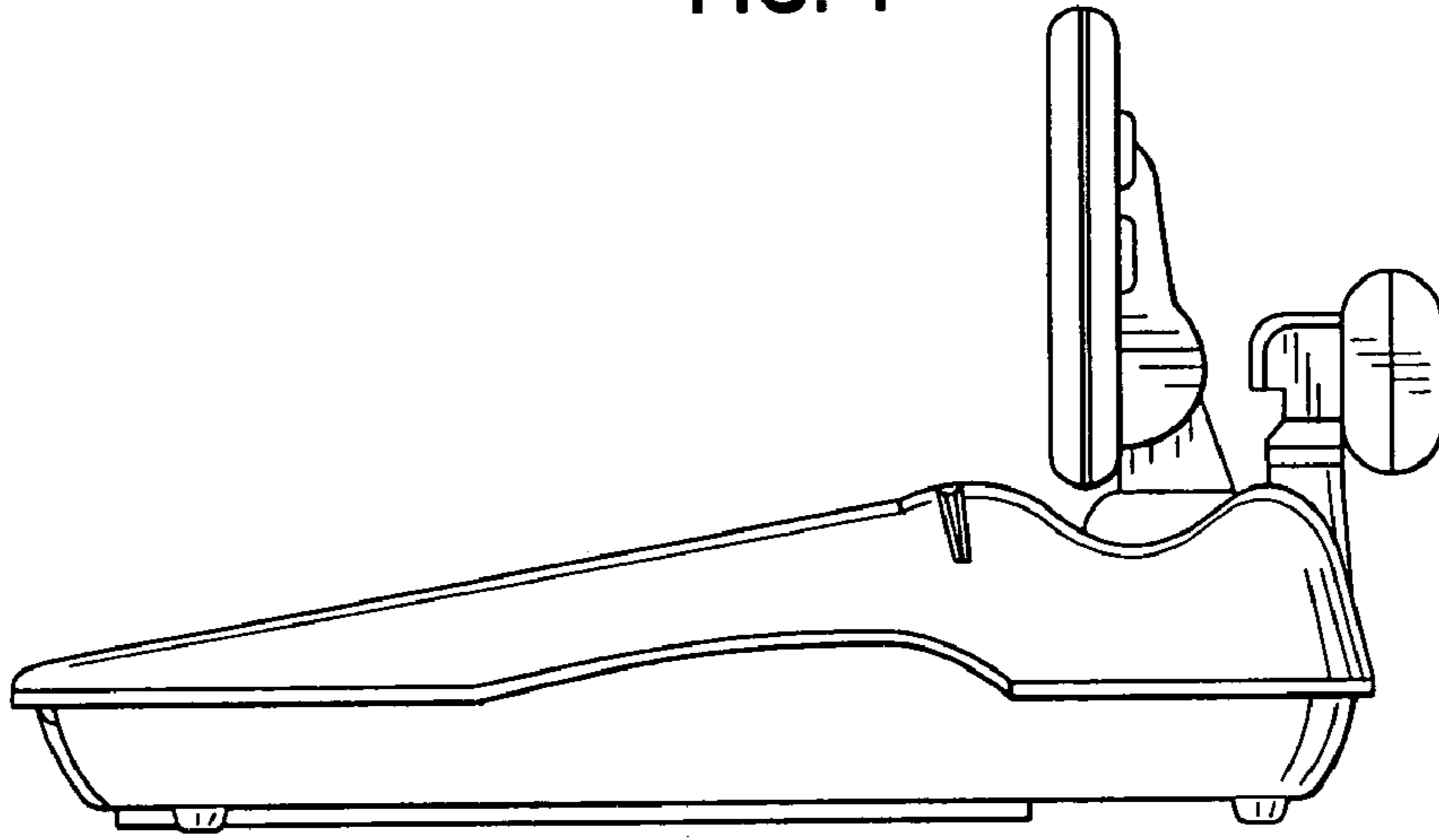

FIG. 5

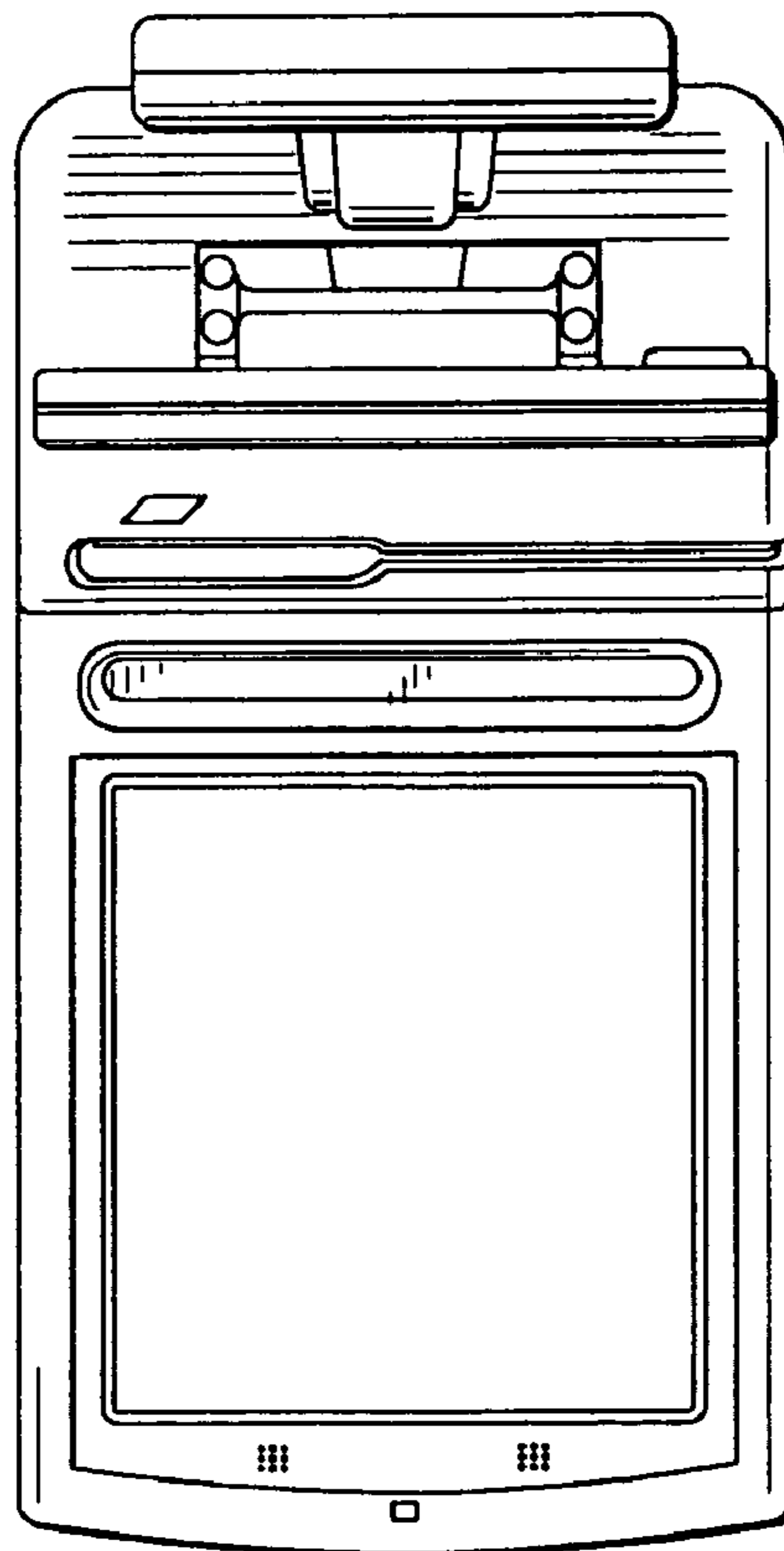

FIG. 6

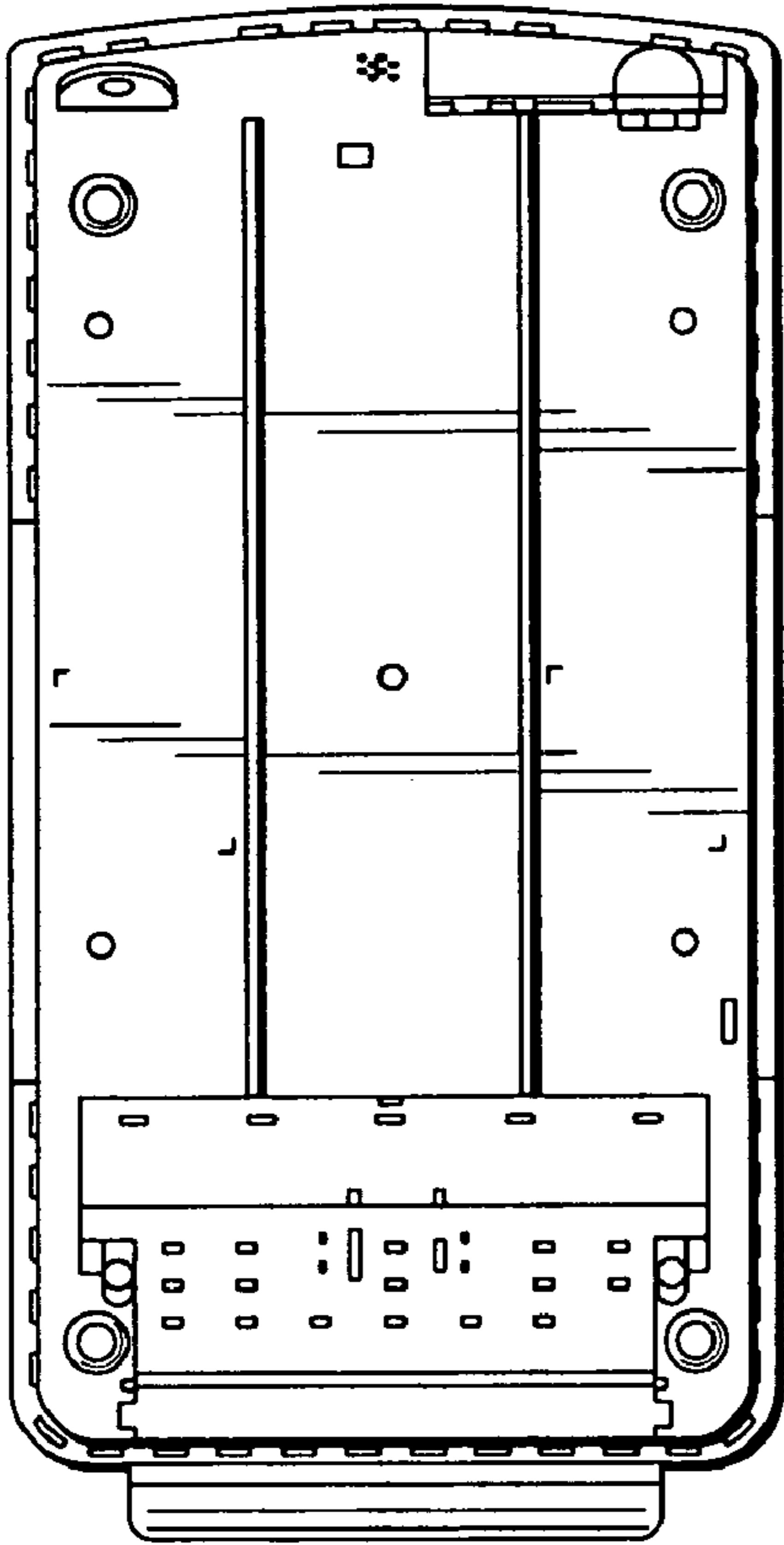

FIG. 7

