



US00D545778S

(12) **United States Design Patent**
Isshiki

(10) **Patent No.:** **US D545,778 S**
(45) **Date of Patent:** **** Jul. 3, 2007**

(54) **TELEVISION SET**
(75) Inventor: **Masao Isshiki**, Kawasaki (JP)
(73) Assignee: **Kabushiki Kaisha Toshiba** (JP)
(**) Term: **14 Years**

JP D1183276 8/2003
JP D1184815 9/2003
JP D1213666 8/2004
JP D1213667 8/2004
JP D1234221 3/2005

(21) Appl. No.: **29/259,880**
(22) Filed: **May 18, 2006**

OTHER PUBLICATIONS

B&H Summer Catalog, pp. 119-123, dated Jun. 2004.

* cited by examiner

(30) **Foreign Application Priority Data**
Apr. 13, 2006 (JP) 2006-009636

Primary Examiner—Raphael Barkai

(74) *Attorney, Agent, or Firm*—Banner & Witcoff, Ltd.

(51) **LOC (8) Cl.** **14-03**
(52) **U.S. Cl.** **D14/126**
(58) **Field of Classification Search** D14/125-134,
D14/239, 371, 136, 374-377; 312/7.2; 348/836,
348/838, 180, 184, 325, 739; 341/12; 248/917-924,
248/465; 345/104, 133, 156, 168, 87, 173;
720/600, 655, 605, 669; 369/99, 197; 455/344-347
See application file for complete search history.

(57) **CLAIM**

The ornamental design for a television set, as shown and described.

(56) **References Cited**

DESCRIPTION

U.S. PATENT DOCUMENTS

FIG. 1 is a front, top and right side perspective view of a television set, showing my new design;
FIG. 2 is a front elevational view thereof;
FIG. 3 is a rear elevational view thereof;
FIG. 4 is a top plan view thereof;
FIG. 5 is a bottom plan view thereof;
FIG. 6 is a left side elevational view thereof; and,
FIG. 7 is a right side elevational view thereof.

D471,549 S * 3/2003 Tsuji D14/375
D483,020 S * 12/2003 Nagao et al. D14/126
D497,352 S 10/2004 Asanuma et al.
D499,730 S * 12/2004 Yamashiro D14/375
D503,158 S 3/2005 Asanuma et al.

FOREIGN PATENT DOCUMENTS

JP D1127085 11/2001

1 Claim, 4 Drawing Sheets

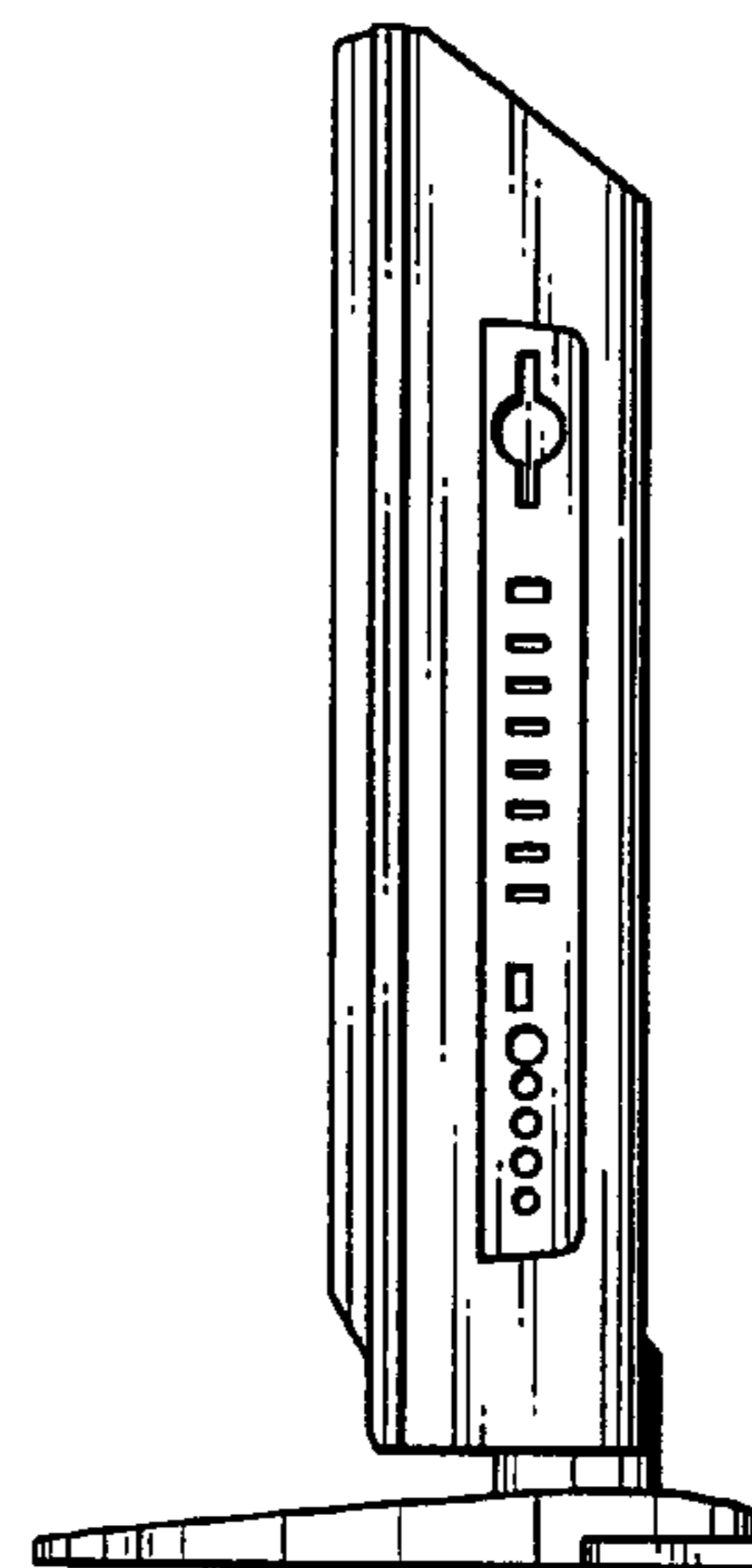
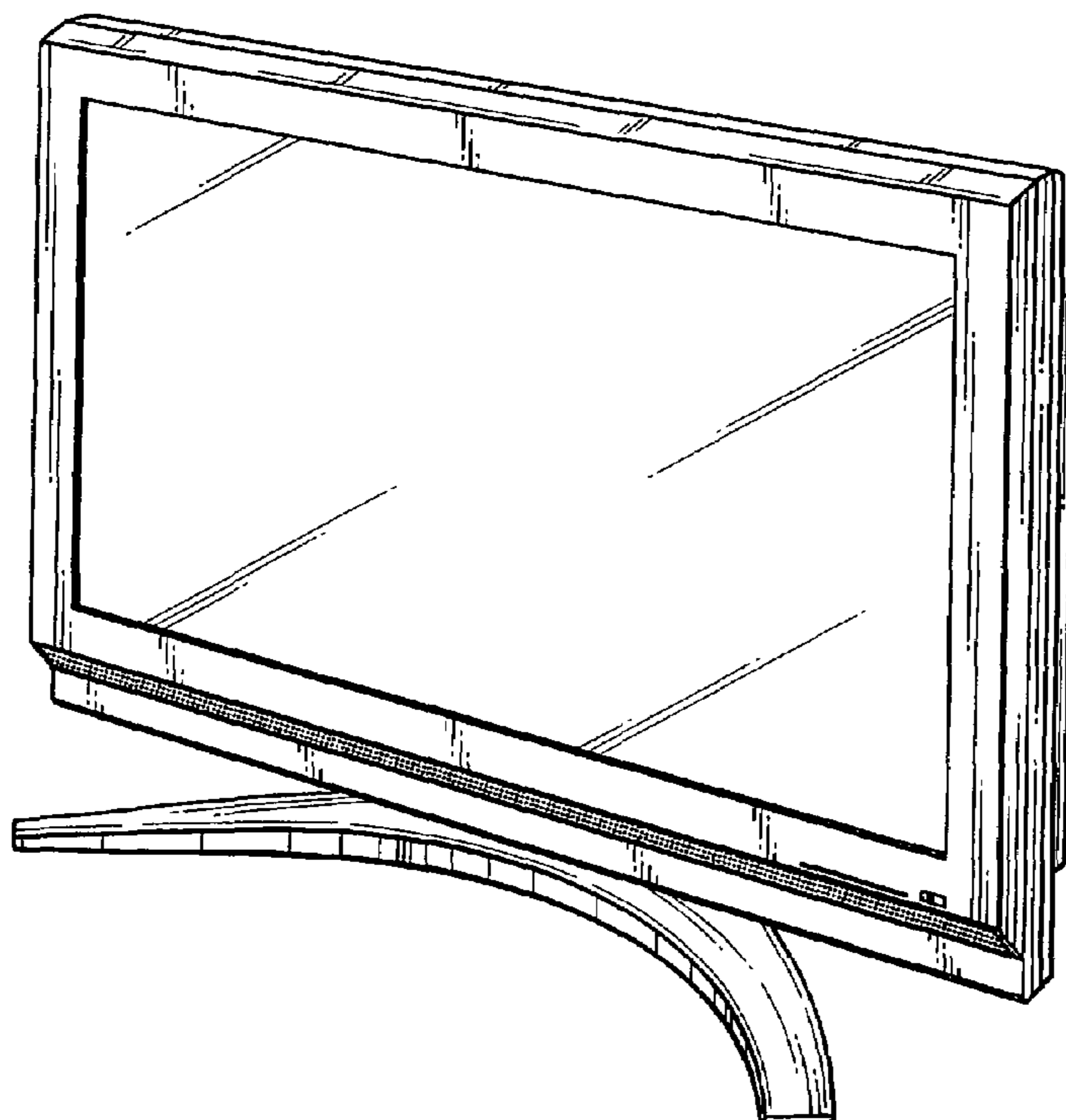

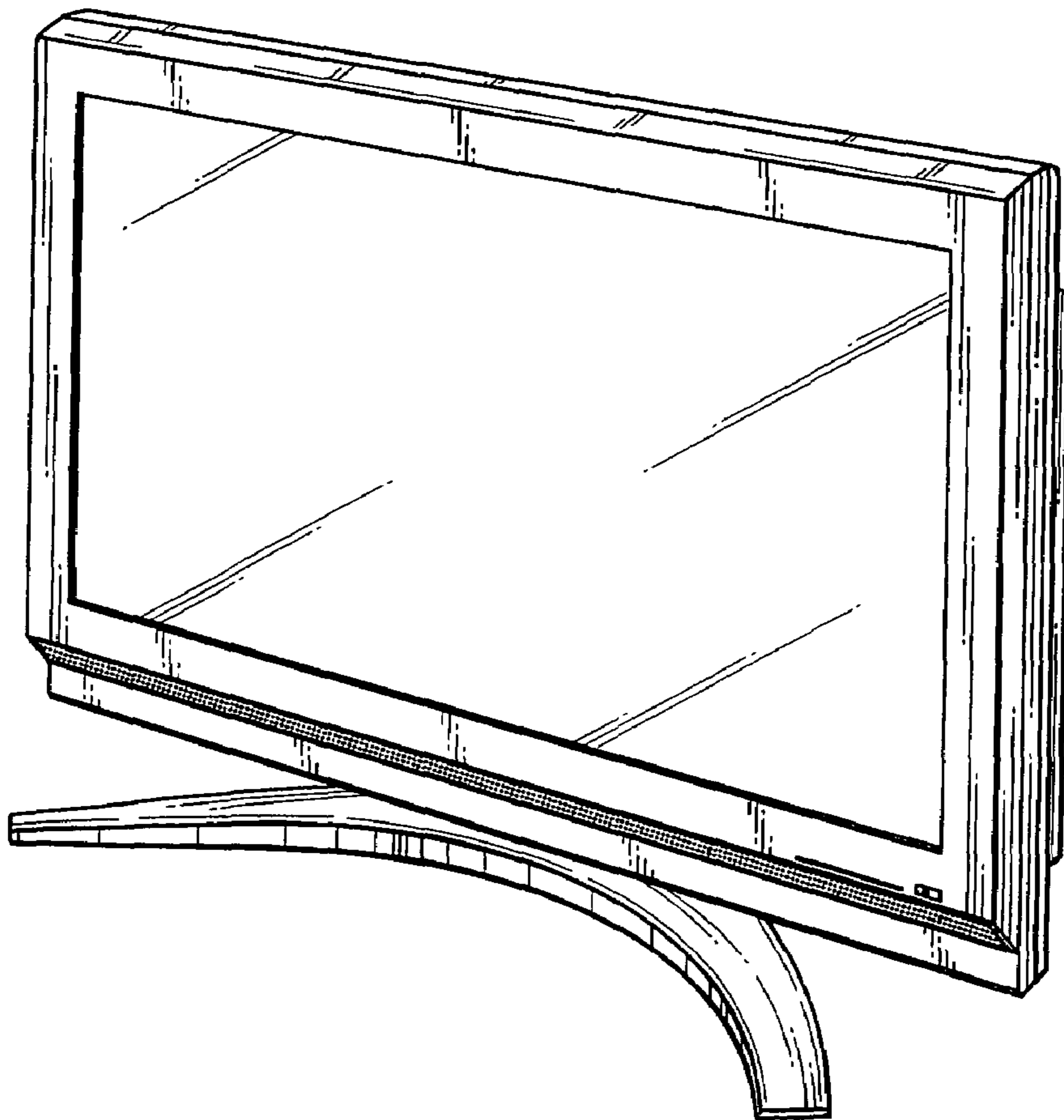

FIG.1

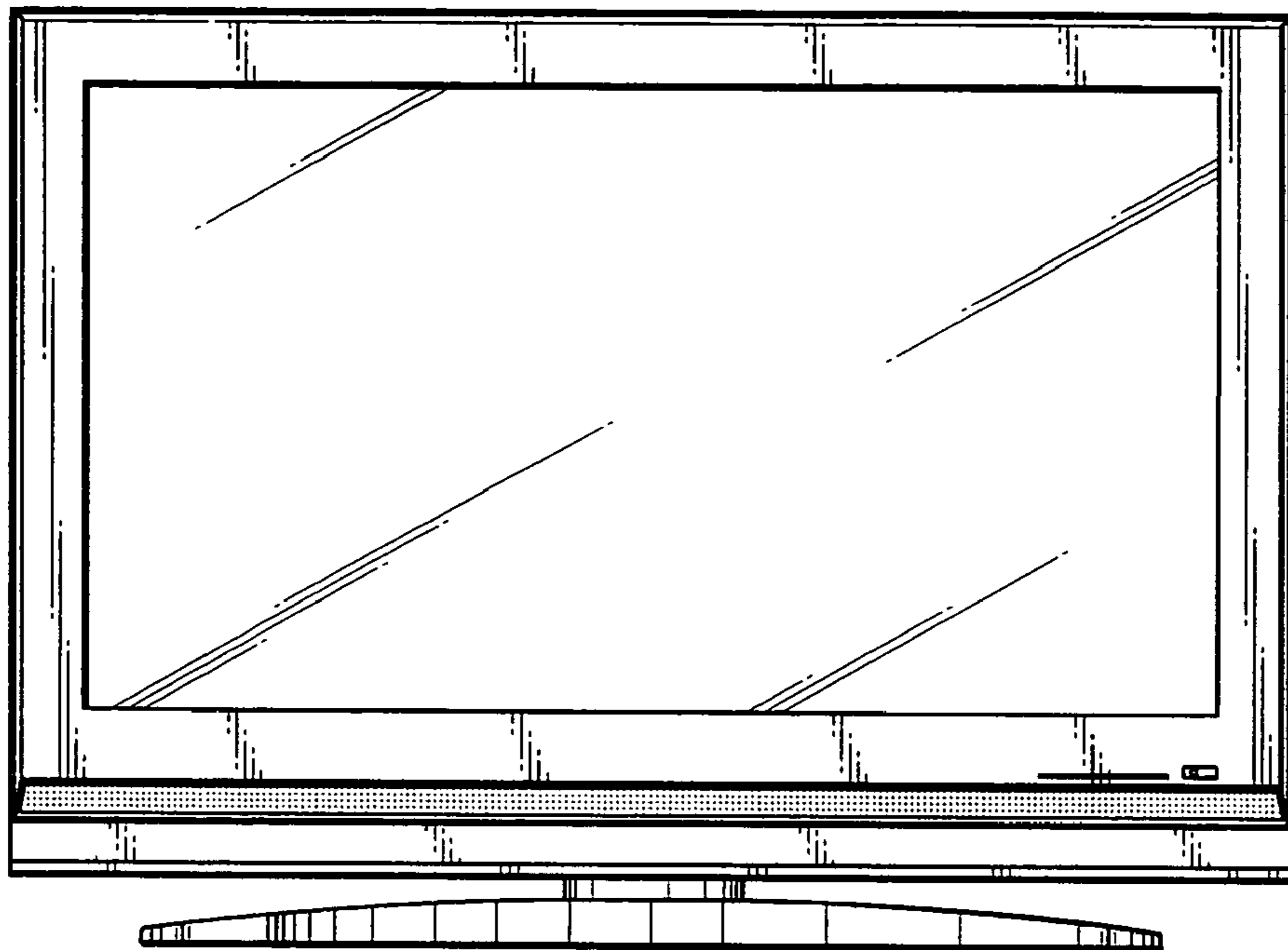

FIG. 2

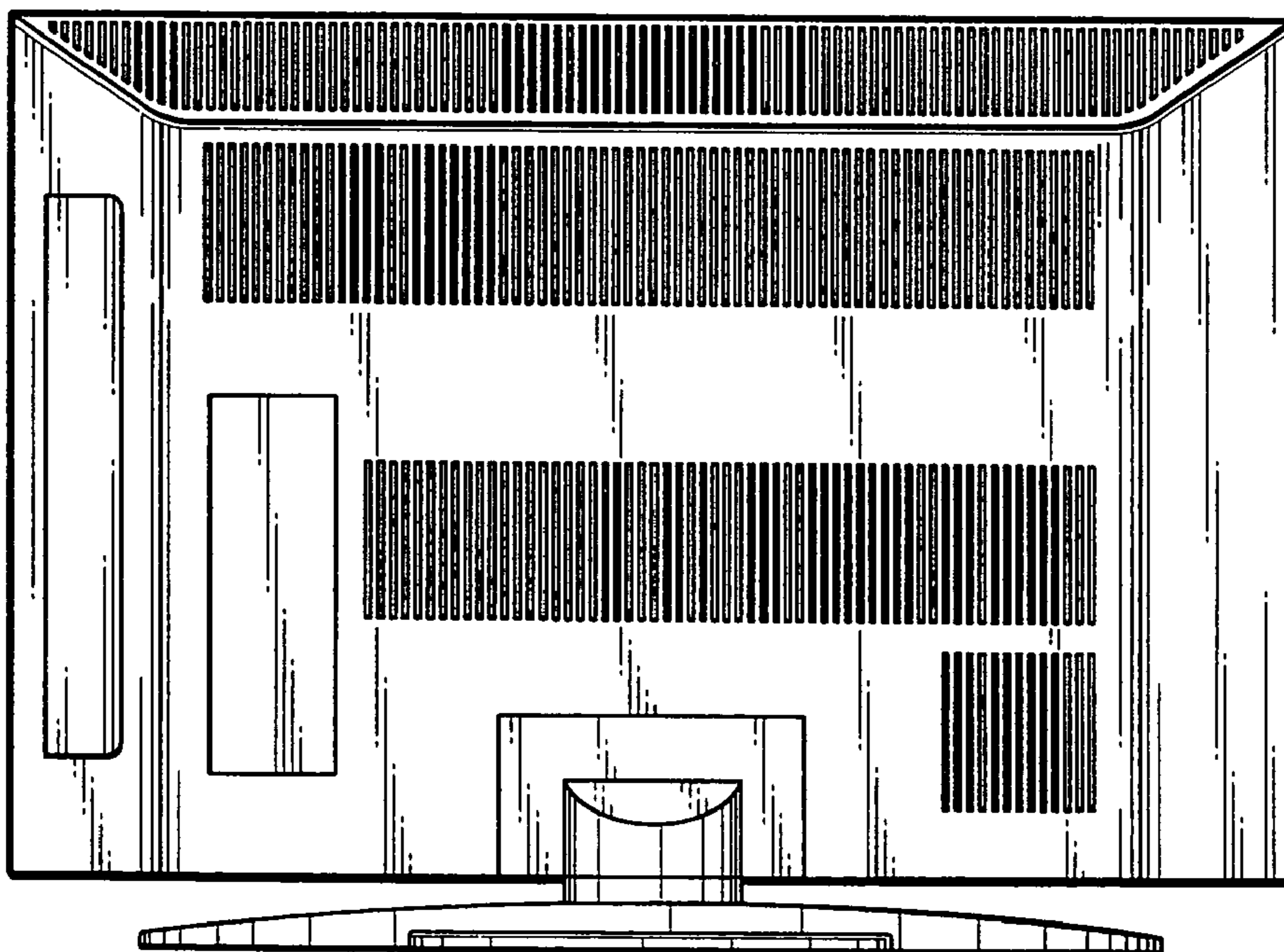

FIG. 3

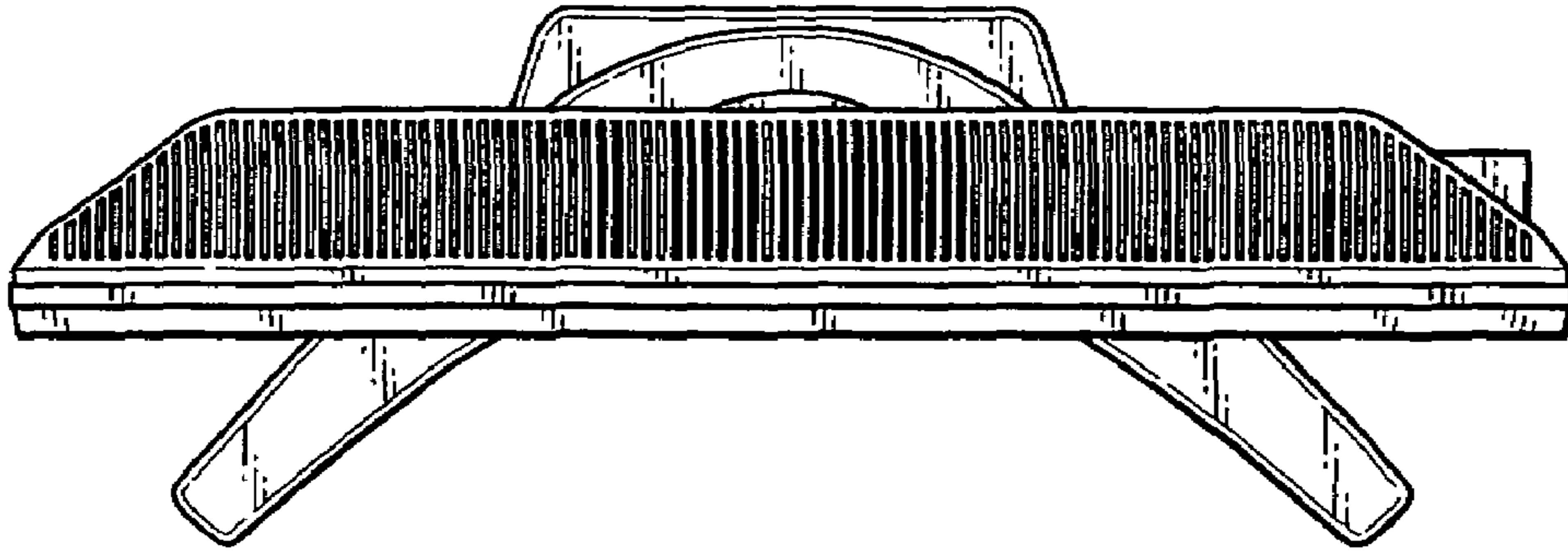

FIG. 4

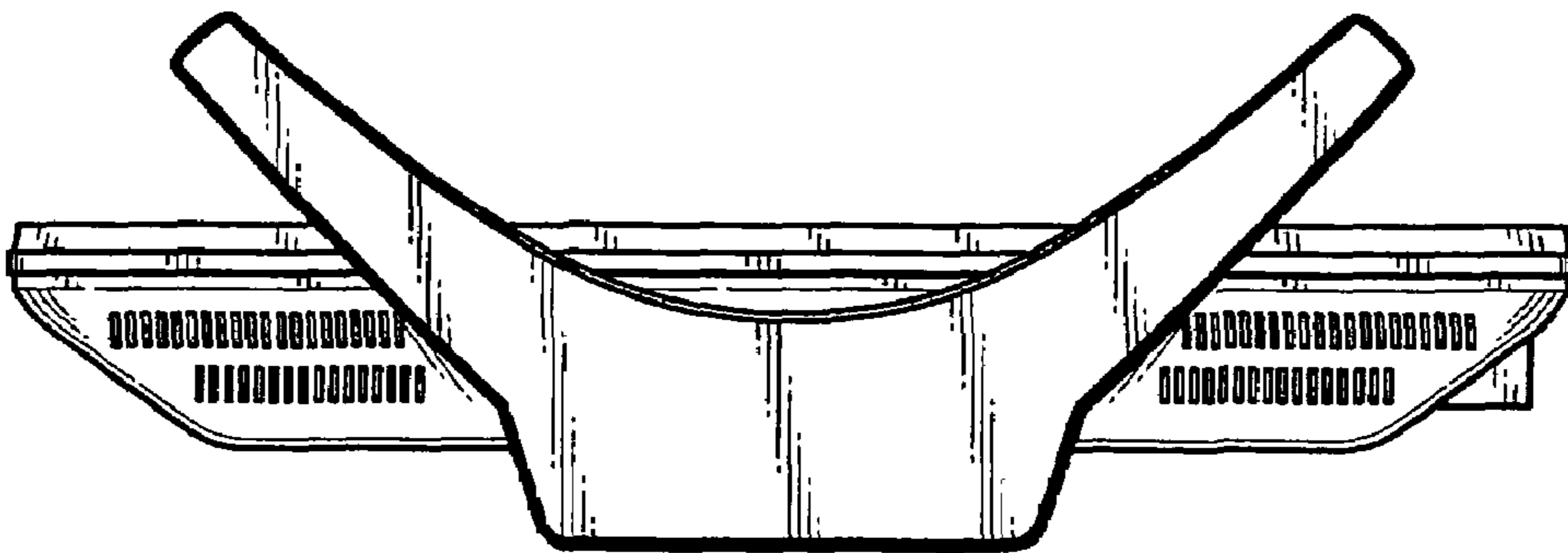

FIG. 5

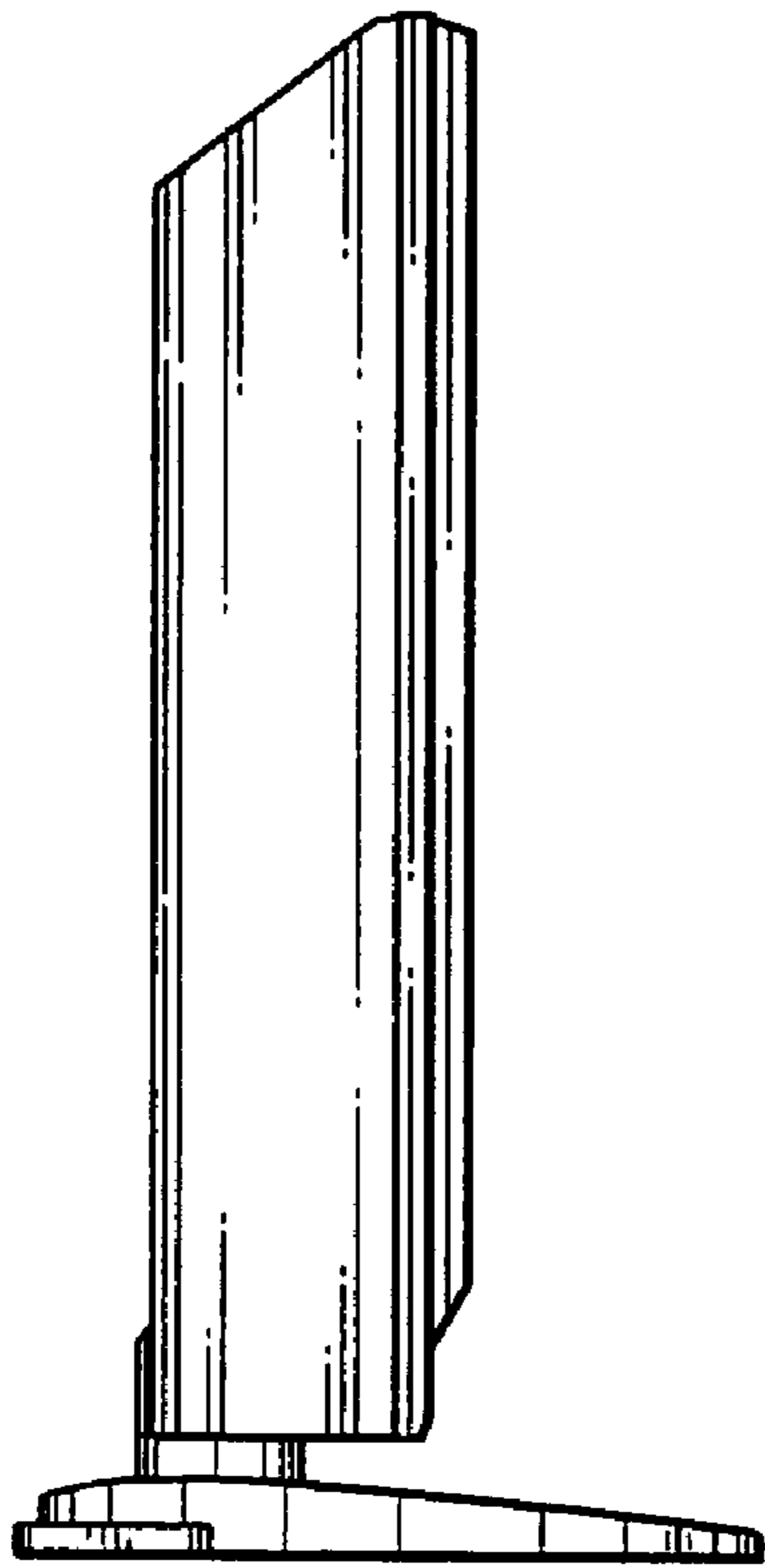

FIG. 6

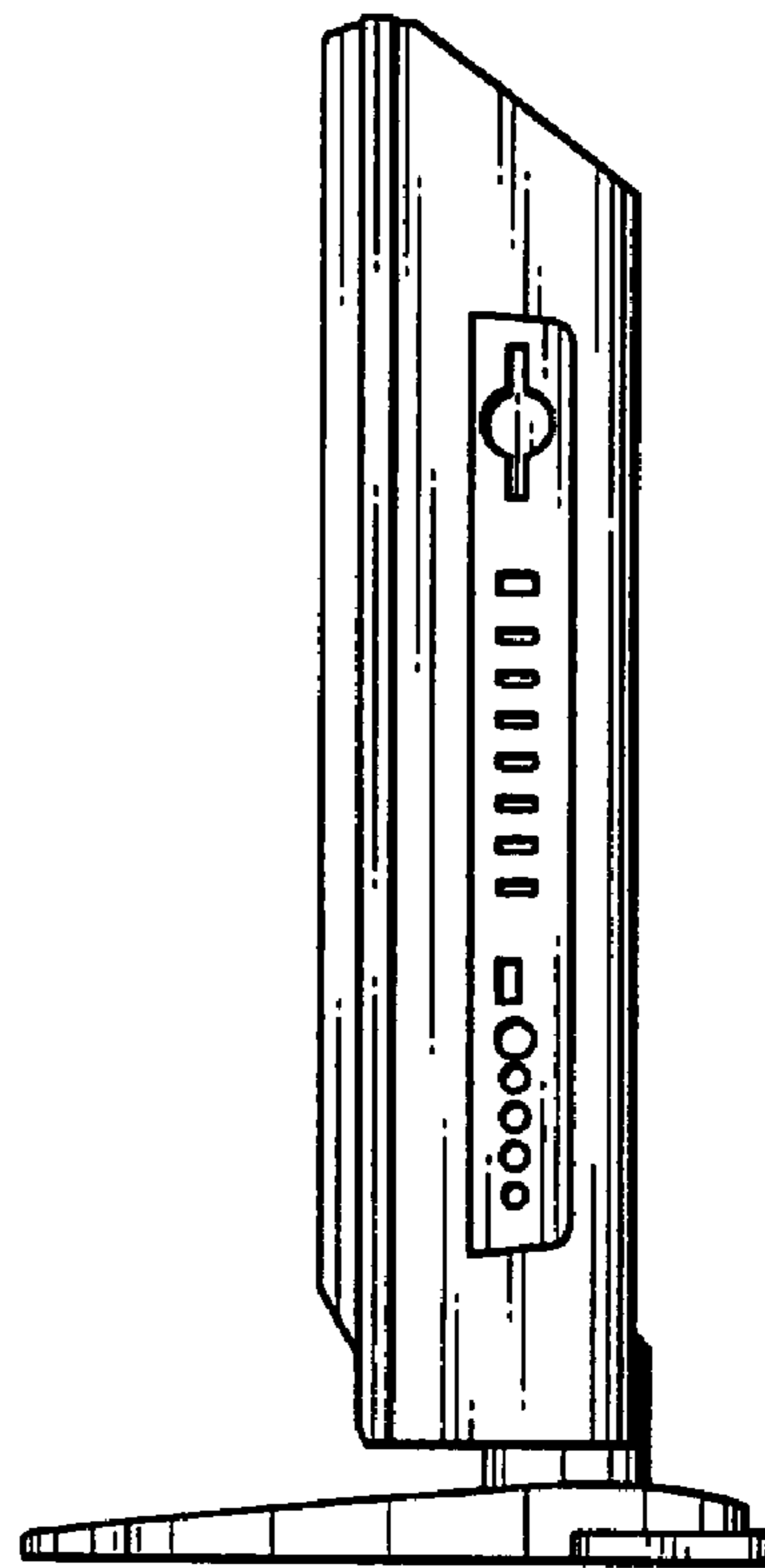

FIG. 7