

US00D545763S

(12) **United States Design Patent**  
**Tufano, Jr.**

(10) **Patent No.:** **US D545,763 S**

(45) **Date of Patent:** **\*\* Jul. 3, 2007**

(54) **LATCHING SINGLE CAM CONNECTOR**

(75) Inventor: **Anthony Tufano, Jr.**, Seaford, NY  
(US)

(73) Assignee: **Leviton Manufacturing Co., Inc.**,  
Little Neck, NY (US)

(\*\*) Term: **14 Years**

(21) Appl. No.: **29/247,028**

(22) Filed: **May 24, 2006**

**Related U.S. Application Data**

(62) Division of application No. 29/216,285, filed on Nov.  
1, 2004, now Pat. No. Des. 521,931.

(51) **LOC (8) Cl.** ..... **13-03**

(52) **U.S. Cl.** ..... **D13/133**

(58) **Field of Classification Search** ..... D13/133,  
D13/146, 147, 154, 184, 199; 439/314-322,  
439/680, 752

See application file for complete search history.

(56) **References Cited**

**U.S. PATENT DOCUMENTS**

D501,649 S \* 2/2005 Yang et al. .... D13/133  
D511,747 S \* 11/2005 Rey et al. .... D13/147

D524,741 S \* 7/2006 Bihrer ..... D13/146  
D530,669 S \* 10/2006 Shing ..... D13/133  
D530,670 S \* 10/2006 Brown et al. .... D13/133  
7,151,223 B2 \* 12/2006 Auray et al. .... 174/70 R  
2005/0118853 A1 \* 6/2005 Starke et al. .... 439/320

\* cited by examiner

*Primary Examiner*—Daniel Bui

(74) *Attorney, Agent, or Firm*—Paul J. Sutton

(57) **CLAIM**

The ornamental design for a latching single cam connector,  
as shown and described.

**DESCRIPTION**

FIG. 1 is a top front and right side perspective view of a  
latching single cam connector showing my new design;

FIG. 2 is a top plan view thereof;

FIG. 3 is a front elevation view thereof;

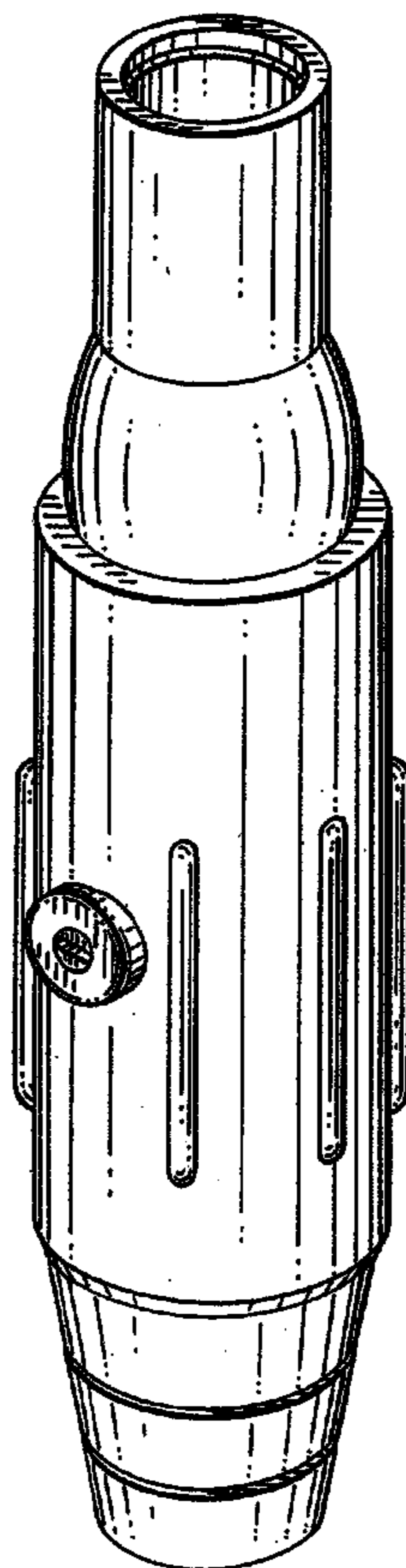
FIG. 4 is a left side elevation view thereof, the right side  
elevation view is a mirror image thereof;

FIG. 5 is a rear elevation view thereof; and,

FIG. 6 is a bottom plan view thereof.

The broken line showing of the environment is for illustra-  
tive purposes only and forms no part of the claimed design.

**1 Claim, 3 Drawing Sheets**



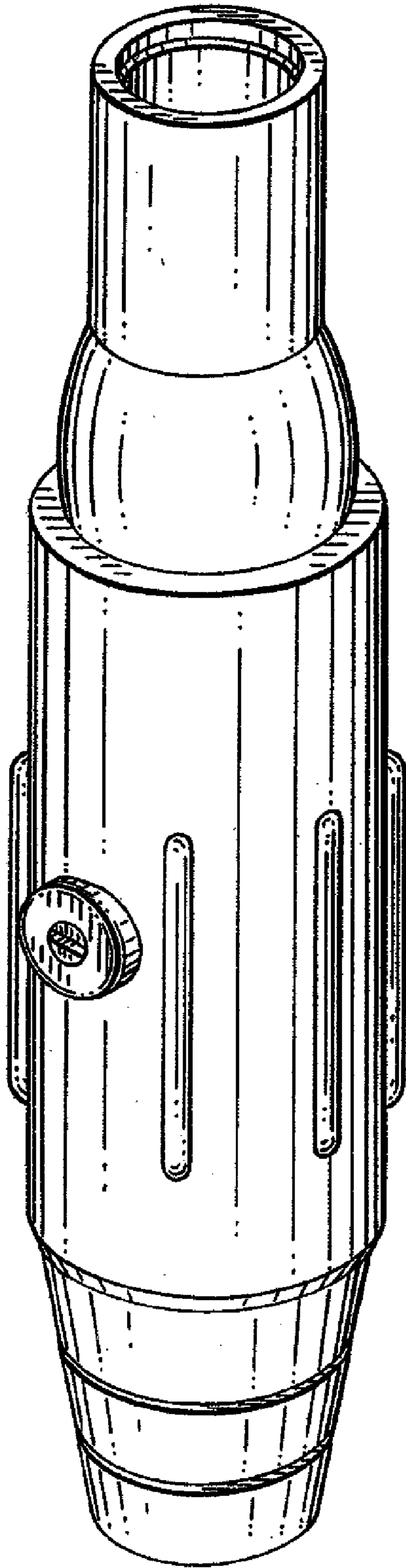


FIG. 1

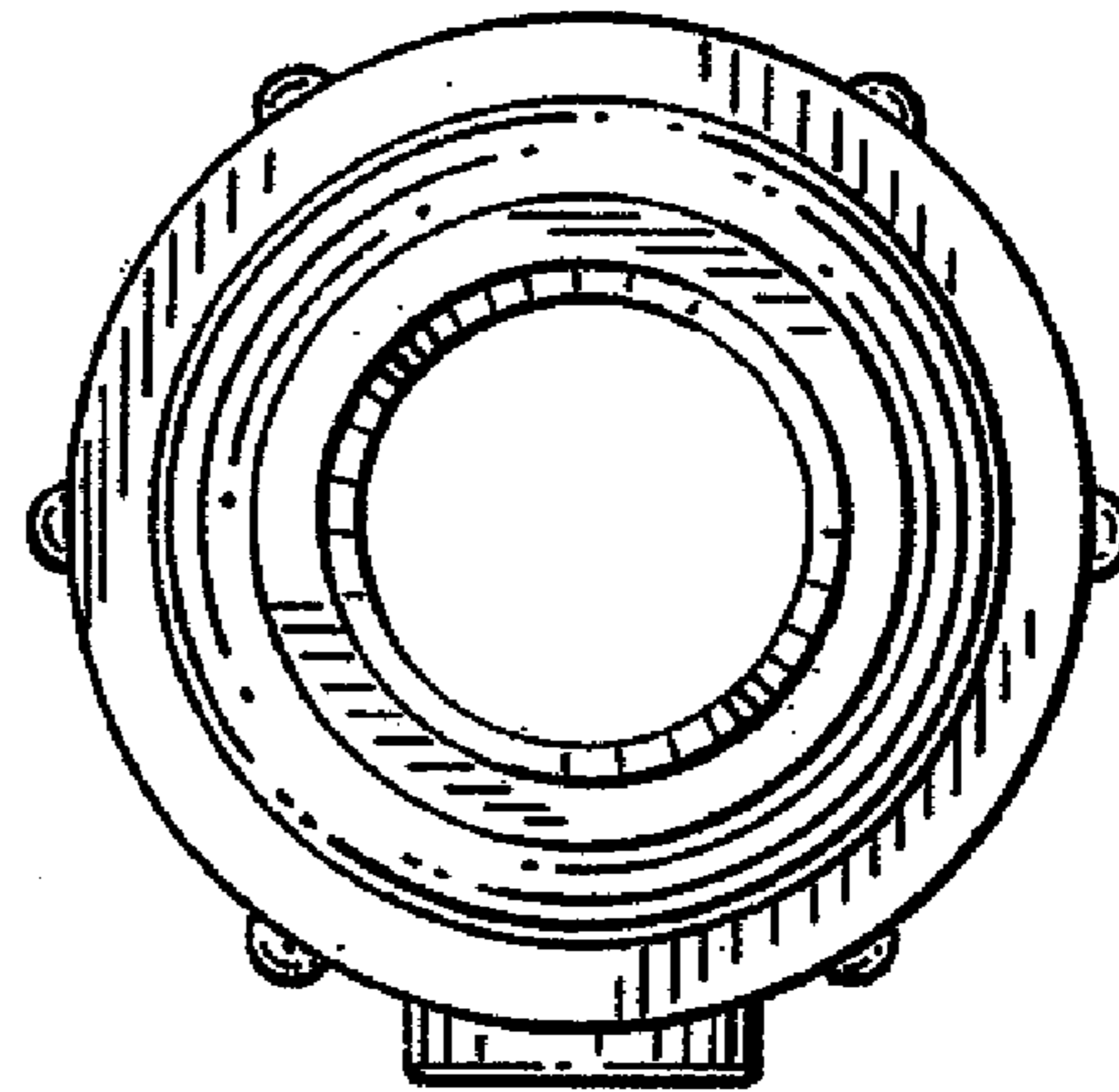
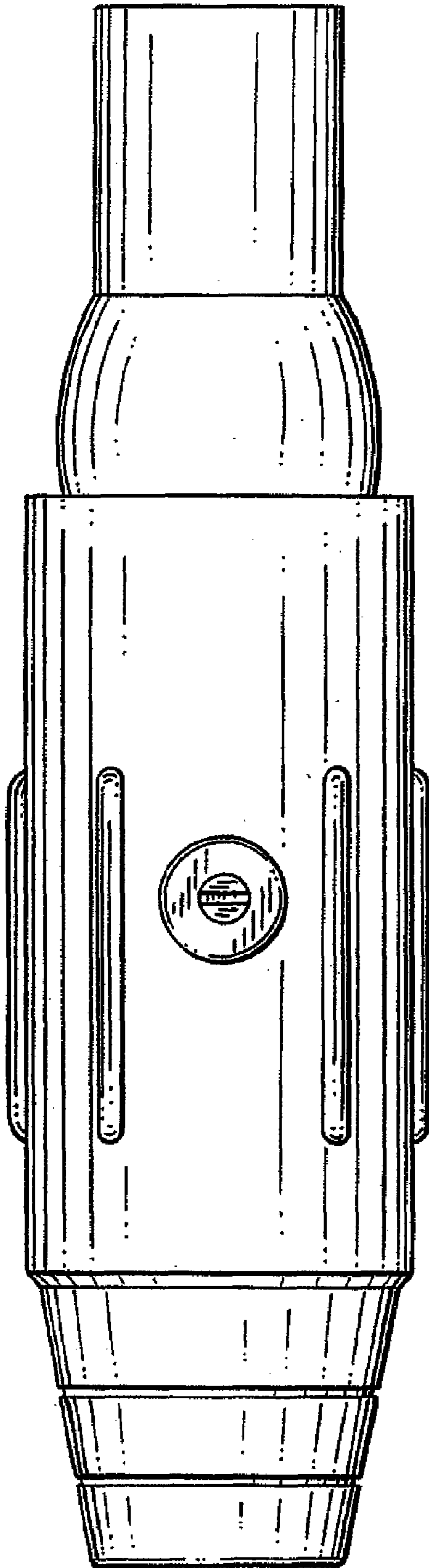
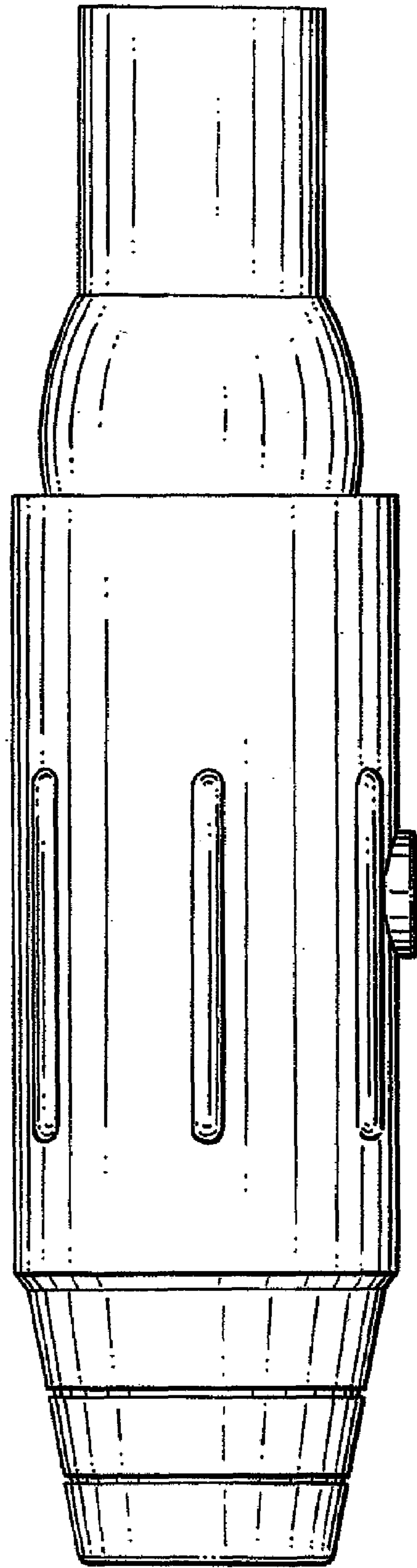


FIG. 2

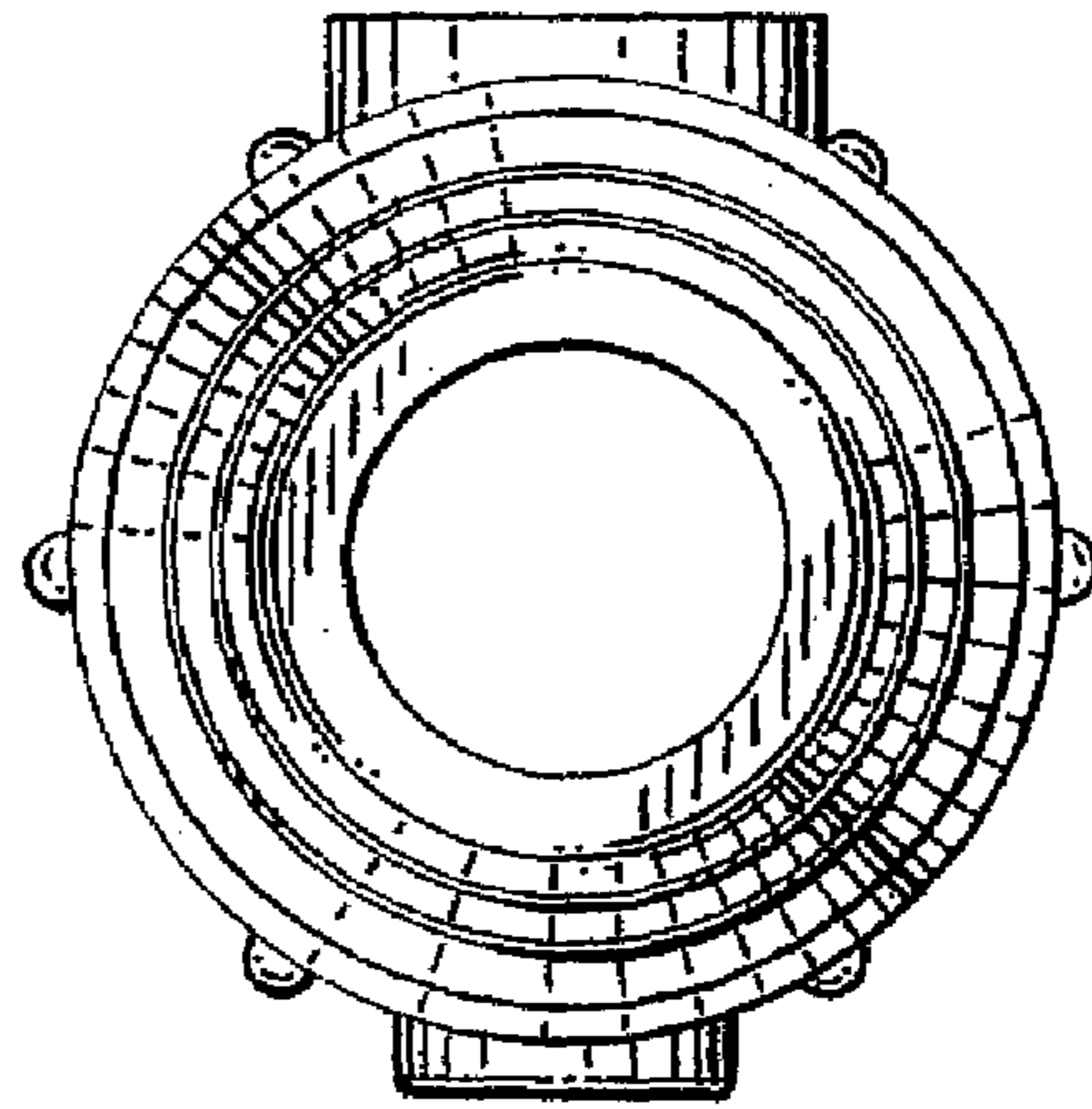
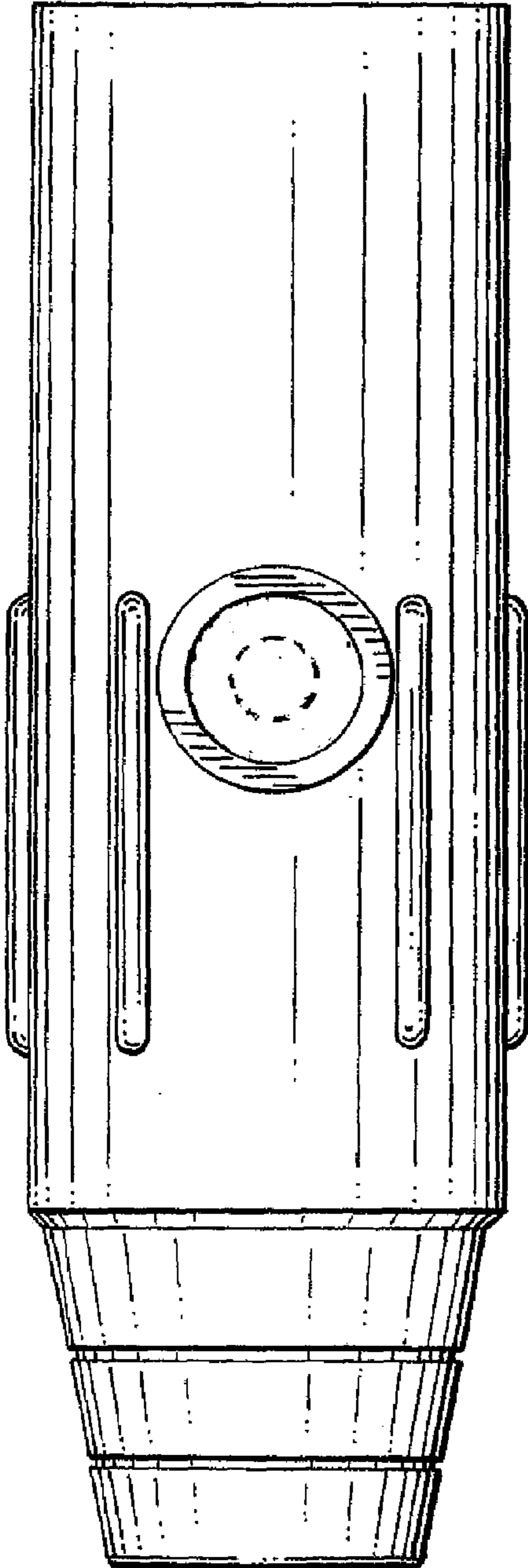
*FIG. 3*



*FIG. 4*



*FIG. 5*



*FIG. 6*

UNITED STATES PATENT AND TRADEMARK OFFICE  
**CERTIFICATE OF CORRECTION**

PATENT NO. : Des. 545,763 S  
APPLICATION NO. : 29/247028  
DATED : July 3, 2007  
INVENTOR(S) : Anthony Tufano, Jr.

Page 1 of 4

It is certified that error appears in the above-identified patent and that said Letters Patent is hereby corrected as shown below:

The title page showing and illustrative figure, should be deleted and substitute therefore the attached title page.

The sheets of drawings consisting of figures 1-4 should be deleted to appear as per attached figures 1-4.

Signed and Sealed this

Fourteenth Day of September, 2010



David J. Kappos  
*Director of the United States Patent and Trademark Office*

(12) **United States Design Patent** (10) **Patent No.:** **US D545,763 S**  
**Tufano, Jr.** (45) **Date of Patent:** **\*\* Jul. 3, 2007**

(54) **LATCHING SINGLE CAM CONNECTOR**

(75) Inventor: **Anthony Tufano, Jr.**, Seaford, NY (US)

(73) Assignee: **Leviton Manufacturing Co., Inc.**, Little Neck, NY (US)

(\*\*) Term: **14 Years**

(21) Appl. No.: **29/247,028**

(22) Filed: **May 24, 2006**

**Related U.S. Application Data**

(62) Division of application No. 29/216,285, filed on Nov. 1, 2004, now Pat. No. Des. 521,931.

(51) **LOC (8) Cl.** ..... **13-03**

(52) **U.S. Cl.** ..... **D13/133**

(58) **Field of Classification Search** ..... D13/133, D13/146, 147, 154, 184, 199; 439/314-322, 439/680, 752

See application file for complete search history.

(56) **References Cited**

**U.S. PATENT DOCUMENTS**

D501,649 S \* 2/2005 Yang et al. .... D13/133  
 D511,747 S \* 11/2005 Rey et al. .... D13/147

D524,741 S \* 7/2006 Bihrer ..... D13/146  
 D530,669 S \* 10/2006 Shing ..... D13/133  
 D530,670 S \* 10/2006 Brown et al. .... D13/133  
 7,151,223 B2 \* 12/2006 Auray et al. .... 174/70 R  
 2005/0118853 A1 \* 6/2005 Starke et al. .... 439/320

\* cited by examiner

*Primary Examiner*—Daniel Bui

(74) *Attorney, Agent, or Firm*—Paul J. Sutton

(57) **CLAIM**

The ornamental design for a latching single cam connector, as shown and described.

**DESCRIPTION**

FIG. 1 is a top front and right side perspective view of a latching single cam connector showing my new design;

FIG. 2 is a top plan view thereof;

FIG. 3 is a front elevation view thereof;

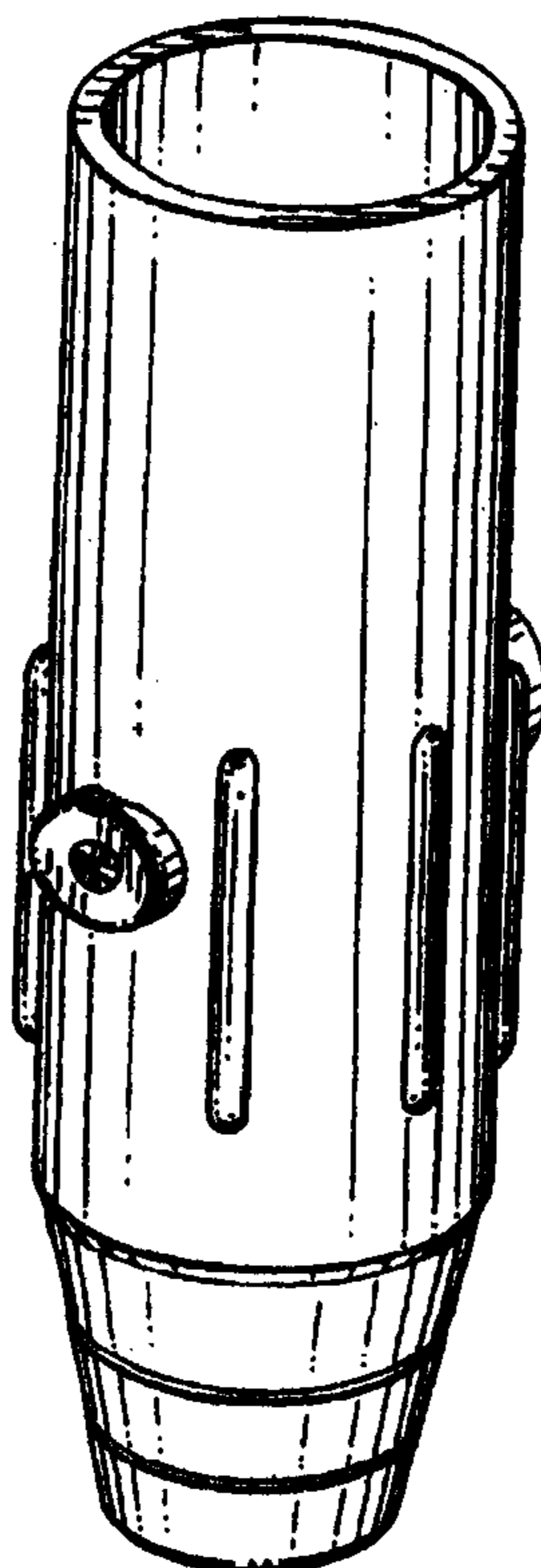
FIG. 4 is a left side elevation view thereof, the right side elevation view is a mirror image thereof;

FIG. 5 is a rear elevation view thereof; and,

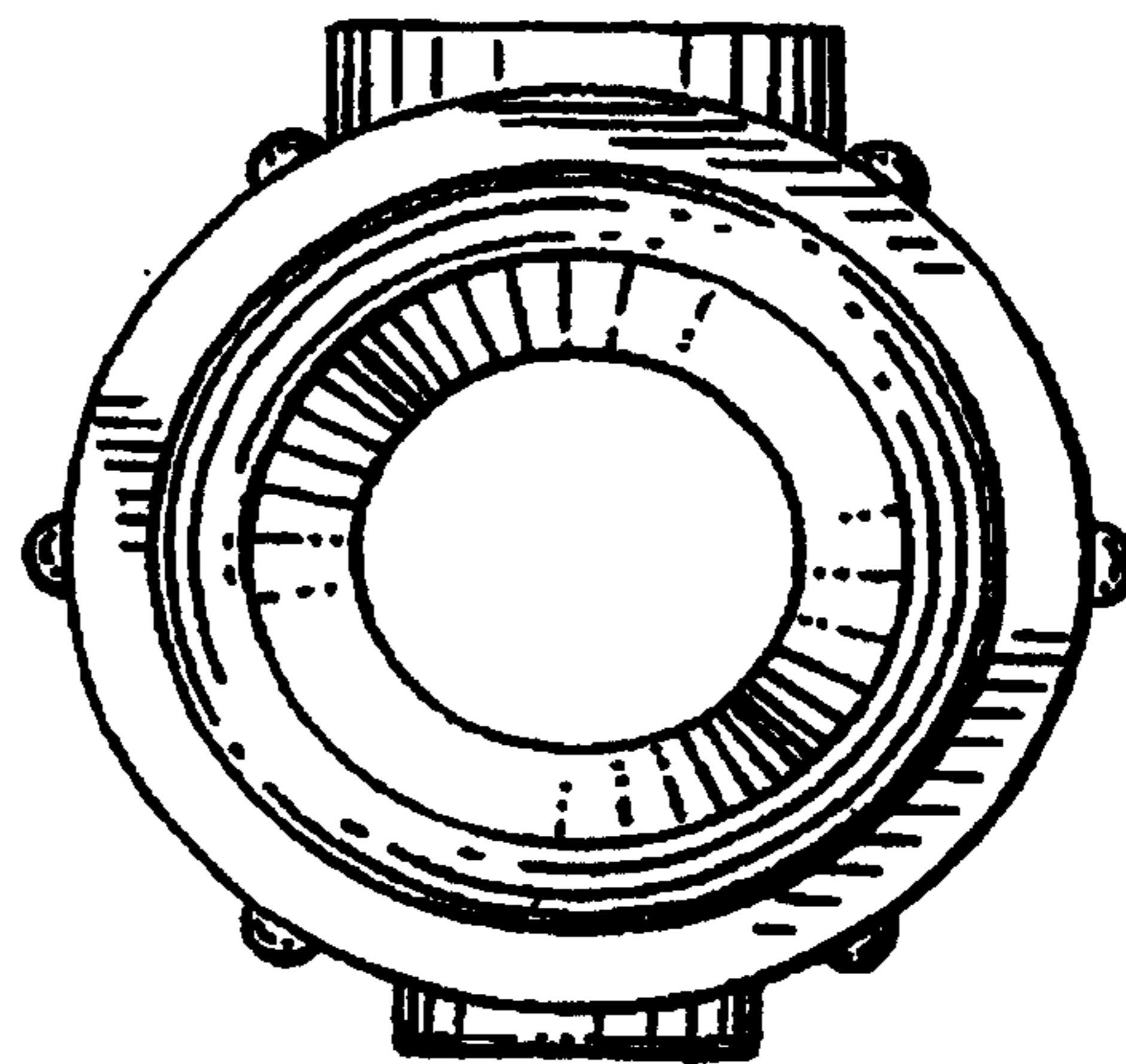
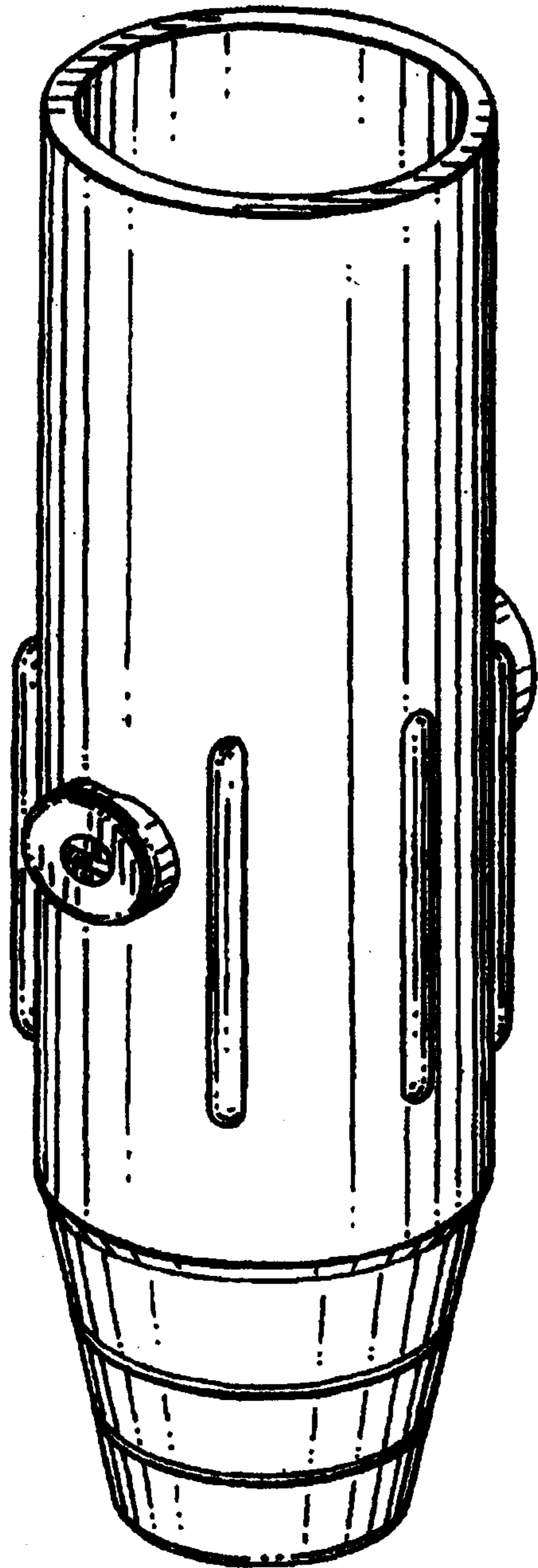
FIG. 6 is a bottom plan view thereof.

The broken line showing of the environment is for illustrative purposes only and forms no part of the claimed design.

**1 Claim, 3 Drawing Sheets**

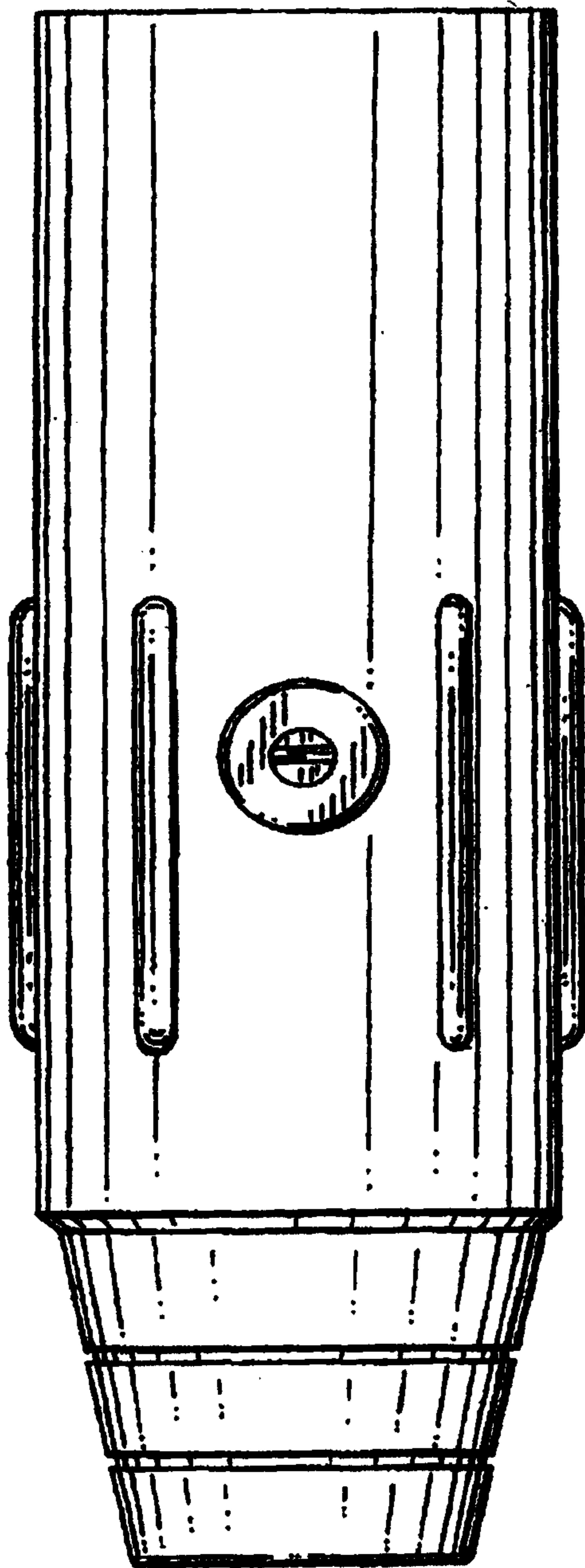


*FIG. 1*



*FIG. 2*

*FIG. 3*



*FIG. 4*

