



US00D545730S

(12) **United States Design Patent**
Lee et al.

(10) **Patent No.:** **US D545,730 S**
(45) **Date of Patent:** **** Jul. 3, 2007**

(54) **COMBINE GRILL BAR AND SURROUND OF A TRUCK VEHICLE**

(75) Inventors: **Kwan W. Lee**, Troy, MI (US); **Kris K. Timmerman**, Huntertown, IN (US); **Ronald F. Mitchell**, Taylor, MI (US); **Marcey K. Collins**, Fort Wayne, IN (US)

(73) Assignee: **International Truck and Engine Corporation Canada**, Warrenville, IL (US)

(**) Term: **14 Years**

(21) Appl. No.: **29/256,330**

(22) Filed: **Mar. 17, 2006**

(51) **LOC (8) Cl.** **12-16**

(52) **U.S. Cl.** **D12/163**

(58) **Field of Classification Search** D12/163, D12/171, 90-92, 96, 169, 196; 180/68.1, 180/68.6; 296/193.11; 293/102, 113, 115
See application file for complete search history.

(56) **References Cited**

U.S. PATENT DOCUMENTS

D447,099 S 8/2001 Tirey et al.
D452,464 S 12/2001 Beigel

D455,381 S 4/2002 Maher et al.
D460,023 S * 7/2002 Beigel D12/96
D466,450 S * 12/2002 Maher et al. D12/96
D522,936 S 6/2006 Beigel et al.
D528,050 S * 9/2006 McCuller et al. D12/163
D530,247 S * 10/2006 Angelo et al. D12/163

* cited by examiner

Primary Examiner—Melody N. Brown

(74) *Attorney, Agent, or Firm*—Gerald W. Askew; Jeffrey P. Calfa; Susan L. Lukasik

(57) **CLAIM**

The ornamental design for a combine grill bar and surround of a truck vehicle, as shown and described.

DESCRIPTION

FIG. 1 is a left, front perspective view of a combine grill bar and surround of a truck vehicle showing our new design;

FIG. 2 is a front view thereof;

FIG. 3 is a rear view thereof;

FIG. 4 is a bottom up view thereof;

FIG. 5 is a top view thereof;

FIG. 6 is a left view thereof; and,

FIG. 7 is a right view thereof.

1 Claim, 3 Drawing Sheets

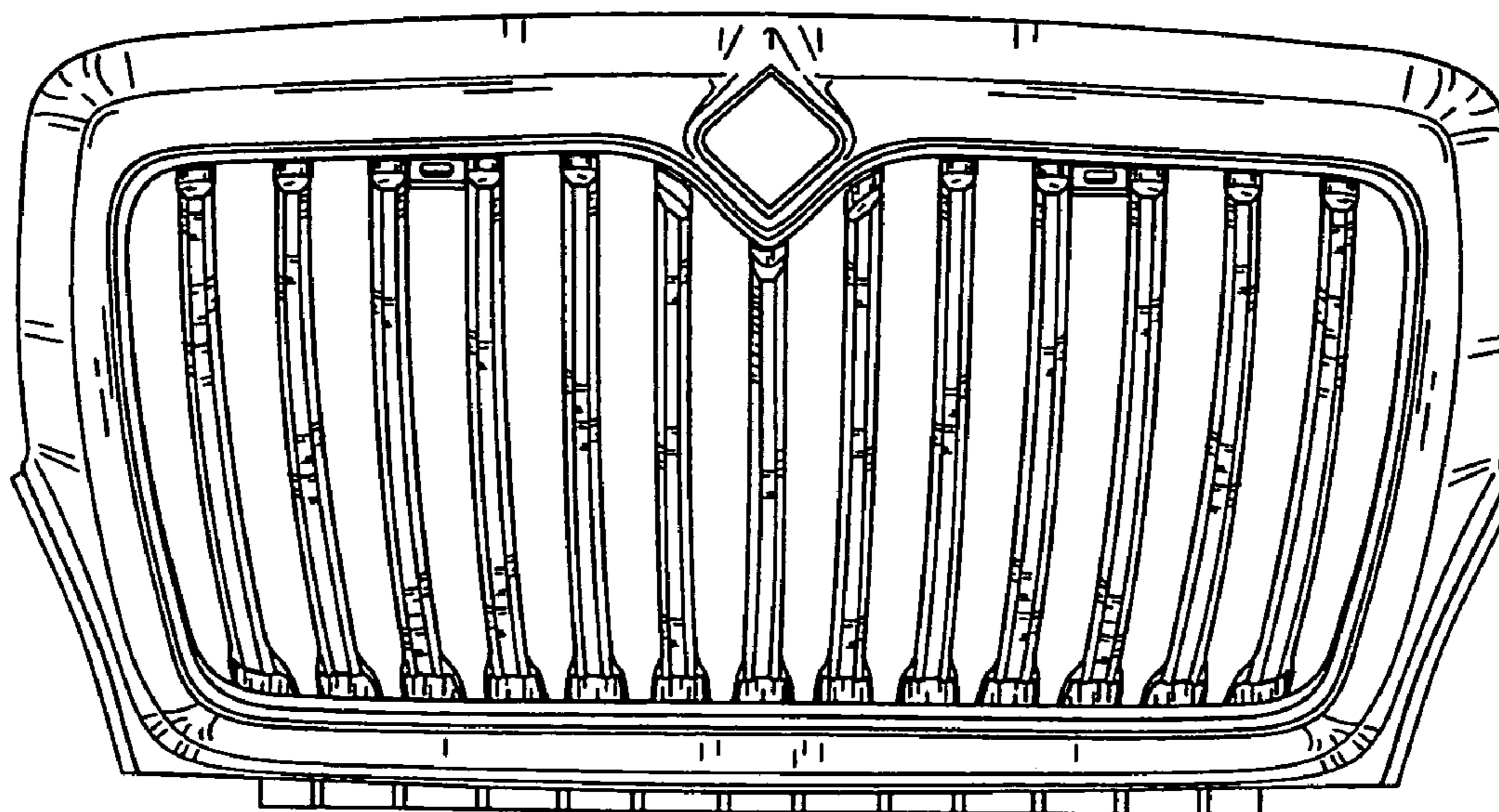

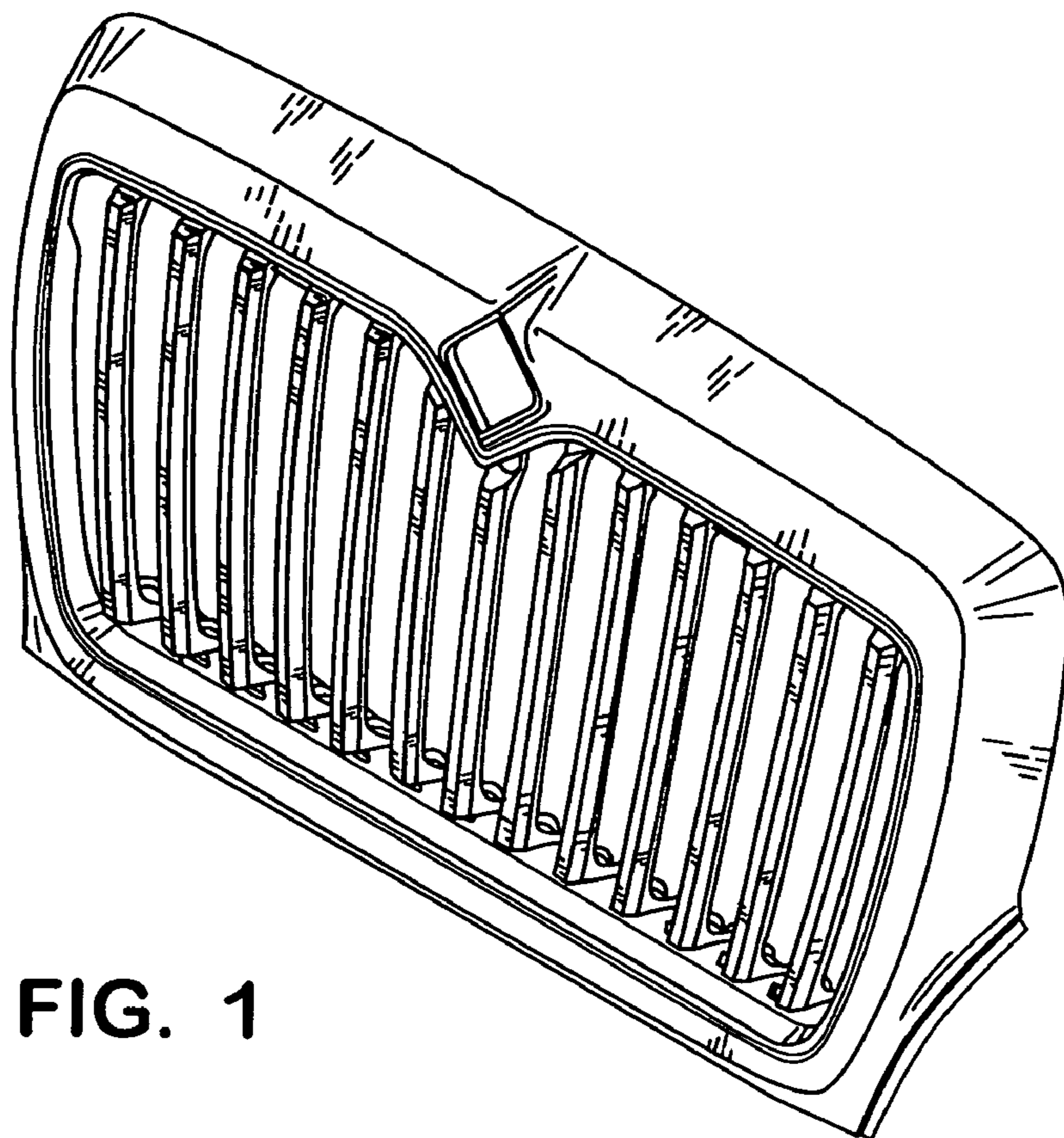

FIG. 1

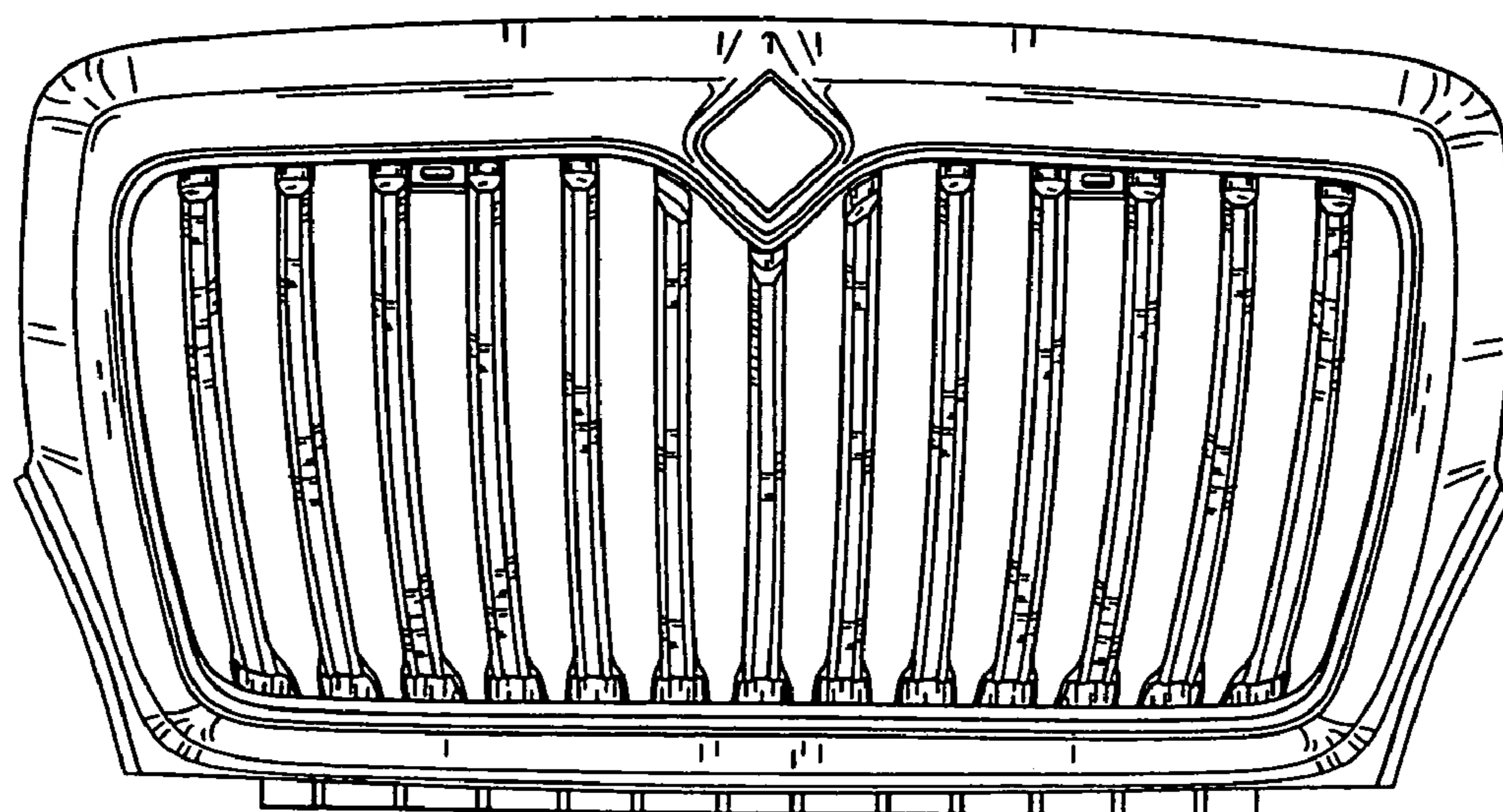

FIG. 2

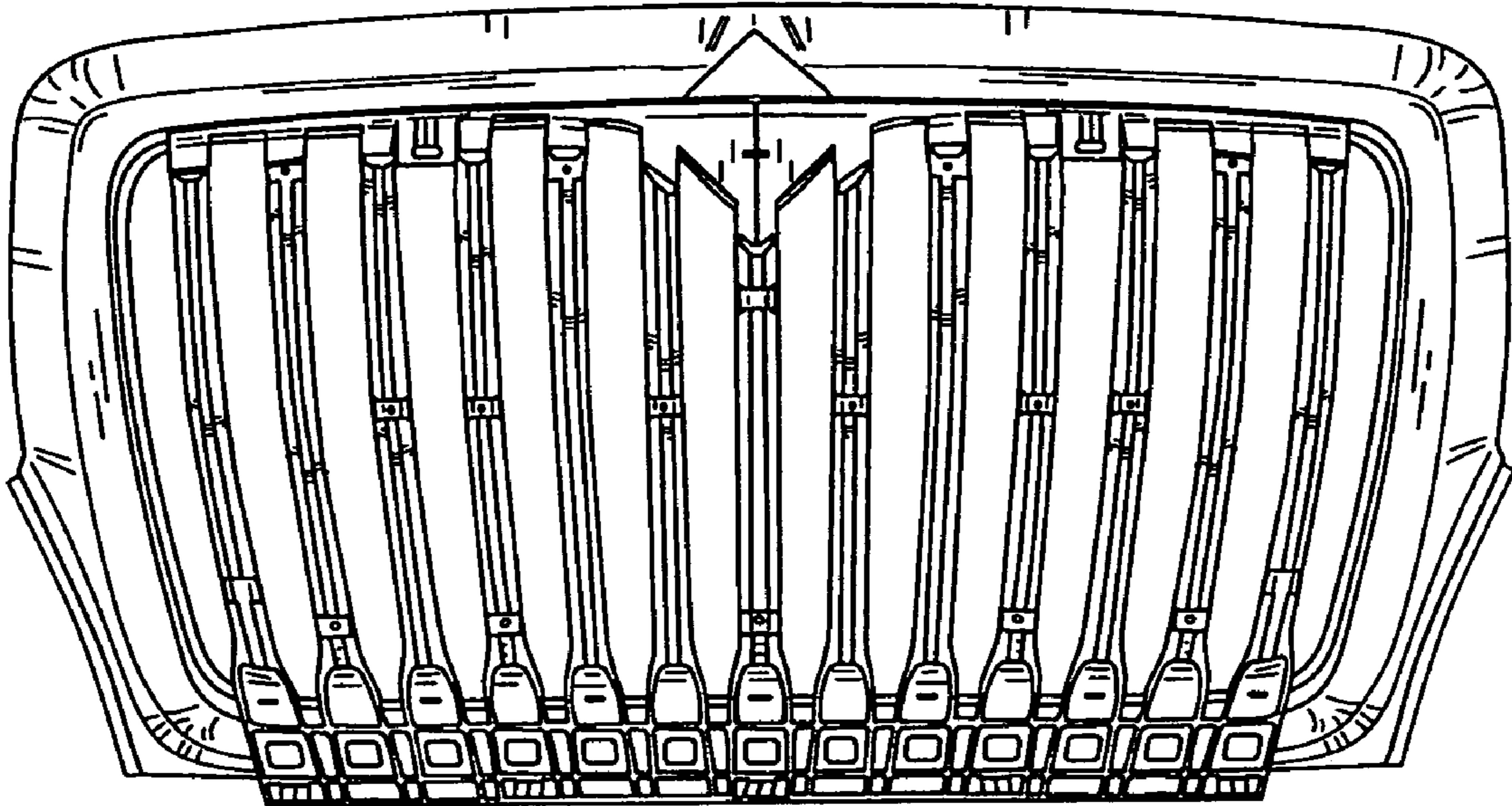

FIG. 3

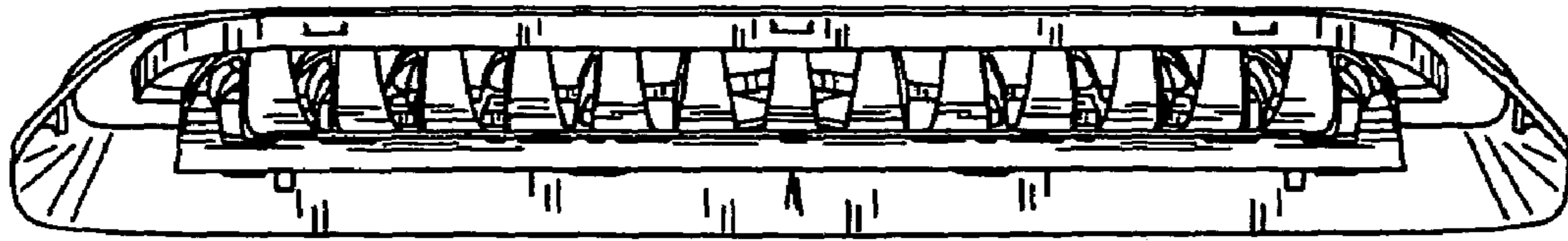

FIG. 4

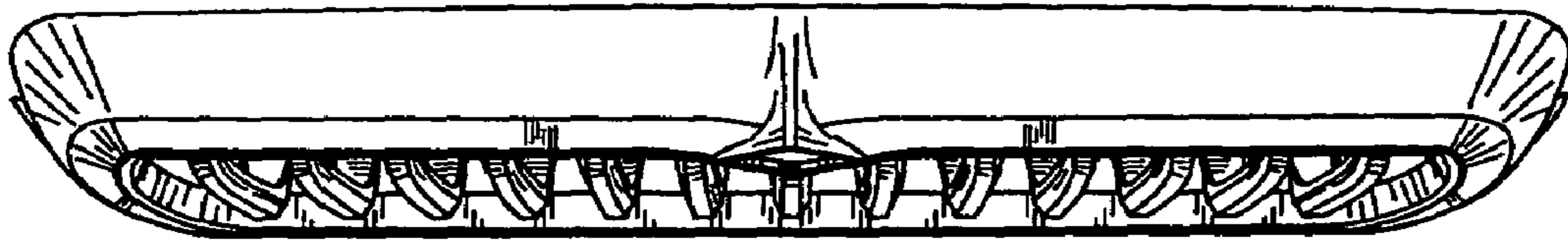

FIG. 5

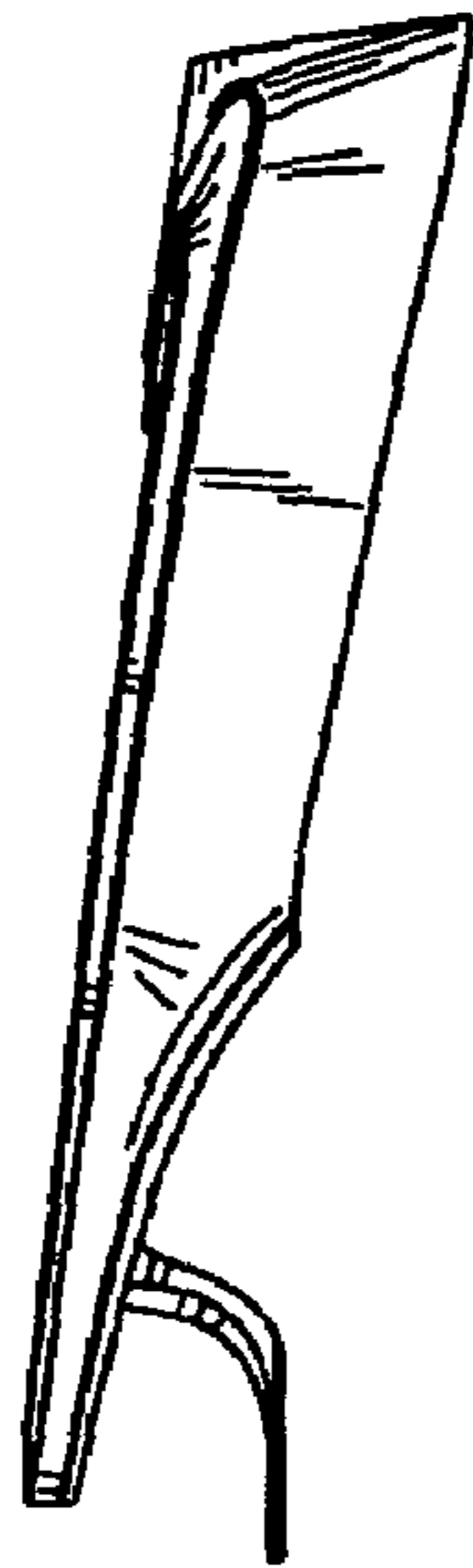

FIG. 6



FIG. 7