

US00D545593S

(12) **United States Design Patent**
Wheeler

(10) **Patent No.:** **US D545,593 S**

(45) **Date of Patent:** **** Jul. 3, 2007**

(54) **CONSOLE**

(75) **Inventor:** **Giles Christopher Wheeler**, Solihull (GB)

(73) **Assignee:** **Sefour Limited**, Solihull (GB)

(**) **Term:** **14 Years**

(21) **Appl. No.:** **29/251,979**

(22) **Filed:** **Jan. 17, 2006**

(51) **LOC (8) Cl.** **06-04**

(52) **U.S. Cl.** **D6/478**

(58) **Field of Classification Search** D6/477-479, D6/436, 560, 409-411; 211/189-190, 194, 211/188, 187; 312/111, 108; 217/36; D18/59
See application file for complete search history.

(56) **References Cited**

U.S. PATENT DOCUMENTS

- D139,708 S * 12/1944 Lapin D6/336
- D285,852 S * 9/1986 Clark D34/21
- D311,291 S * 10/1990 Ugalde D6/474
- D365,709 S * 1/1996 Leveen et al. D6/474
- D374,135 S * 10/1996 Lladro Roig et al. D6/436

- D396,376 S * 7/1998 Sze-Man D6/630
- D414,069 S * 9/1999 Fok D6/630
- D425,727 S * 5/2000 Ishikawa D6/425
- 7,083,056 B2 * 8/2006 Routhier 211/90.04

* cited by examiner

Primary Examiner—Cathron C. Brooks
Assistant Examiner—Kelley A. Donnelly

(57) **CLAIM**

The ornamental design for the console, as shown and described.

DESCRIPTION

FIG. 1 is a perspective view of my console;
FIG. 2 is a back view of my console;
FIG. 3 is a front view of my console;
FIG. 4 is left side view of my console;
FIG. 5 is a right side view of my console;
FIG. 6 is a top view of my console; and,
FIG. 7 is a bottom view of my console.

1 Claim, 7 Drawing Sheets

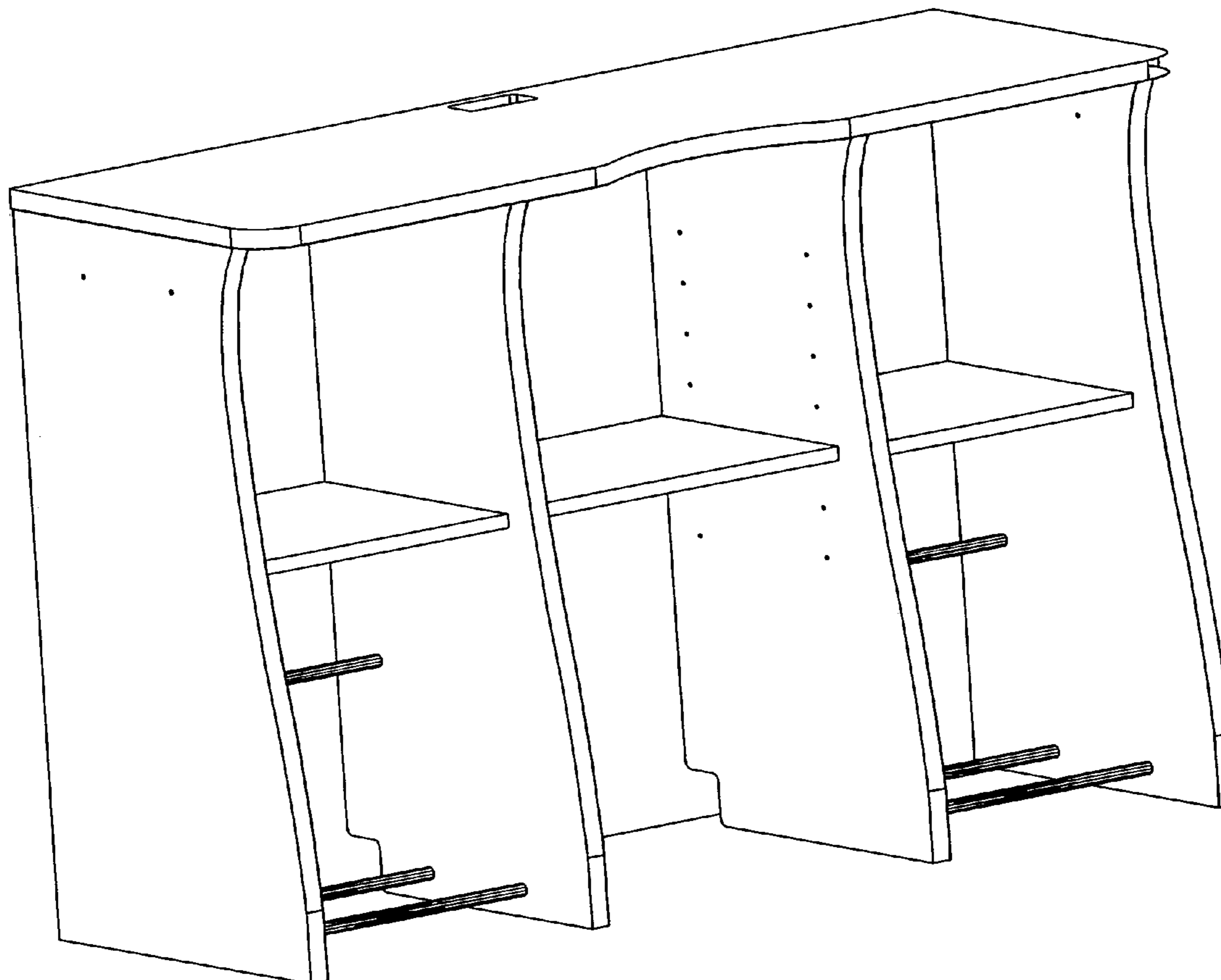

Figure 1

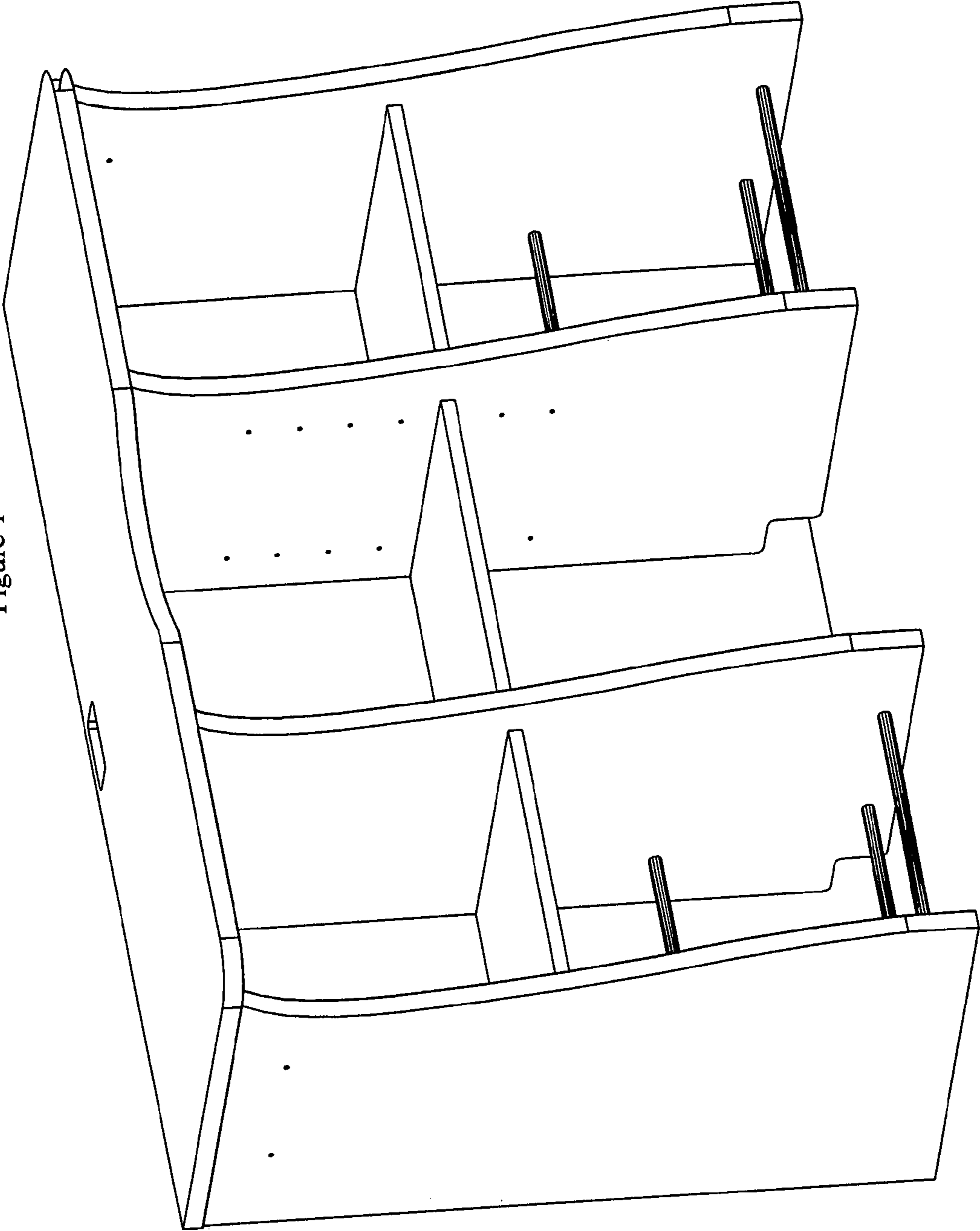

Figure 2

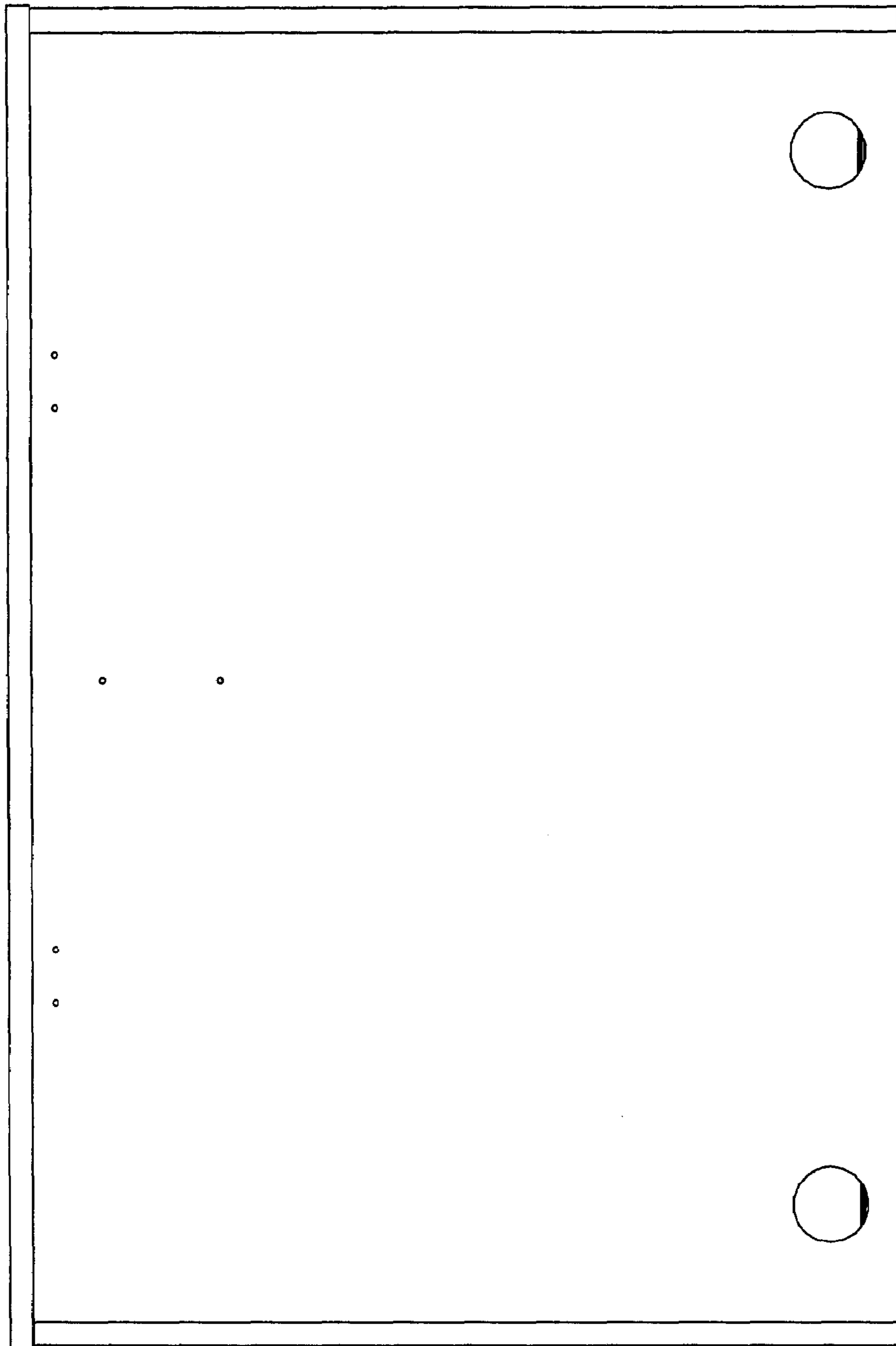

Figure 3

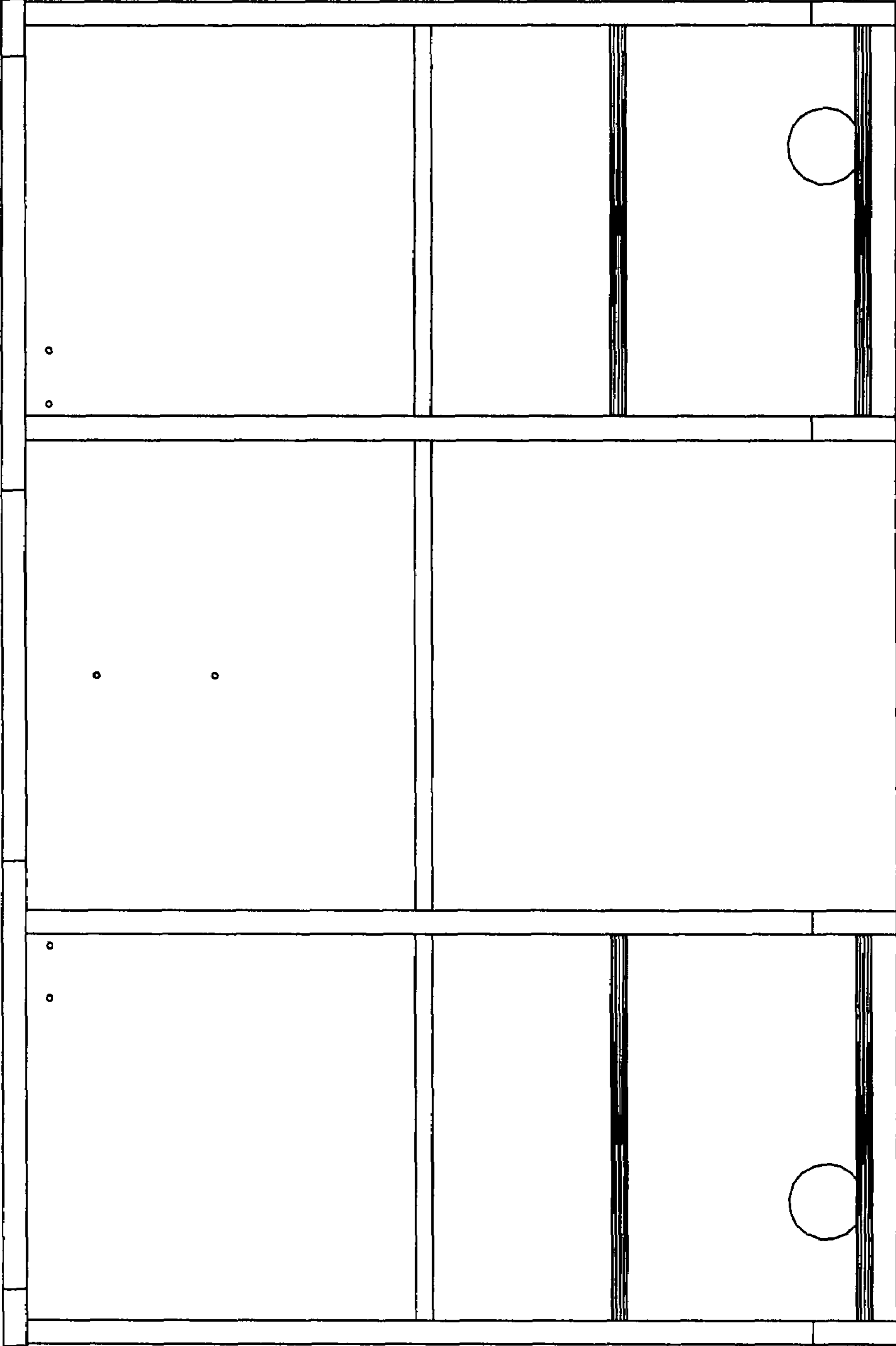

Figure 4

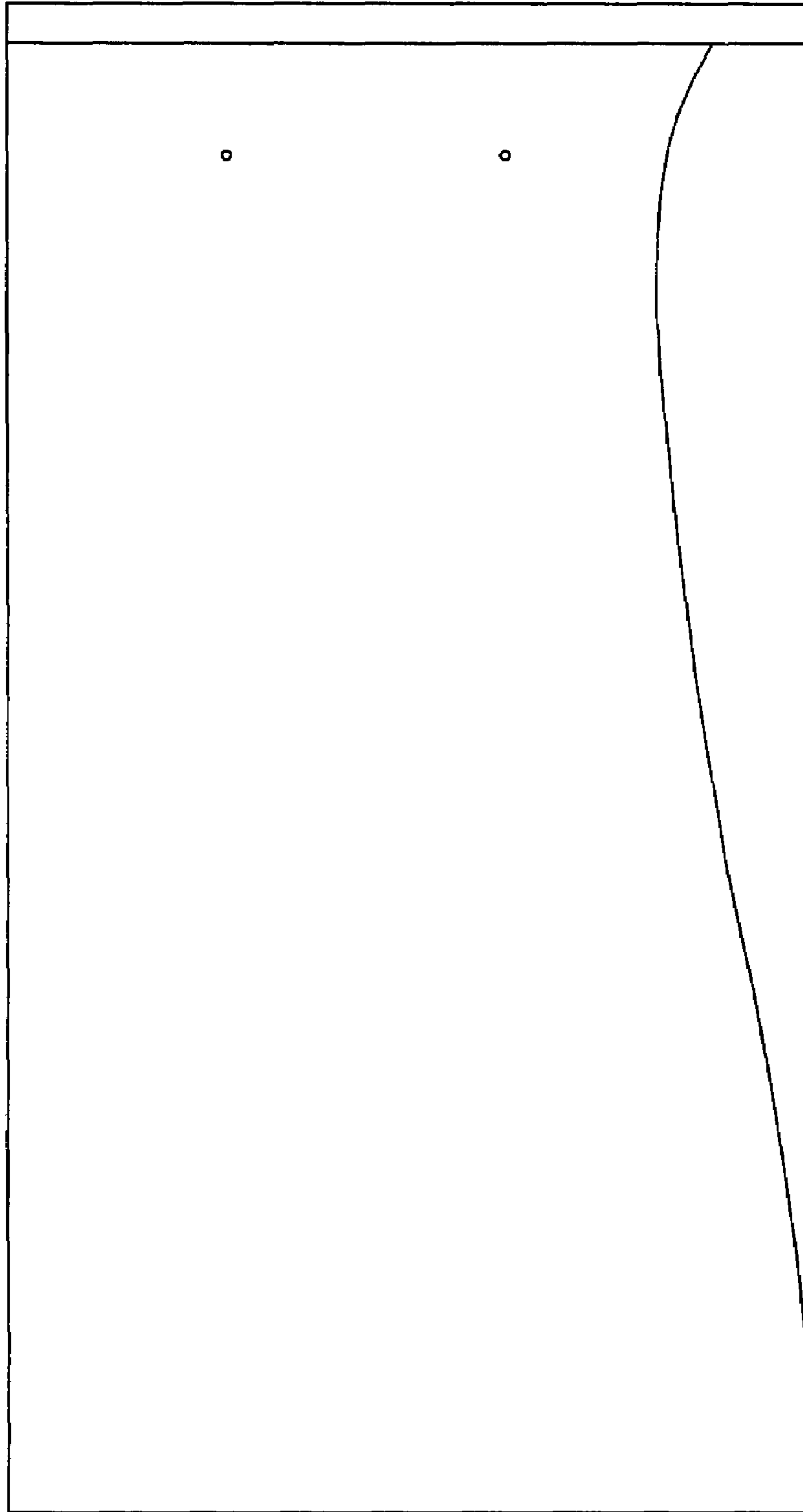

Figure 5

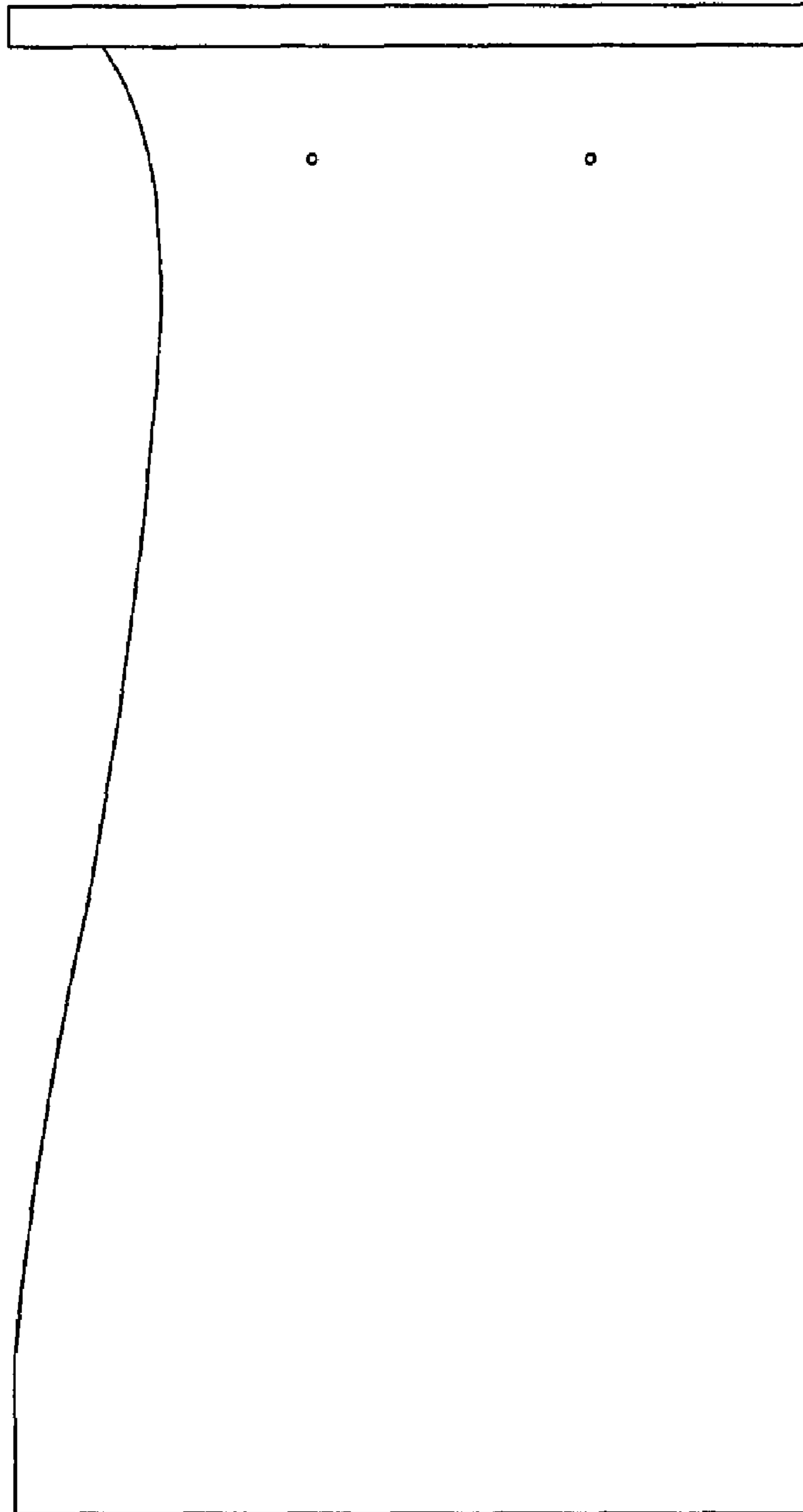

Figure 6

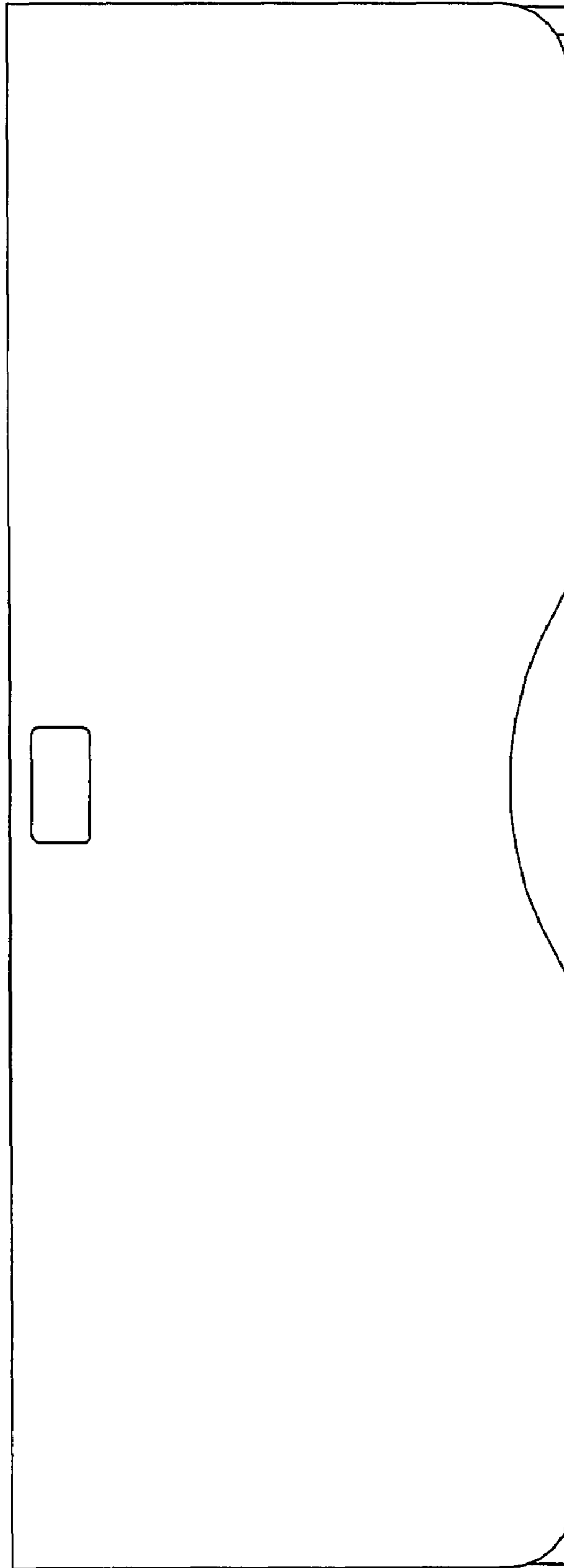

Figure 7

