



US00D545564S

(12) **United States Design Patent** (10) **Patent No.:** **US D545,564 S**
Davis (45) **Date of Patent:** **** Jul. 3, 2007**

(54) **WRIST STRAP FOR ROTATING CELL PHONE HOLDERS**

(75) Inventor: **Larry Lynn Davis**, Fremont, CA (US)

(73) Assignee: **Larry L. Davis**, Union City, CA (US)

(**) Term: **14 Years**

(21) Appl. No.: **29/224,259**

(22) Filed: **Feb. 28, 2005**

(51) **LOC (8) Cl.** **03-01**

(52) **U.S. Cl.** **D3/218**

(58) **Field of Classification Search** D3/218,
D3/215, 224, 226, 228; 224/219, 222, 267,
224/240, 236, 901, 904

See application file for complete search history.

(56) **References Cited**

U.S. PATENT DOCUMENTS

D455,255 S *	4/2002	Zeigler	D3/218
D493,279 S	7/2004	Tabata		
D493,280 S	7/2004	Tabata		
D503,038 S *	3/2005	Tabata	D3/218
D504,224 S *	4/2005	Sexson	D3/218
D506,058 S *	6/2005	Sexson	D3/218
2003/0019894 A1 *	1/2003	Caldana	224/219

* cited by examiner

Primary Examiner—Catherine R. Oliver

(74) *Attorney, Agent, or Firm*—Larry L. Davis

(57) **CLAIM**

The ornamental design for a wrist strap for rotating cell phone holders, as shown and described.

DESCRIPTION

FIG. 1 is a front elevational view of a wrist strap for rotating cell phone holders, showing my new design:

FIG. 2 is a left side elevational view thereof:

FIG. 3 is a bottom plan view thereof:

FIG. 4 is a rear elevational view thereof:

FIG. 5 is a right side elevational view thereof:

FIG. 6 is a top plan view thereof:

FIG. 7 is a perspective view thereof: and

FIG. 8 is an elevational view thereof showing it mounted on a rotating cell phone holder, with a cell phone and wrist straps shown by the broken lines.

The broken line disclosing a cell phone holder, a cell phone and wrist straps is for illustrative purposes only and forms no part of the claimed design; and,

FIG. 9 is a exploded view thereof: showing a rotating cell phone holder, a cell phone, wrist straps and connecting pins shown by broken lines.

The broken line disclosing a cell phone holder, a cell phone, wrist straps and connecting pins is for illustrative purposes only and forms no part of the claimed design.

1 Claim, 4 Drawing Sheets

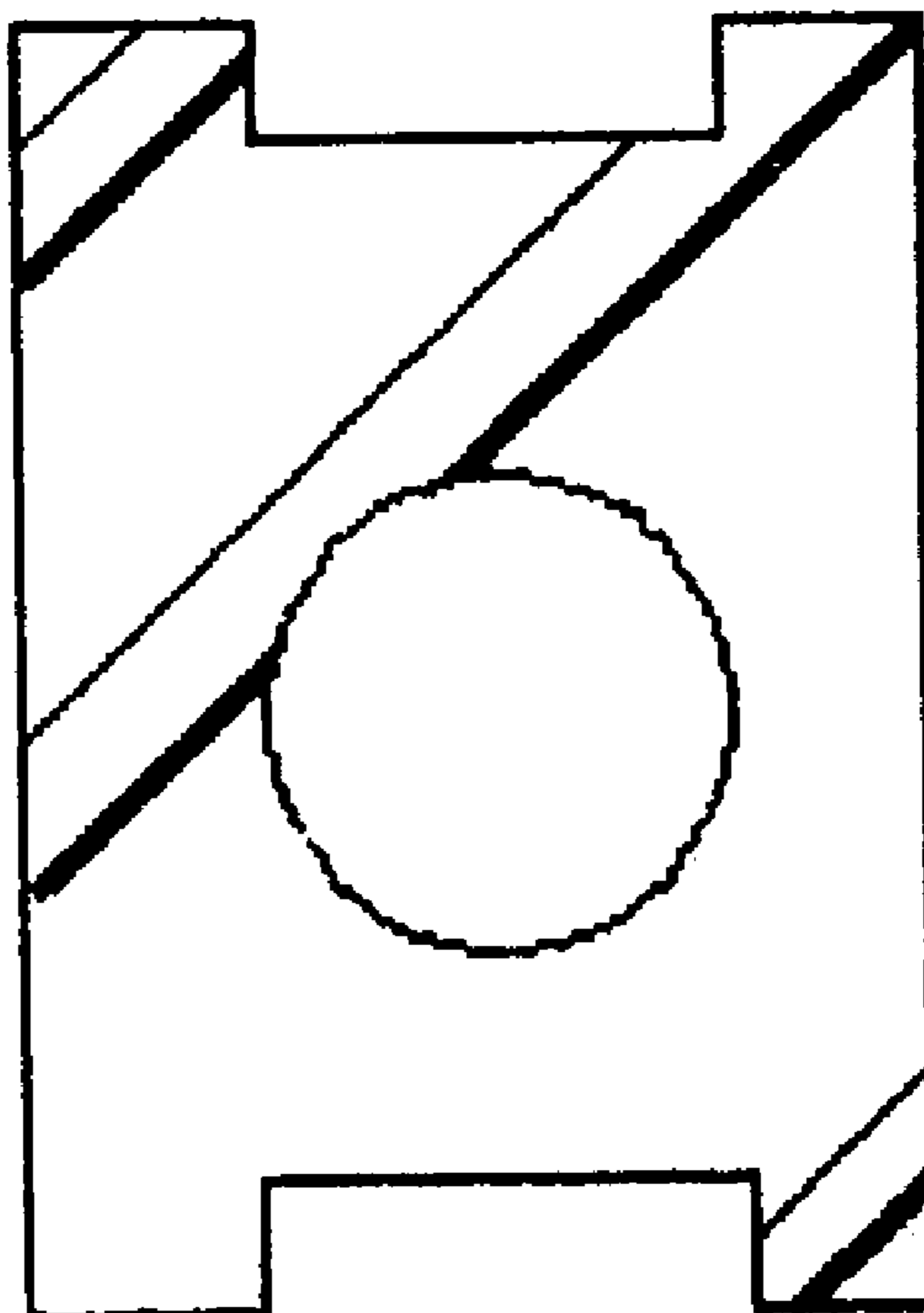

Fig.2



Fig.1

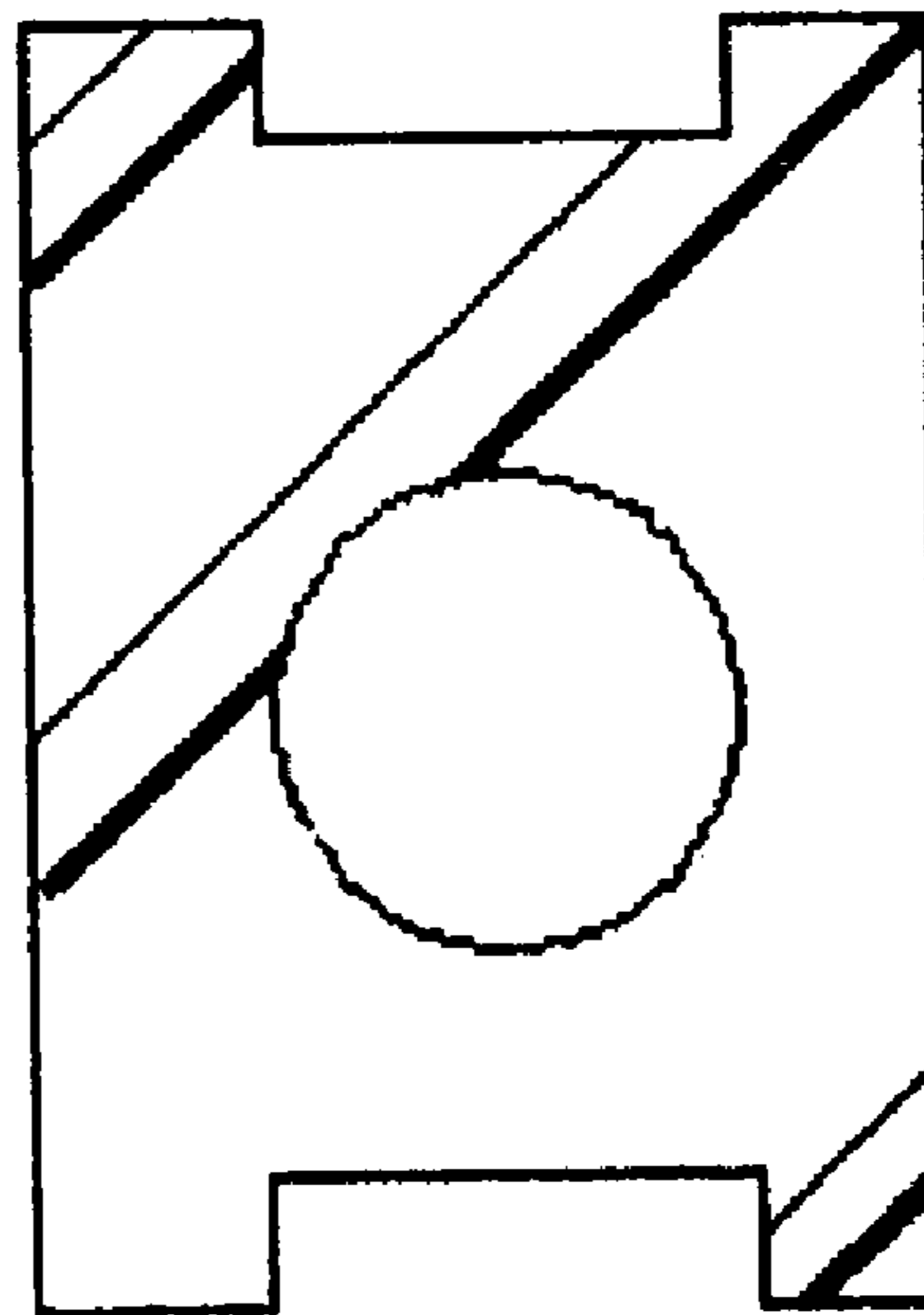

Fig.3



Fig.5



Fig.6



Fig.4

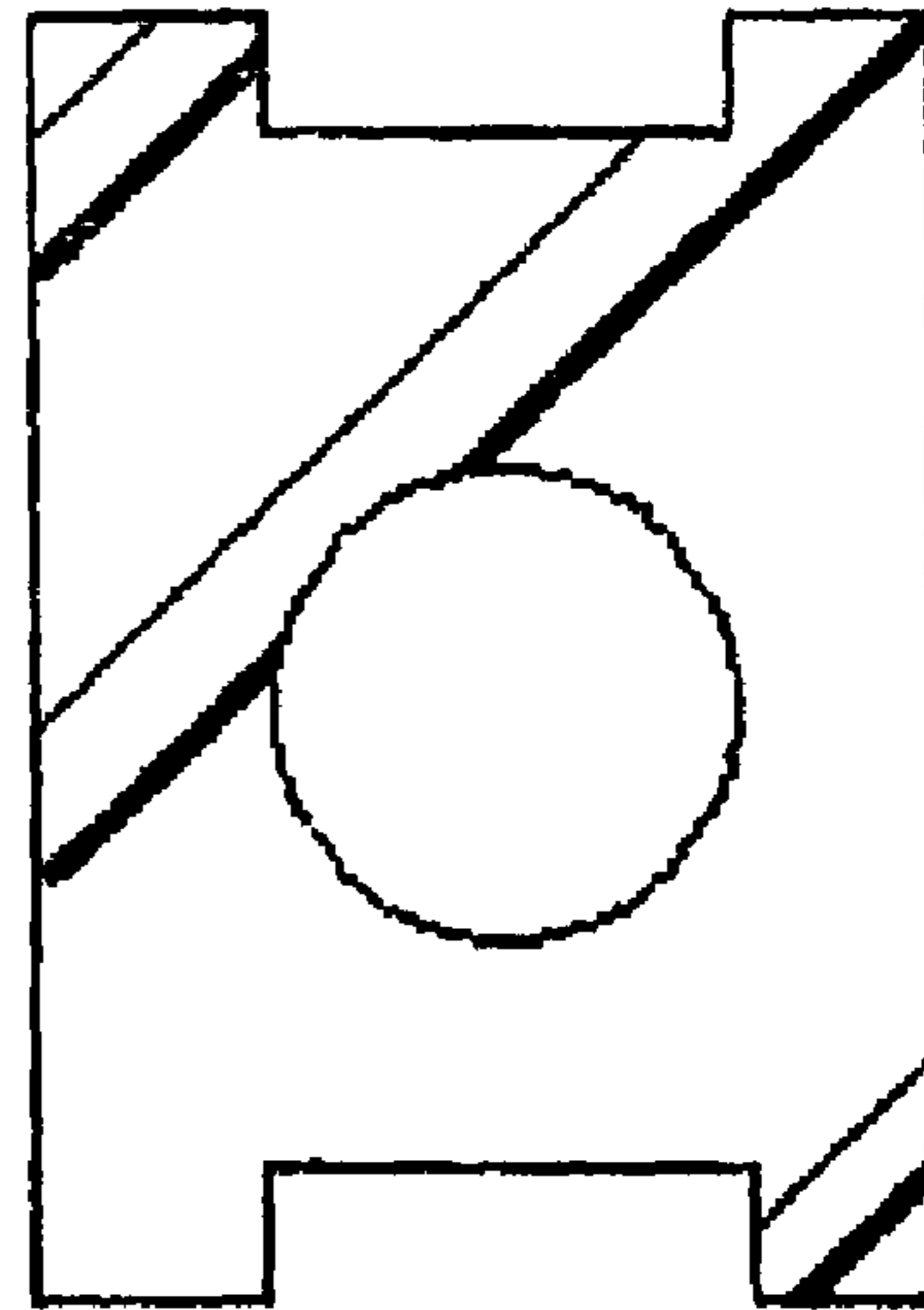

Fig.7

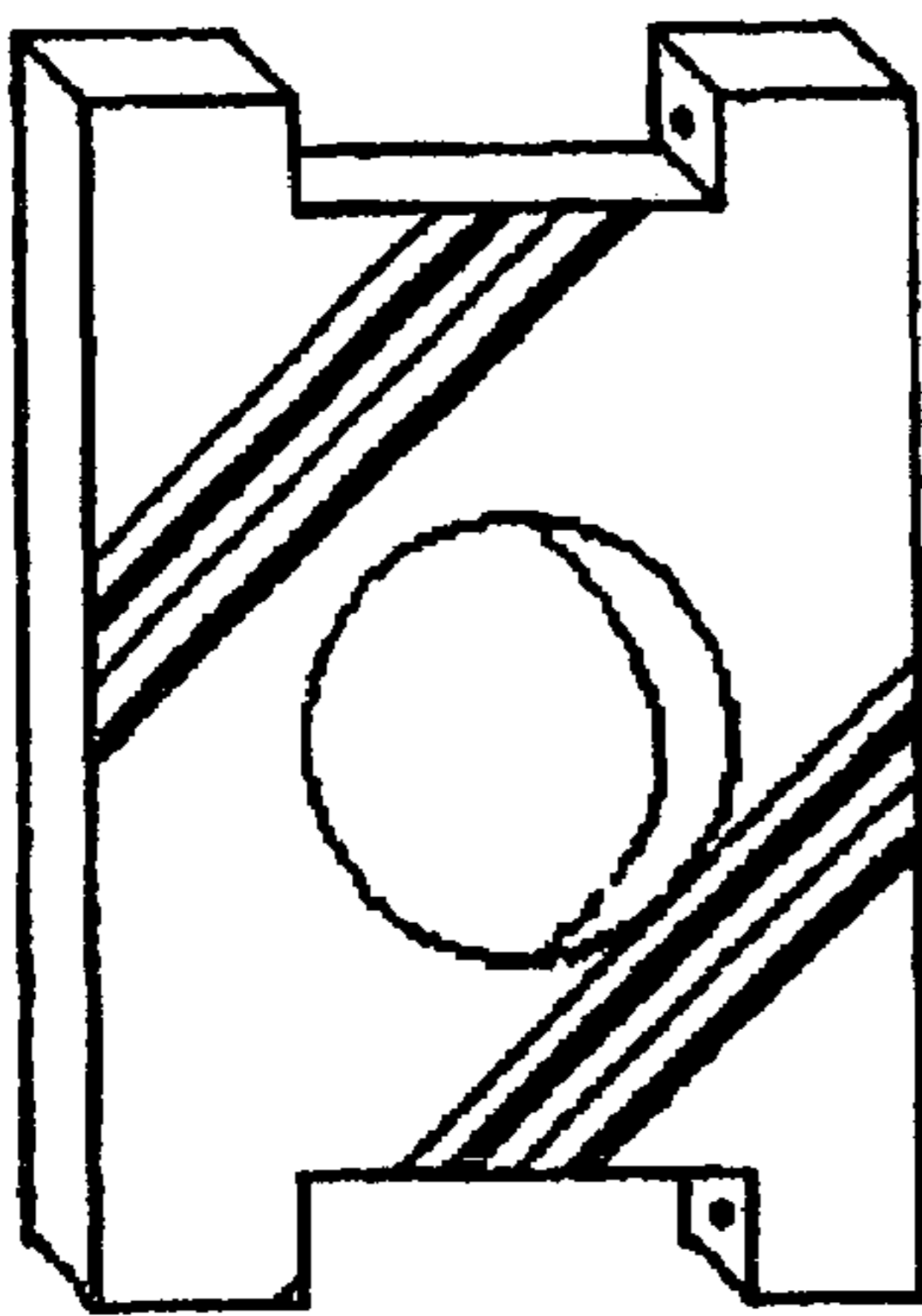
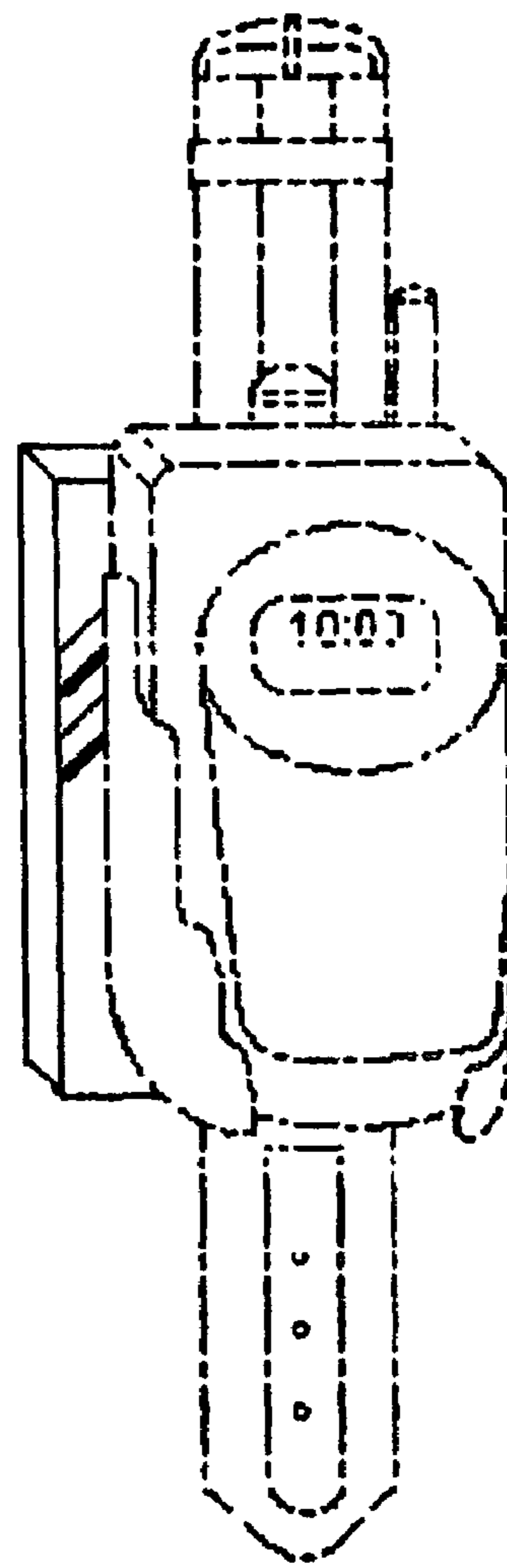
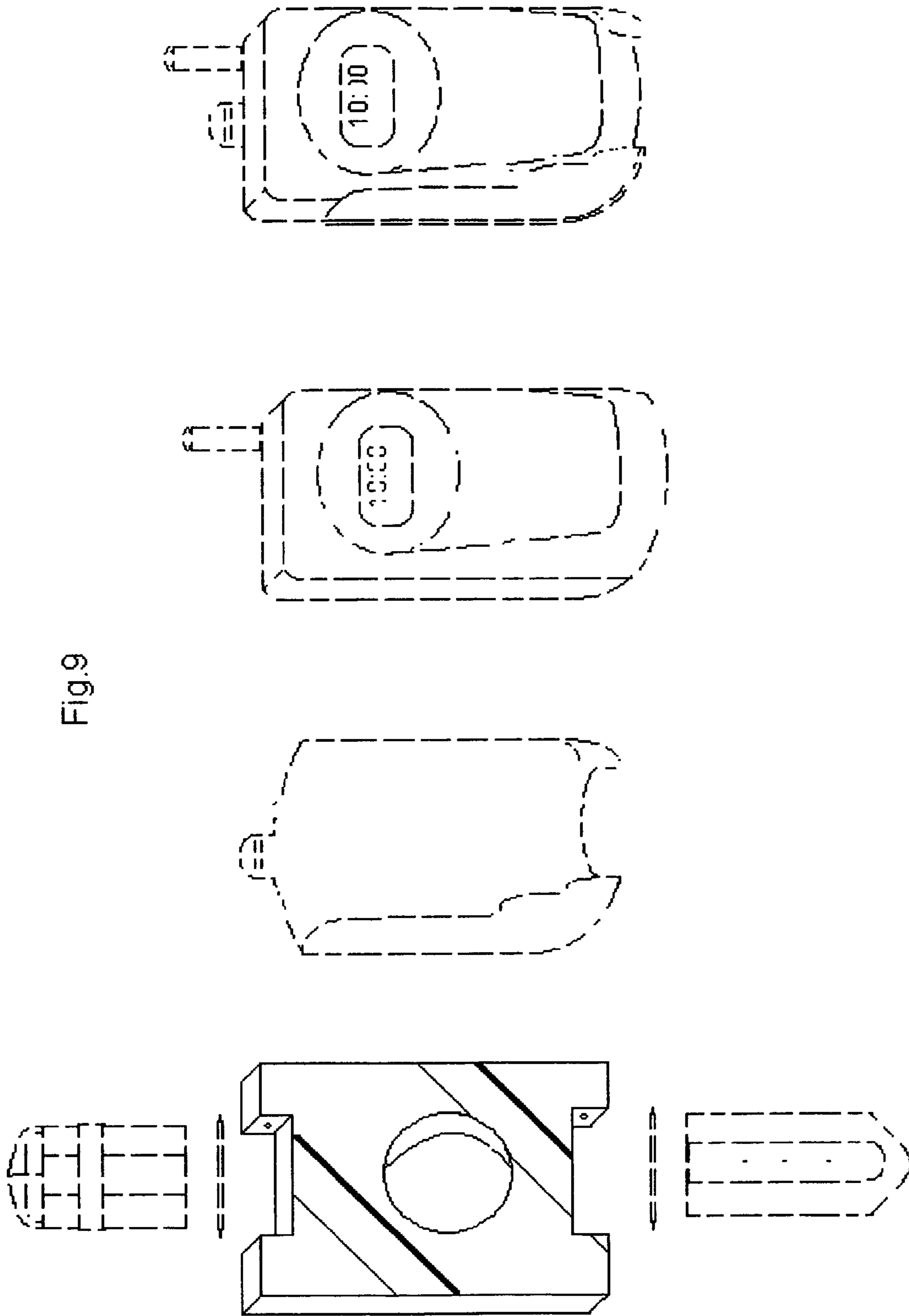

Fig.8





UNITED STATES PATENT AND TRADEMARK OFFICE
CERTIFICATE OF CORRECTION

PATENT NO. : Des. 545,564 S
APPLICATION NO. : 29/224259
DATED : July 3, 2007
INVENTOR(S) : Larry Lynn Davis

Page 1 of 2

It is certified that error appears in the above-identified patent and that said Letters Patent is hereby corrected as shown below:

The title page, showing an illustrative figure, should be deleted and substitute therefor the attached title page

Signed and Sealed this

Thirteenth Day of November, 2007

A handwritten signature in black ink on a light gray dotted background. The signature reads "Jon W. Dudas" in a cursive style.

JON W. DUDAS

Director of the United States Patent and Trademark Office

(12) **United States Design Patent** (10) Patent No.: **US D545,564 S**
 Davis (45) Date of Patent: **** Jul. 3, 2007**

(54) **WRIST STRAP FOR ROTATING CELL PHONE HOLDERS**

(75) Inventor: Larry Lynn Davis, Fremont, CA (US)

(73) Assignee: Larry L. Davis, Union City, CA (US)

(**) Term: 14 Years

(21) Appl. No.: 29/224,259

(22) Filed: Feb. 28, 2005

(51) LOC (8) Cl. 03-01

(52) U.S. Cl. D3/218

(58) Field of Classification Search D3/218,
 D3/215, 224, 226, 228; 224/219, 222, 267,
 224/240, 236, 901, 904

See application file for complete search history.

(56) **References Cited**

U.S. PATENT DOCUMENTS

D455,255 S *	4/2002	Zeigler	D3/218
D493,279 S	7/2004	Tabata		
D493,280 S	7/2004	Tabata		
D503,038 S *	3/2005	Tabata	D3/218
D504,224 S *	4/2005	Saxson	D3/218
D506,058 S *	6/2005	Saxson	D3/218
2003/0019894 A1 *	1/2003	Caldana	224/219

* cited by examiner

Primary Examiner—Catherine R. Oliver

(74) Attorney, Agent, or Firm—Larry L. Davis

(57) **CLAIM**

The ornamental design for a wrist strap for rotating cell phone holders, as shown and described.

DESCRIPTION

FIG. 1 is a front elevational view of a wrist strap for rotating cell phone holders, showing my new design;

FIG. 2 is a left side elevational view thereof;

FIG. 3 is a bottom plan view thereof;

FIG. 4 is a rear elevational view thereof;

FIG. 5 is a right side elevational view thereof;

FIG. 6 is a top plan view thereof;

FIG. 7 is a perspective view thereof; and

FIG. 8 is an elevational view thereof showing it mounted on a rotating cell phone holder, with a cell phone and wrist straps shown by the broken lines.

The broken line disclosing a cell phone holder, a cell phone and wrist straps is for illustrative purposes only and forms no part of the claimed design; and,

FIG. 9 is an exploded view thereof: showing a rotating cell phone holder, a cell phone, wrist straps and connecting pins shown by broken lines.

The broken line disclosing a cell phone holder, a cell phone, wrist straps and connecting pins is for illustrative purposes only and forms no part of the claimed design.

1 Claim, 4 Drawing Sheets

