



US00D545493S

(12) **United States Design Patent**
Carter et al.

(10) **Patent No.:** **US D545,493 S**
(45) **Date of Patent:** **** Jun. 26, 2007**

(54) **CIGARETTE PACK FOR TWO LENGTHS OF CIGARETTES**

D432,263 S * 10/2000 Issa D27/191

* cited by examiner

(76) Inventors: **Jeffrey S. Carter**, 220 Country Club, Stansbury Park, UT (US) 84074; **Barry J. Lundy**, 269 Settlers Ct., Tooele, UT (US) 87074

Primary Examiner—Jennifer Rivard
(74) *Attorney, Agent, or Firm*—Donald R. Schoonover

(**) Term: **14 Years**

(57) **CLAIM**

(21) Appl. No.: **29/235,525**

We claim the ornamental design for a cigarette pack for two lengths of cigarettes, as shown and described.

(22) Filed: **Aug. 4, 2005**

DESCRIPTION

(51) **LOC (8) Cl.** **27-06**

FIG. 1 is a perspective view of a cigarette pack for two lengths of cigarettes showing our new design;

(52) **U.S. Cl.** **D27/189**

FIG. 2 is a front elevational view thereof;

(58) **Field of Classification Search** 206/236–242, 206/245, 246, 248, 256–259, 261–275; D27/186, D27/189; D9/430; 229/160.1

FIG. 3 is a rear elevational view thereof;

See application file for complete search history.

FIG. 4 is a top plan view showing the cigarette pack for two lengths of cigarettes in an opened configuration;

(56) **References Cited**

FIG. 5 is a cross-sectional view thereof taken along line 5-5 of FIG. 4;

U.S. PATENT DOCUMENTS

FIG. 6 is a side elevational view thereof, the elevational view of the opposing side being a mirror image thereof; and,

3,039,671	A *	6/1962	Chiamardas	229/160.1
3,234,948	A	2/1966	Stebbins		
3,424,123	A	1/1969	Giffard		
4,081,126	A *	3/1978	Barnard	206/256
4,667,688	A	5/1987	Roig et al.		
5,048,544	A	9/1991	Mascarelli et al.		
5,277,304	A *	1/1994	Brizzi et al.	206/256
5,480,025	A	1/1996	Draucker et al.		

FIG. 7 is a perspective view showing the cigarette pack for two lengths of cigarettes in use in an opened configuration; the broken lines depict environmental structure for illustrative purposes only and form no part of the claimed design.

1 Claim, 1 Drawing Sheet

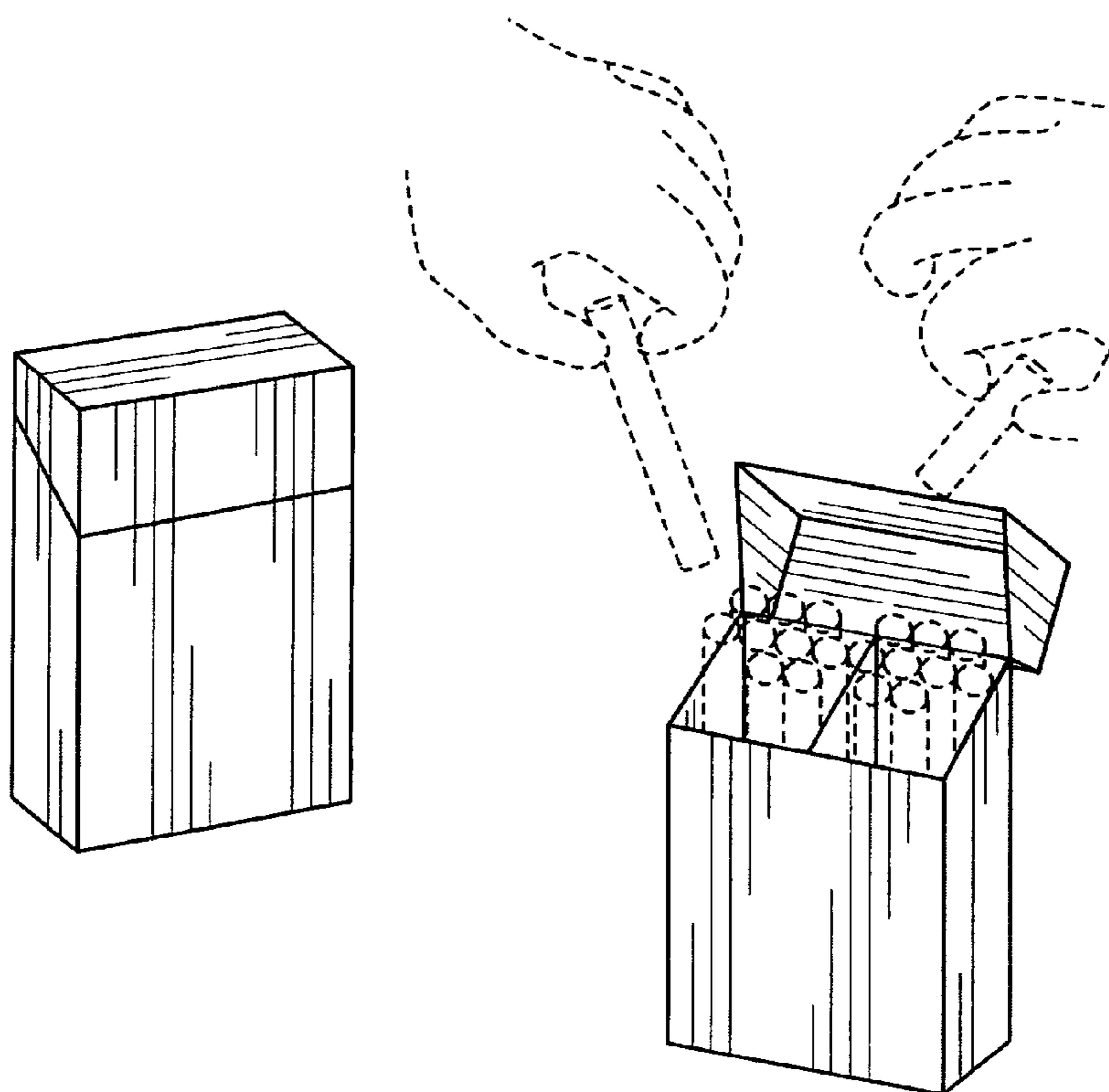

Fig. 1

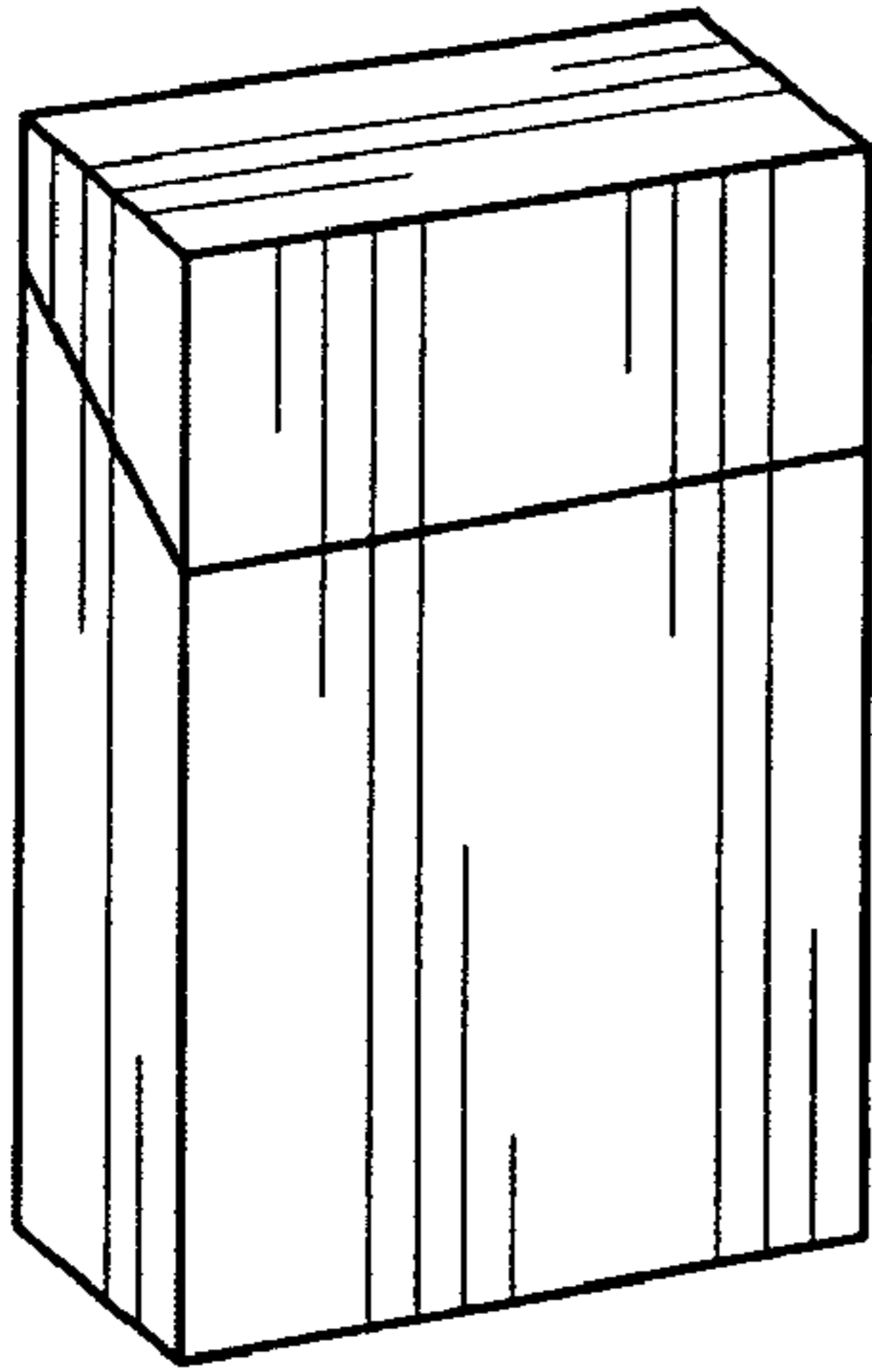

Fig. 2

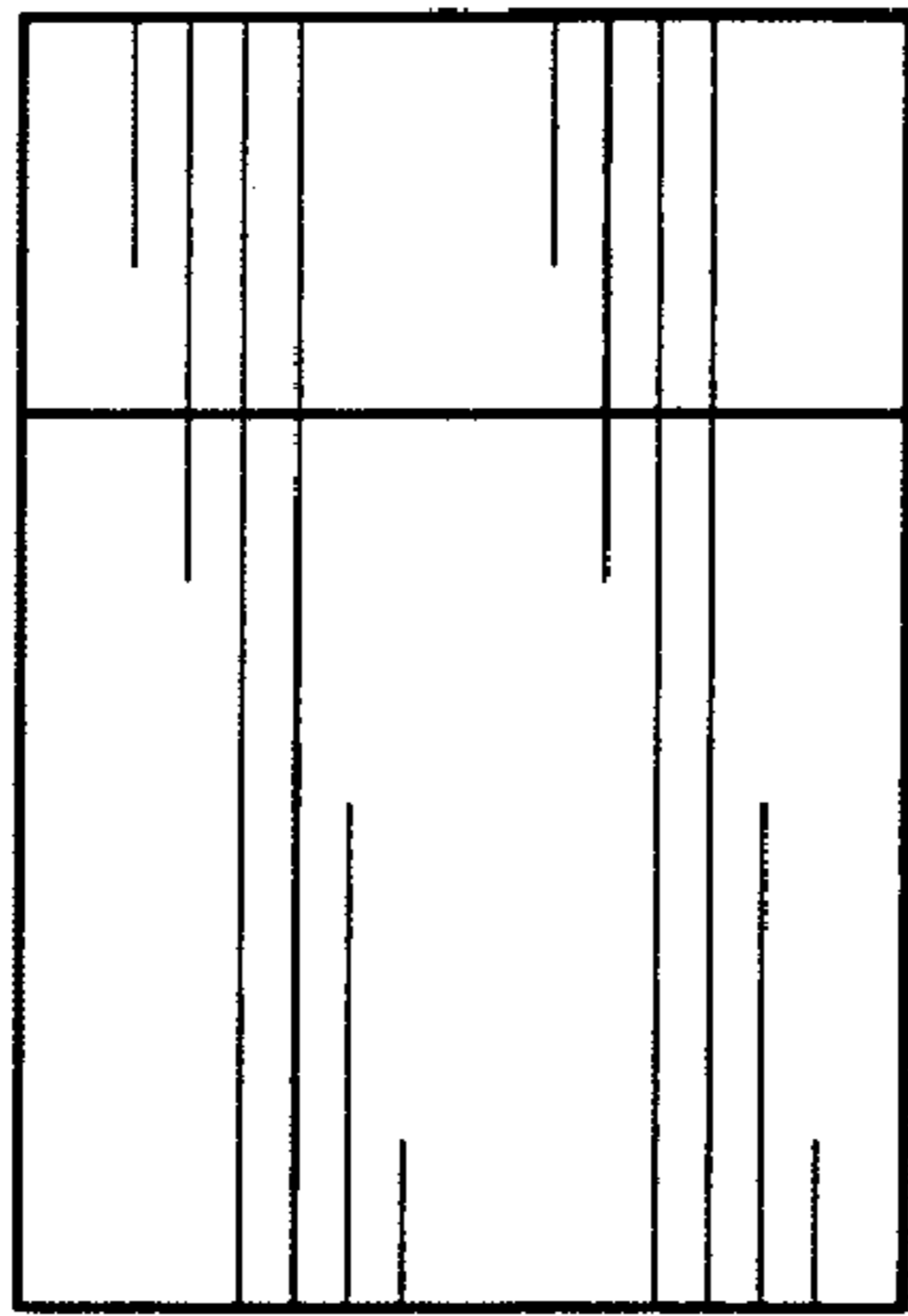

Fig. 3

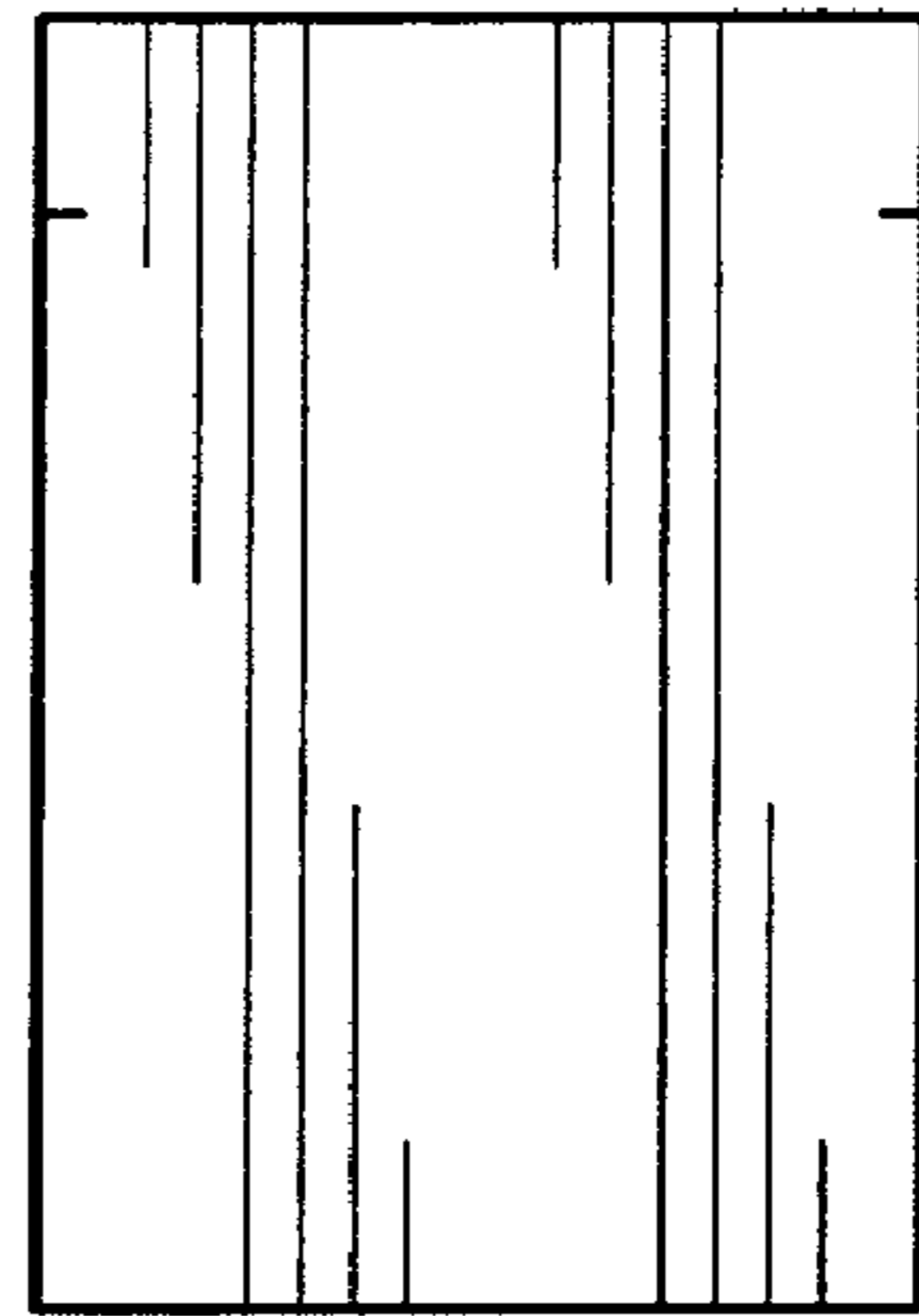

Fig. 4

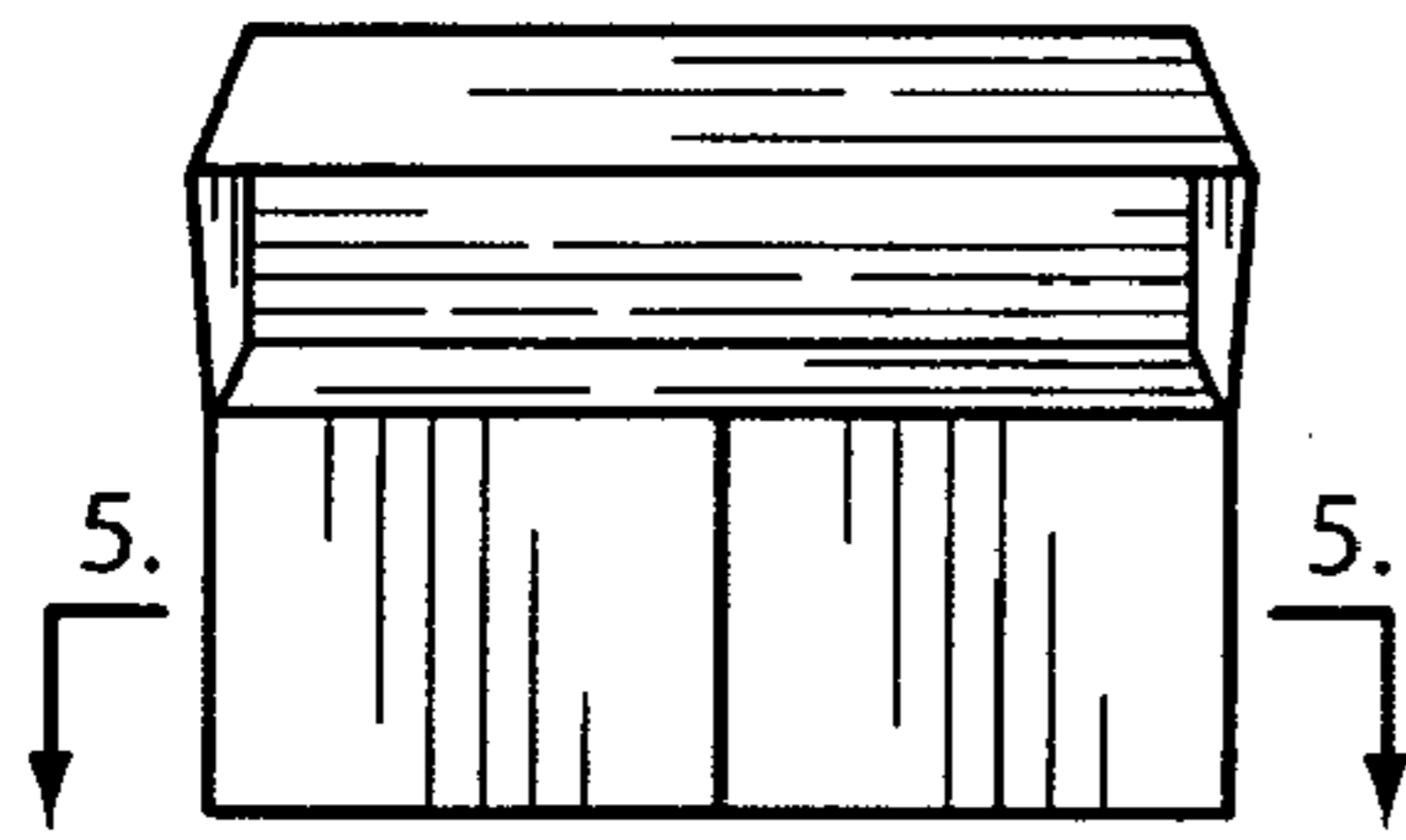

Fig. 7

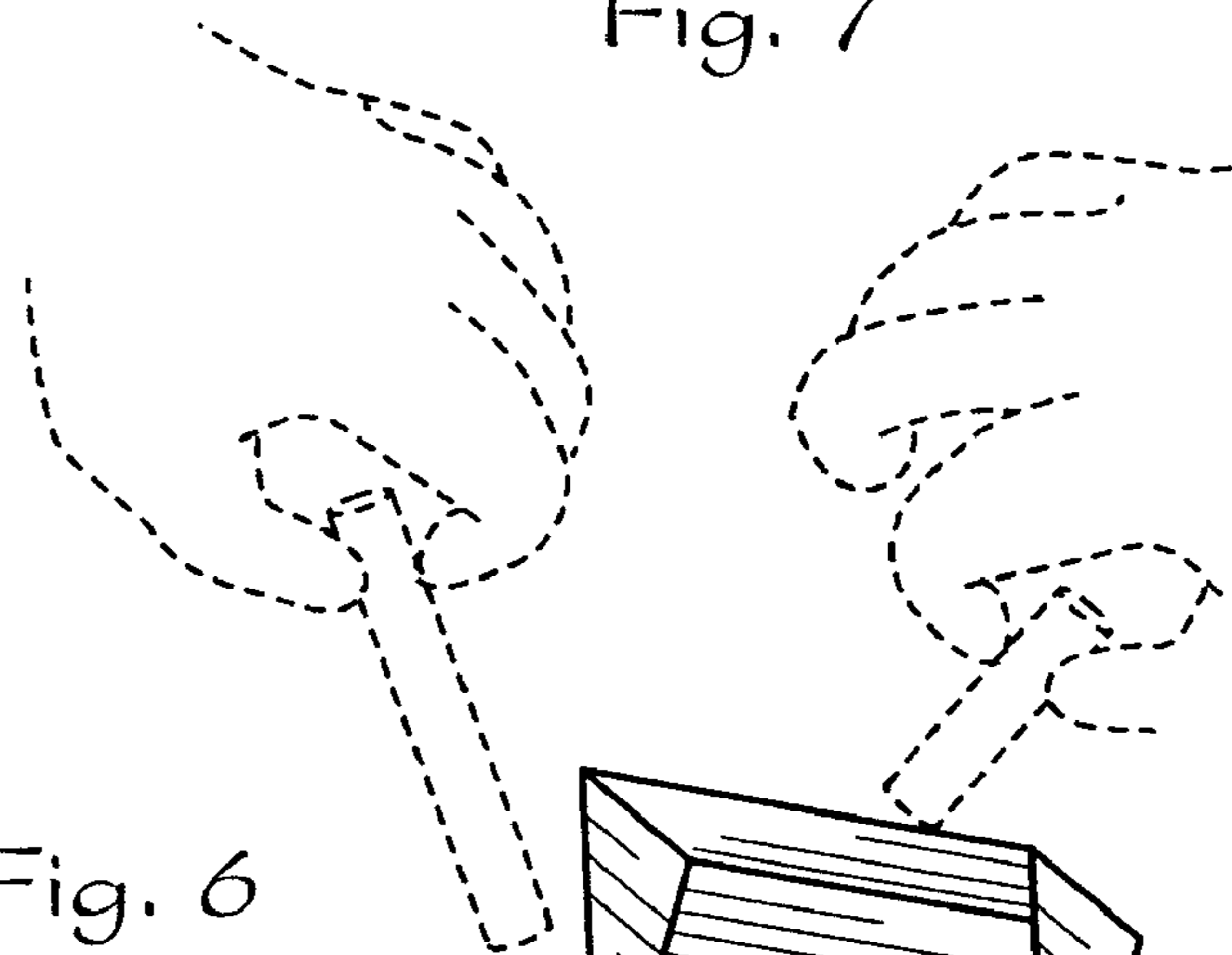

Fig. 5

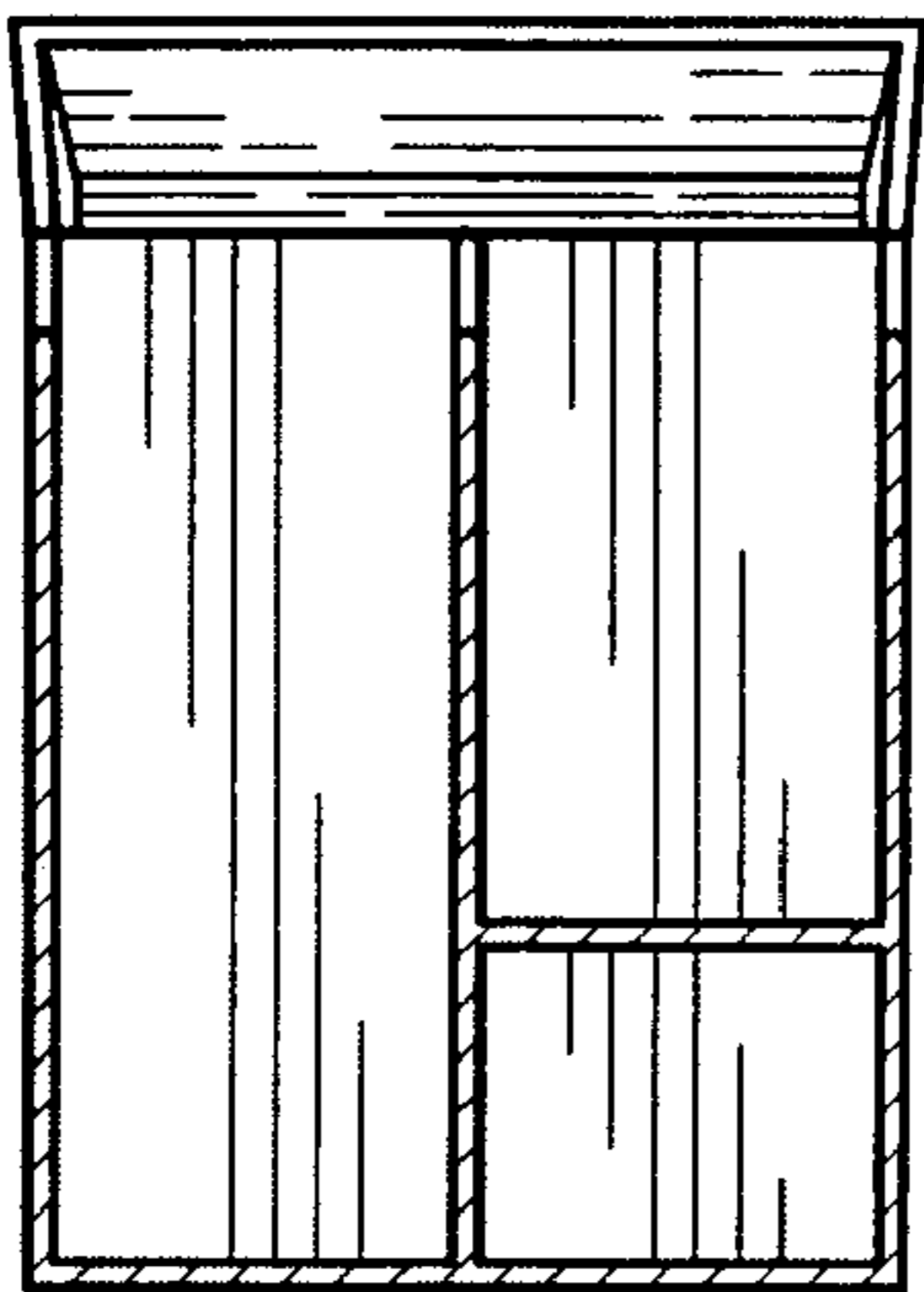

Fig. 6

