

US00D545392S

(12) **United States Design Patent** (10) **Patent No.:** **US D545,392 S**
McKee (45) **Date of Patent:** **** Jun. 26, 2007**

(54) **WATER SPORT BOARD**

(76) Inventor: **William Douglas McKee**, 17
Homelands Avenue, Feilding (NZ)

(**) Term: **14 Years**

(21) Appl. No.: **29/223,301**

(22) Filed: **Feb. 11, 2005**

(30) **Foreign Application Priority Data**

Aug. 13, 2004 (NZ) 405160
Dec. 24, 2004 (NZ) 405687

(51) **LOC (8) Cl.** **21-02**

(52) **U.S. Cl.** **D21/803**

(58) **Field of Classification Search** D21/769-770,
D21/801, 803, 809; 472/128-129; D12/5,
D12/6, 316; 114/253, 346; 441/35, 66, 40-42,
441/129-132

See application file for complete search history.

(56) **References Cited**

U.S. PATENT DOCUMENTS

D187,677 S * 4/1960 Hollington D21/770
D188,094 S * 6/1960 McWethy D32/35
D192,932 S * 5/1962 Gurr D21/828
3,045,264 A * 7/1962 Smith 441/67
3,110,047 A 11/1963 Bringman
3,135,978 A * 6/1964 Grasmoen 441/66
3,335,440 A * 8/1967 Beakbane 441/67
3,380,090 A * 4/1968 Kenmuir 114/357
D226,633 S * 4/1973 Beck D21/69
D228,258 S * 8/1973 McClure D12/316
D232,964 S * 9/1974 Smith D21/769
D276,359 S * 11/1984 Churchill D21/769
4,603,870 A 8/1986 Monreal
4,613,131 A 9/1986 Anderson
4,619,619 A 10/1986 Muse, Jr.
4,669,992 A 6/1987 Morris
D306,631 S * 3/1990 Aguilar et al. D21/769
D349,743 S * 8/1994 Hare D21/803

D397,286 S * 8/1998 Dreyfus et al. D8/358
5,846,108 A 12/1998 Milford
D407,779 S * 4/1999 Peterson D21/803
D414,235 S * 9/1999 Peterson D21/803
D432,199 S * 10/2000 Peterson D21/803
6,247,984 B1 * 6/2001 Hatcher 441/66
D462,406 S * 9/2002 Kessler D21/769
D473,161 S * 4/2003 Inkster D12/5
6,648,707 B1 * 11/2003 Peterson 441/66

FOREIGN PATENT DOCUMENTS

DE 2624401 12/1977
JP 173084 A 12/2000
NZ 24234 12/1991
NZ 27779 8/1996
NZ 29868 12/1998
WO 9917984 4/1999
WO 2005028294 3/2005
WO 2005079934 9/2005

* cited by examiner

Primary Examiner—Janice Seeger

Assistant Examiner—Zenia Bennett

(74) *Attorney, Agent, or Firm*—Dann, Dorfman, Herrell and Skillman, P.C.

(57) **CLAIM**

The ornamental design for a water sport board, as shown and described.

DESCRIPTION

FIG. 1 is a top plan view of the water sport board;
FIG. 2 is a top front perspective view thereof;
FIG. 3 is a front left side perspective view thereof;
FIG. 4 is a top rear perspective view thereof;
FIG. 5 is a side elevation view thereof; and,
FIG. 6 is a bottom plan view thereof.

The broken lines are for environmental purposes only and form no part of the claimed design.

1 Claim, 6 Drawing Sheets

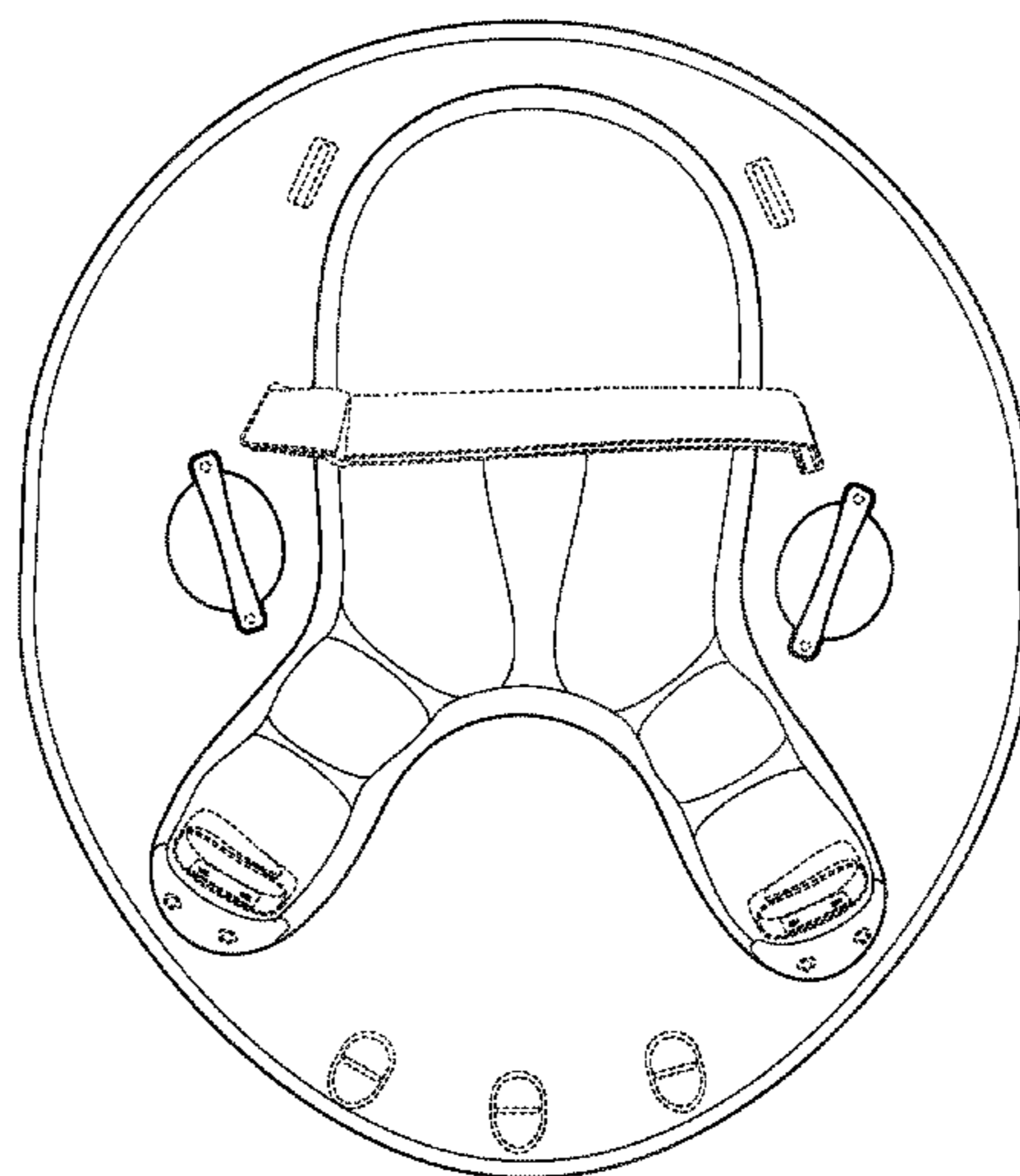

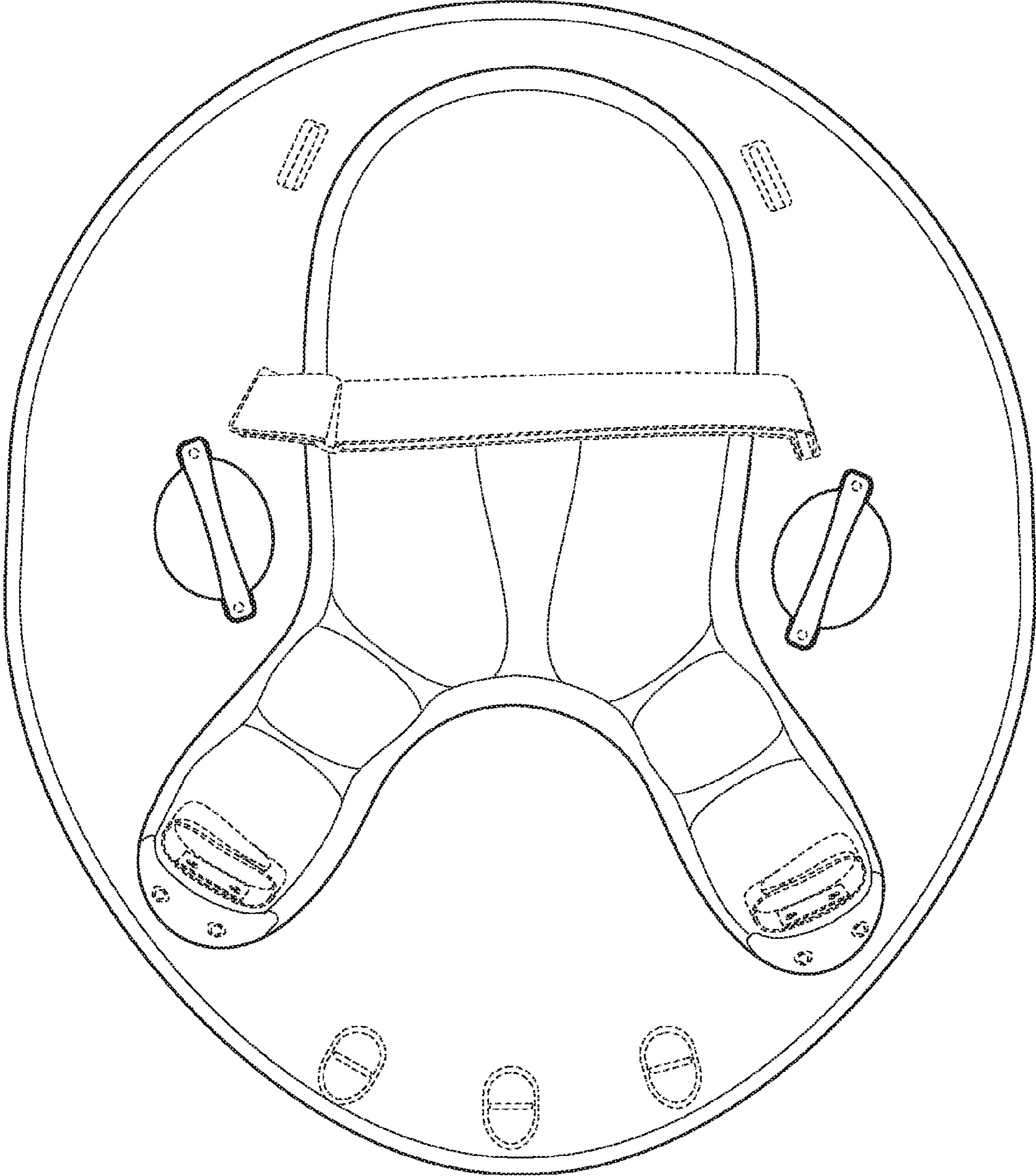

FIG. 1

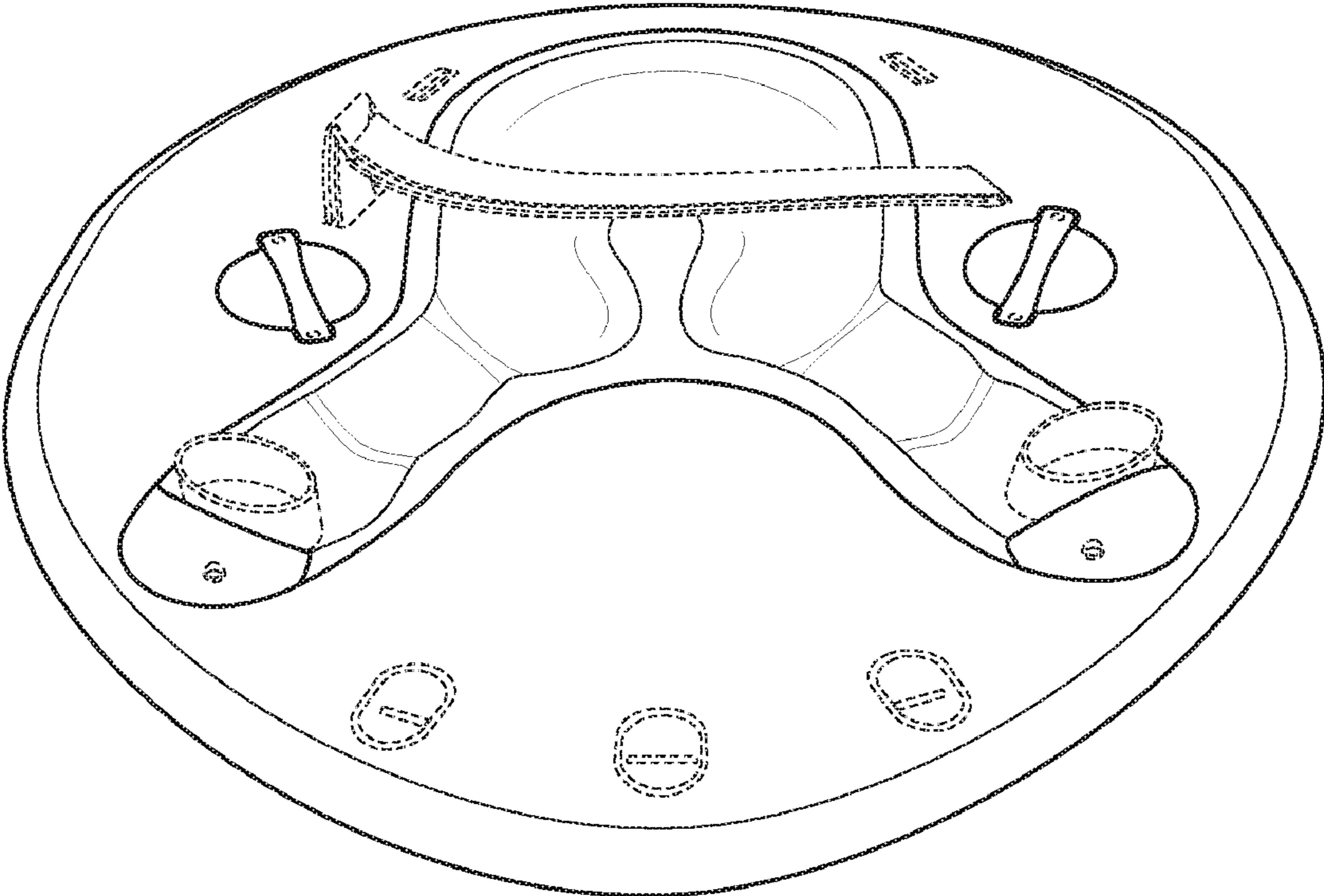

FIG. 2

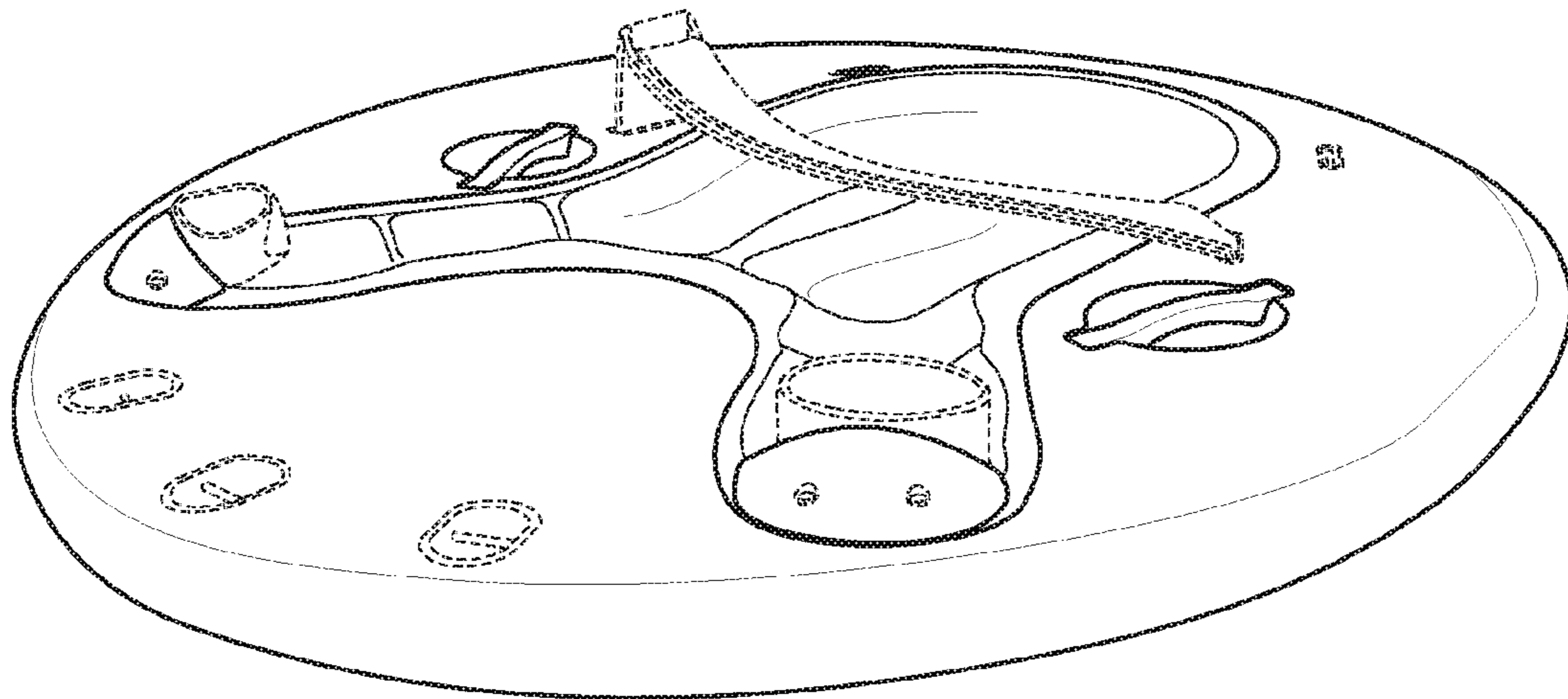

FIG. 3

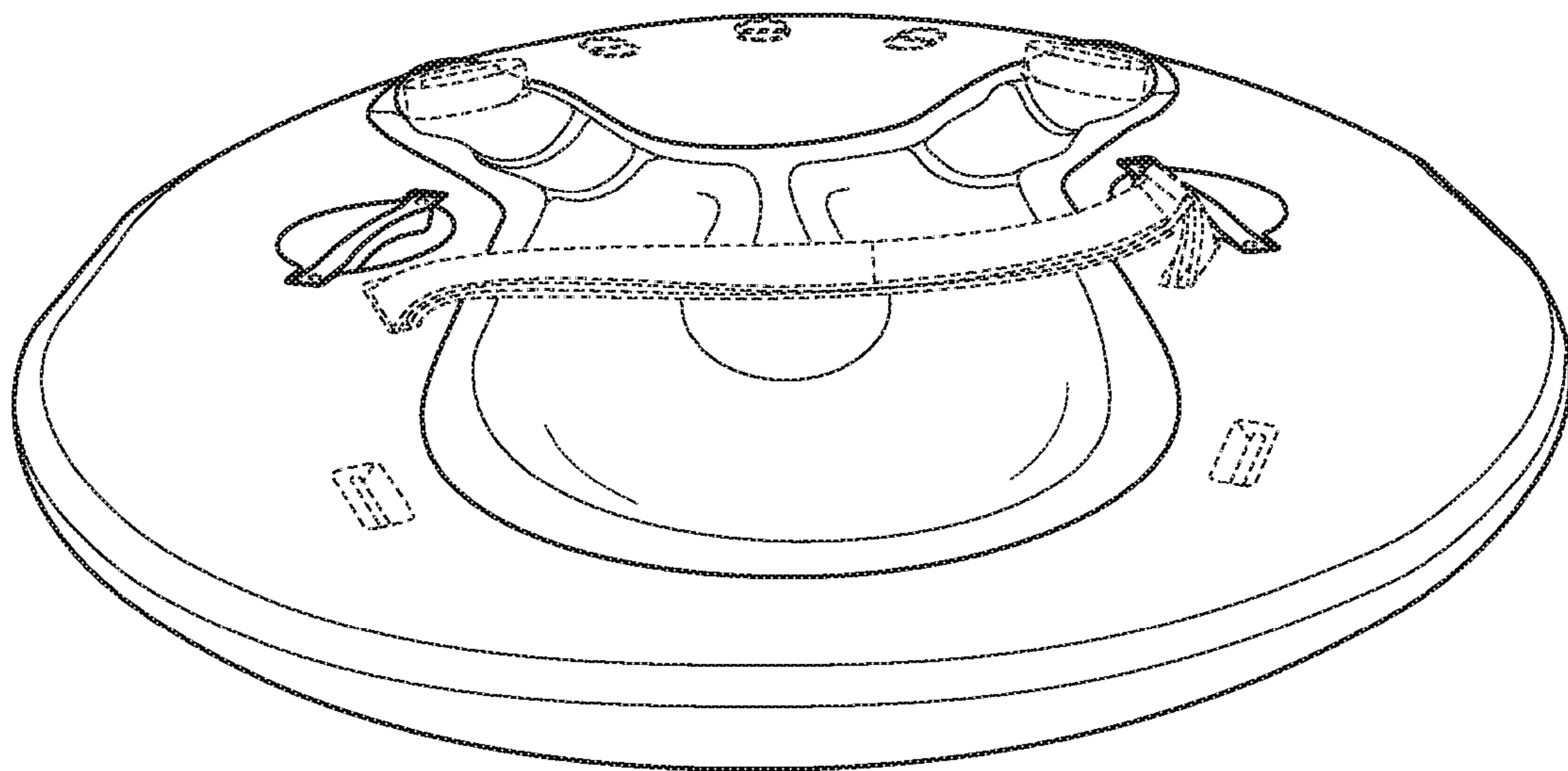

FIG. 4

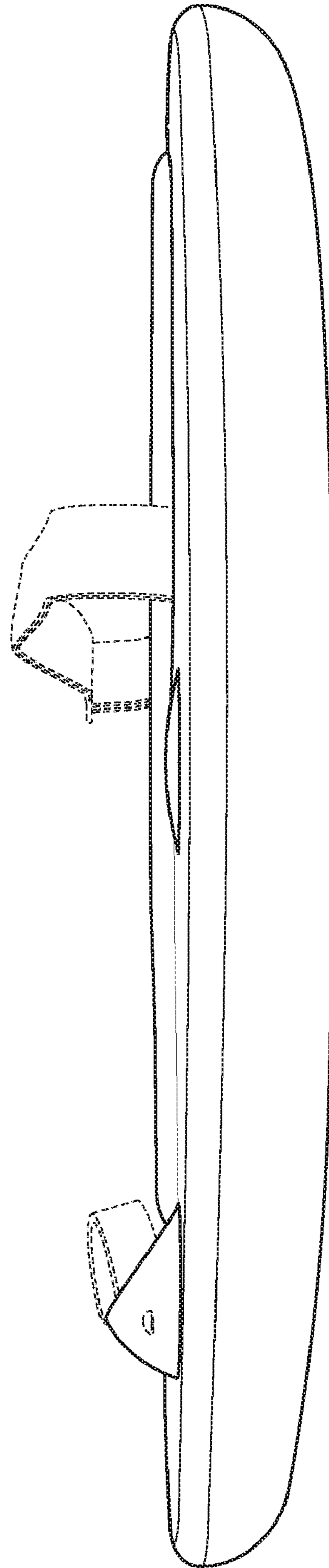

FIG. 5

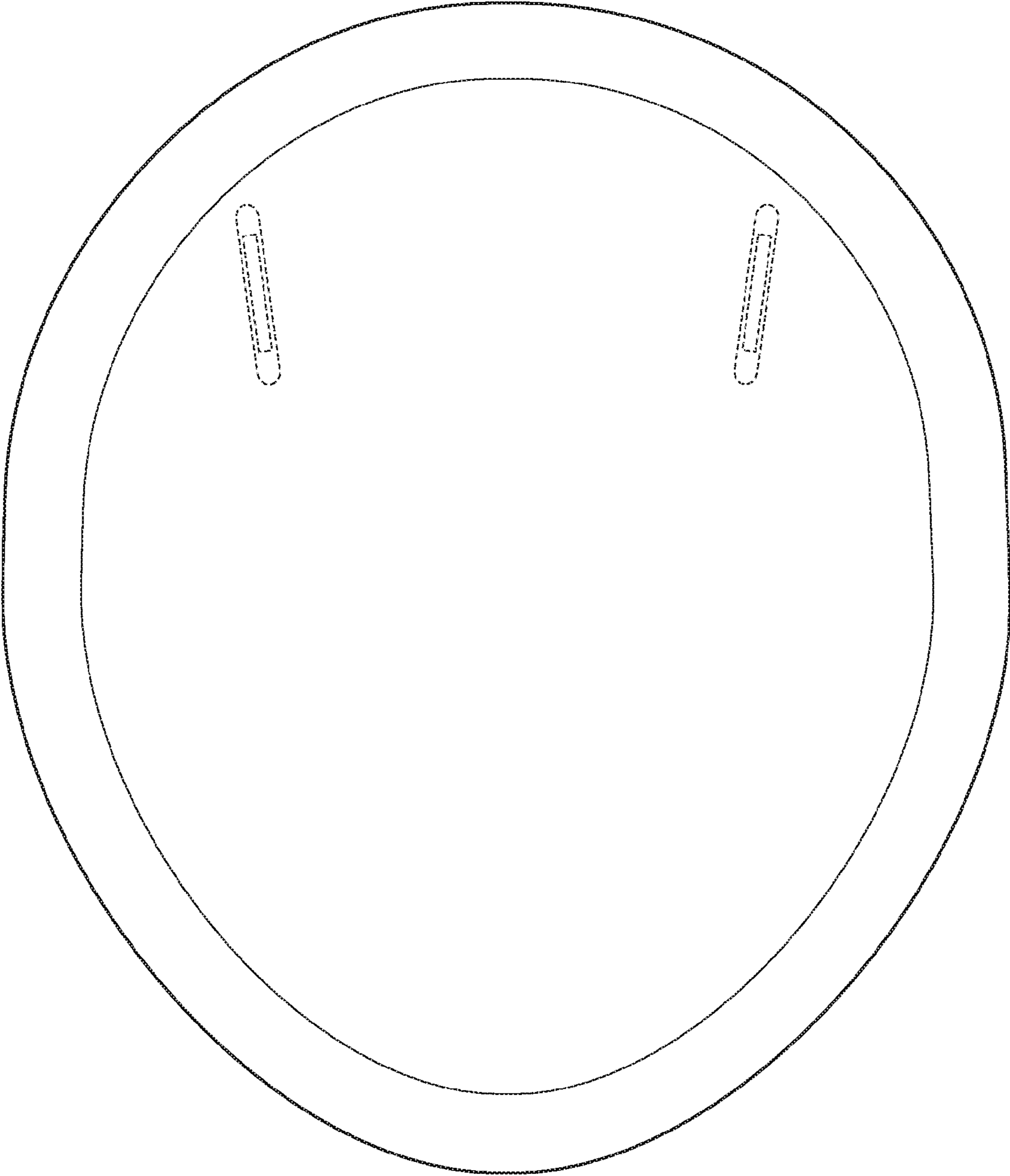

FIG. 6