



US00D545319S

(12) **United States Design Patent**  
**Griffin**

(10) **Patent No.:** **US D545,319 S**

(45) **Date of Patent:** **\*\* Jun. 26, 2007**

(54) **DESKTOP STAND FOR SUPPORTING A WIRELESS TRANSMITTING OR RECEIVING UNIT**

(76) Inventor: **Paul Griffin**, 2846 Polo Club Rd., Nashville, TN (US) 37221

(\*\*) Term: **14 Years**

(21) Appl. No.: **29/238,957**

(22) Filed: **Sep. 23, 2005**

(51) **LOC (8) Cl.** ..... **14-02**

(52) **U.S. Cl.** ..... **D14/434**

(58) **Field of Classification Search** ..... D14/142, D14/149, 217, 251, 432, 434, 435, 447, 496; D13/107, 108, 118; 248/221.11, 309.1; 320/107, 320/110, 113–115; 361/600, 679, 683, 686; 439/529, 534; 455/556.1, 556.2, 557  
See application file for complete search history.

(56) **References Cited**

**U.S. PATENT DOCUMENTS**

D361,979 S *	9/1995	Shirakawa et al.	.....	D14/149
D368,892 S *	4/1996	Tanaka	.....	D13/108
D414,742 S *	10/1999	Chang	.....	D13/107
D436,576 S *	1/2001	Herrmann et al.	.....	D13/108
D448,724 S *	10/2001	Hsiao	.....	D13/107
D466,476 S *	12/2002	Stratford	.....	D13/108
D467,866 S *	12/2002	Hsiao	.....	D13/107
D529,440 S *	10/2006	Lodato et al.	.....	D13/108

**OTHER PUBLICATIONS**

Griffin Technology, [www.GriffinTechnology.com/products/airbase](http://www.GriffinTechnology.com/products/airbase), Mar. 27, 2007, 4 pgs.\*

\* cited by examiner

*Primary Examiner*—Stella Reid

*Assistant Examiner*—Keli' L. Acker

(74) *Attorney, Agent, or Firm*—Michael E. McKee

(57) **CLAIM**

The ornamental design for a desktop stand for supporting a wireless transmitting or receiving unit, as shown and described.

**DESCRIPTION**

FIG. 1 is a perspective view of a desktop stand for supporting a wireless transmitter or receiver, showing my new design;

FIG. 2 is a top view thereof;

FIG. 3 is a front elevational view thereof;

FIG. 4 is a right side elevational view thereof, the left side elevational view being a mirror image thereof;

FIG. 5 is a back elevational view thereof;

FIG. 6 is a bottom view thereof; and,

FIG. 7 is a perspective view thereof, with the broken line showing of the wireless transmitting unit included for the purpose of illustrating environmental structure and forming no part of the claimed design.

**1 Claim, 4 Drawing Sheets**

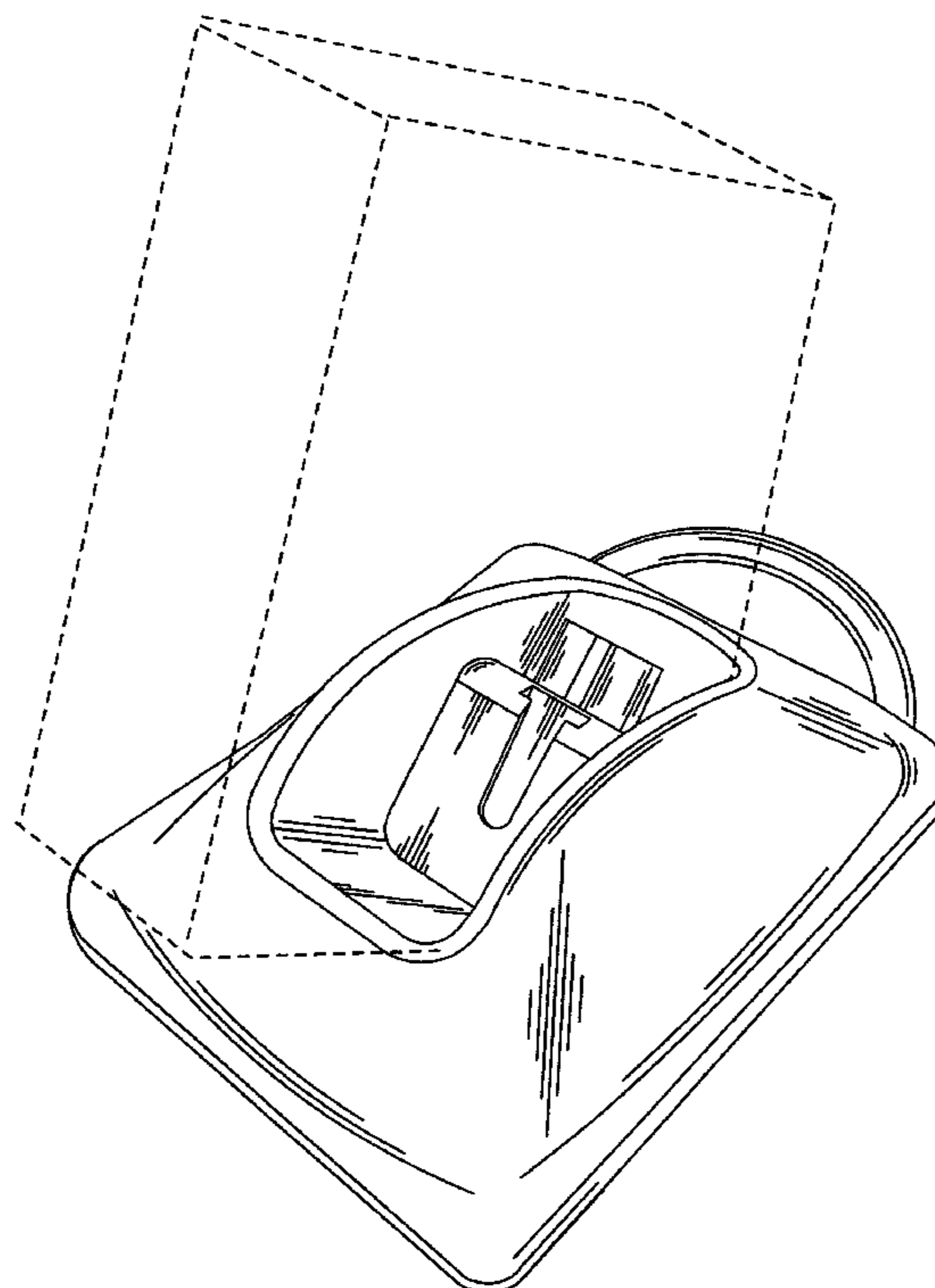

FIG. 1

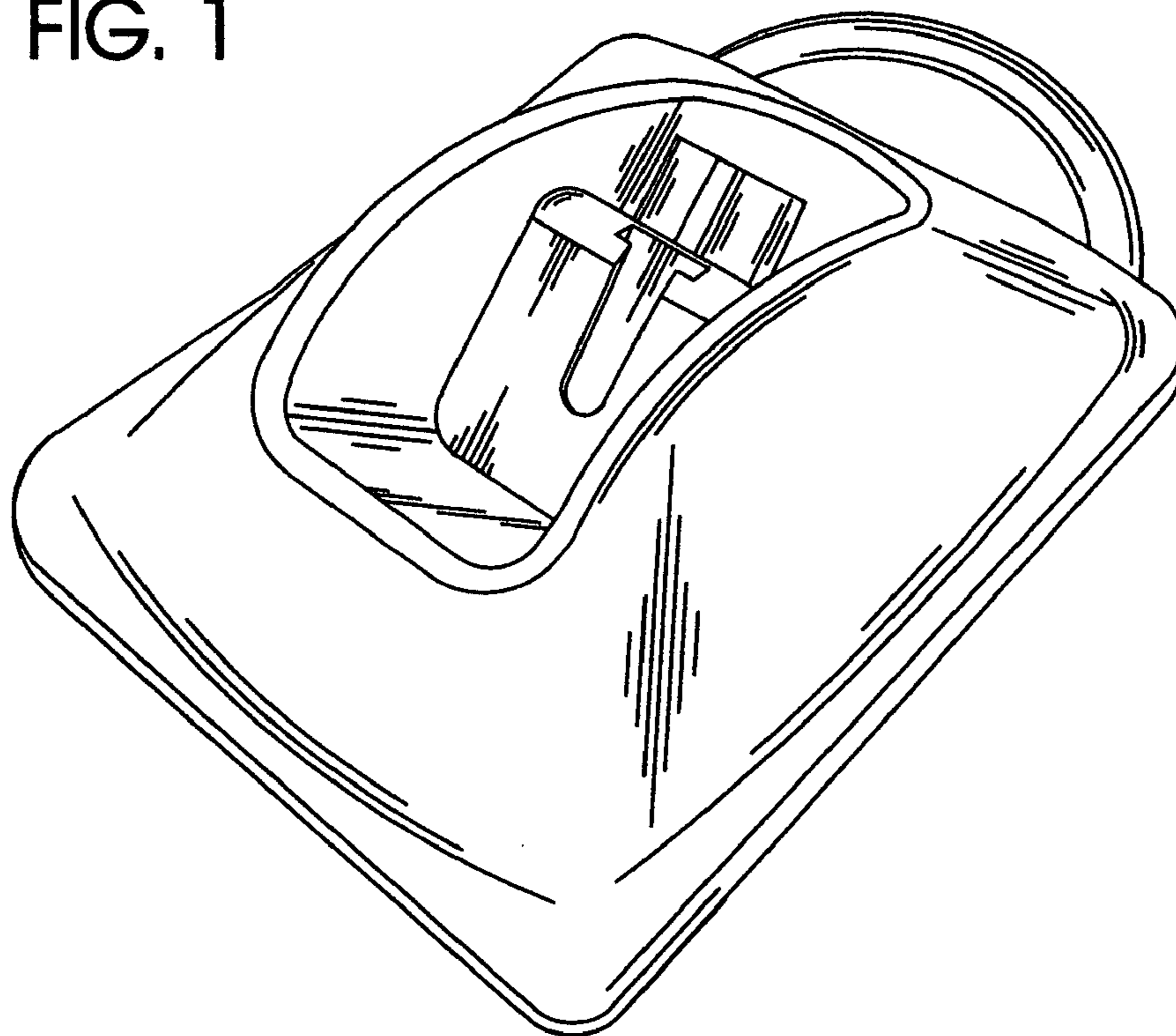

FIG. 2

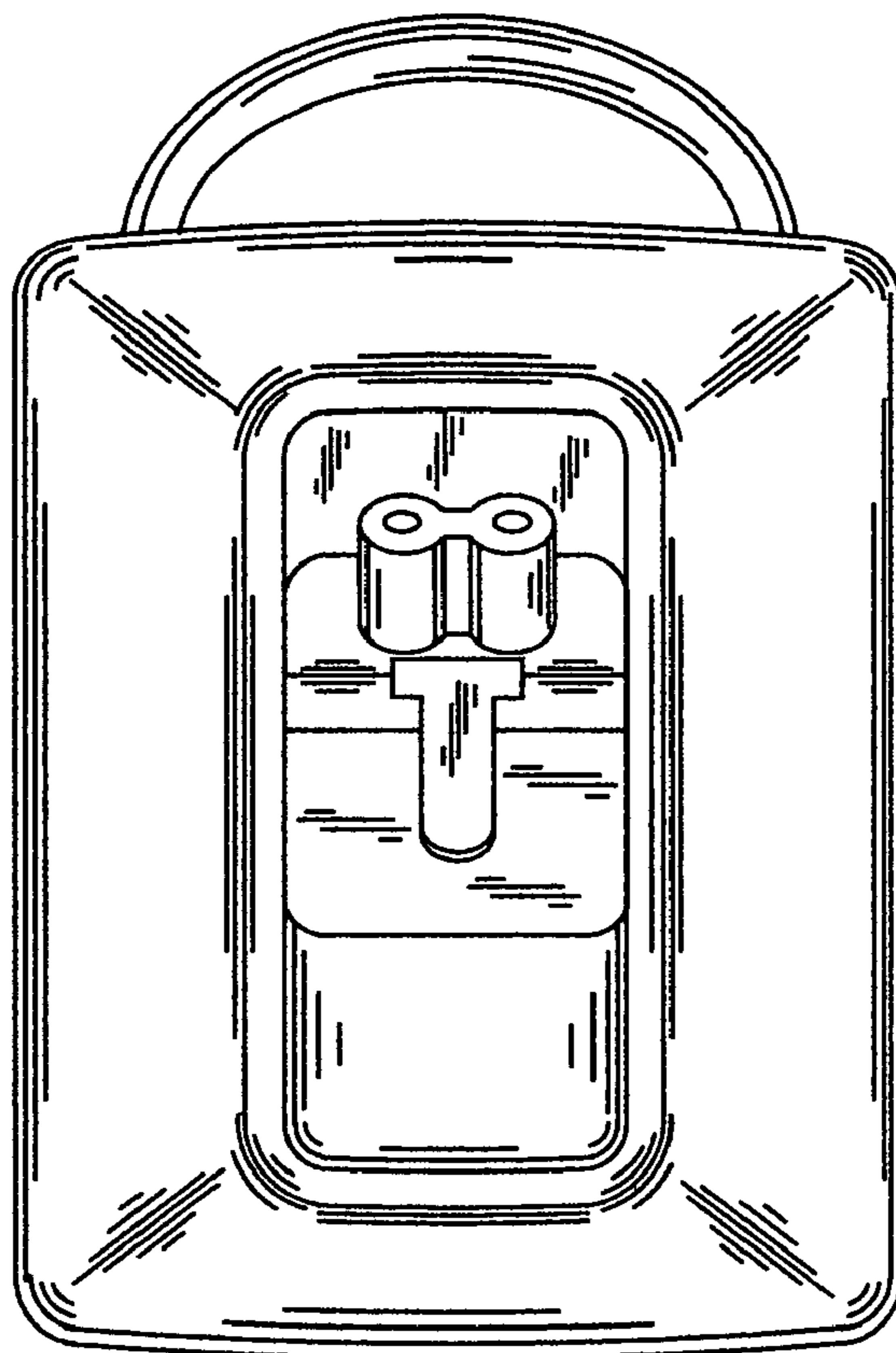

FIG. 3

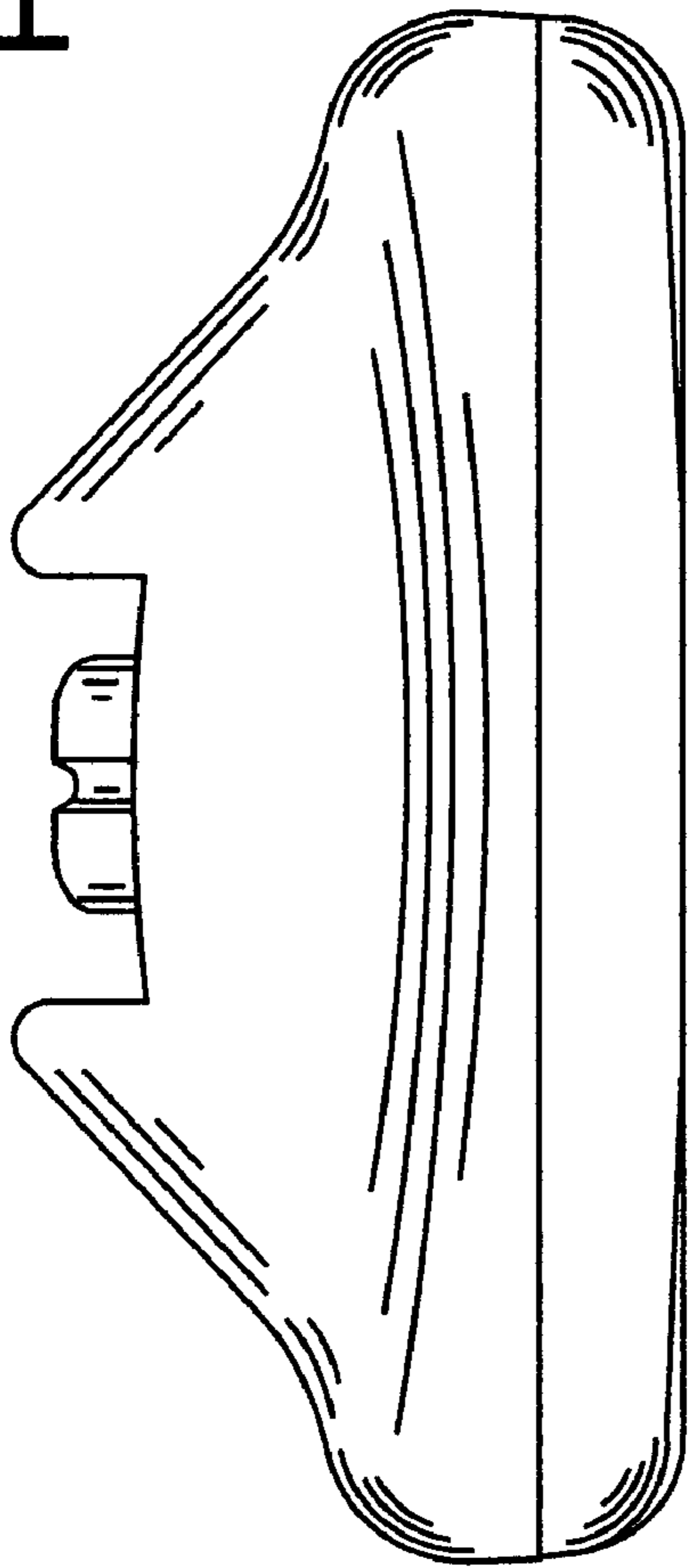
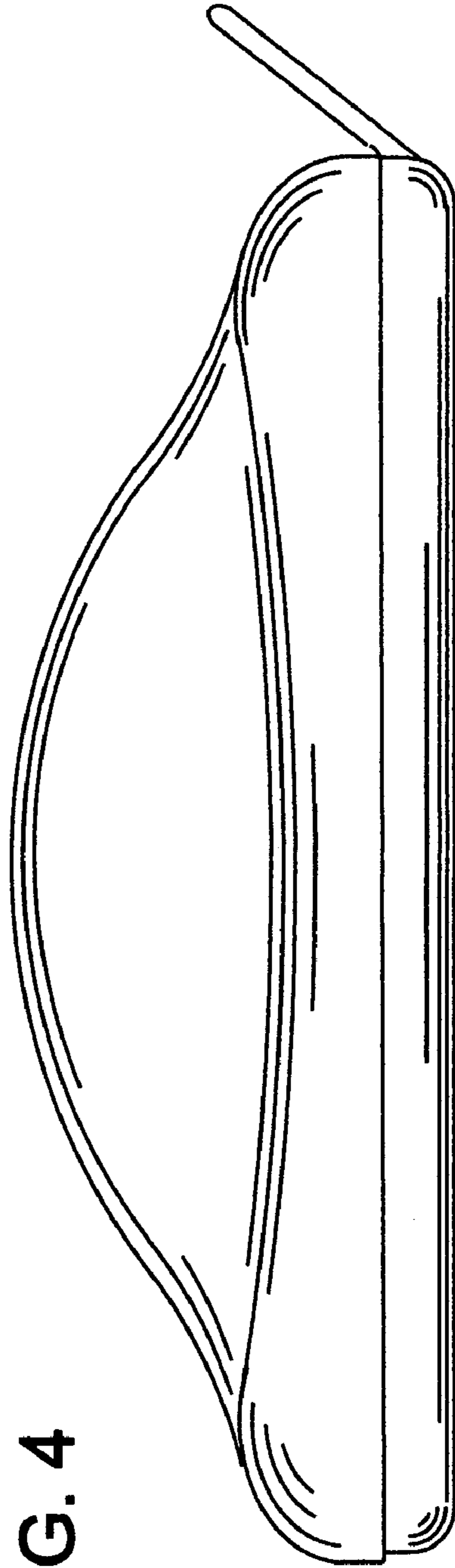

FIG. 4



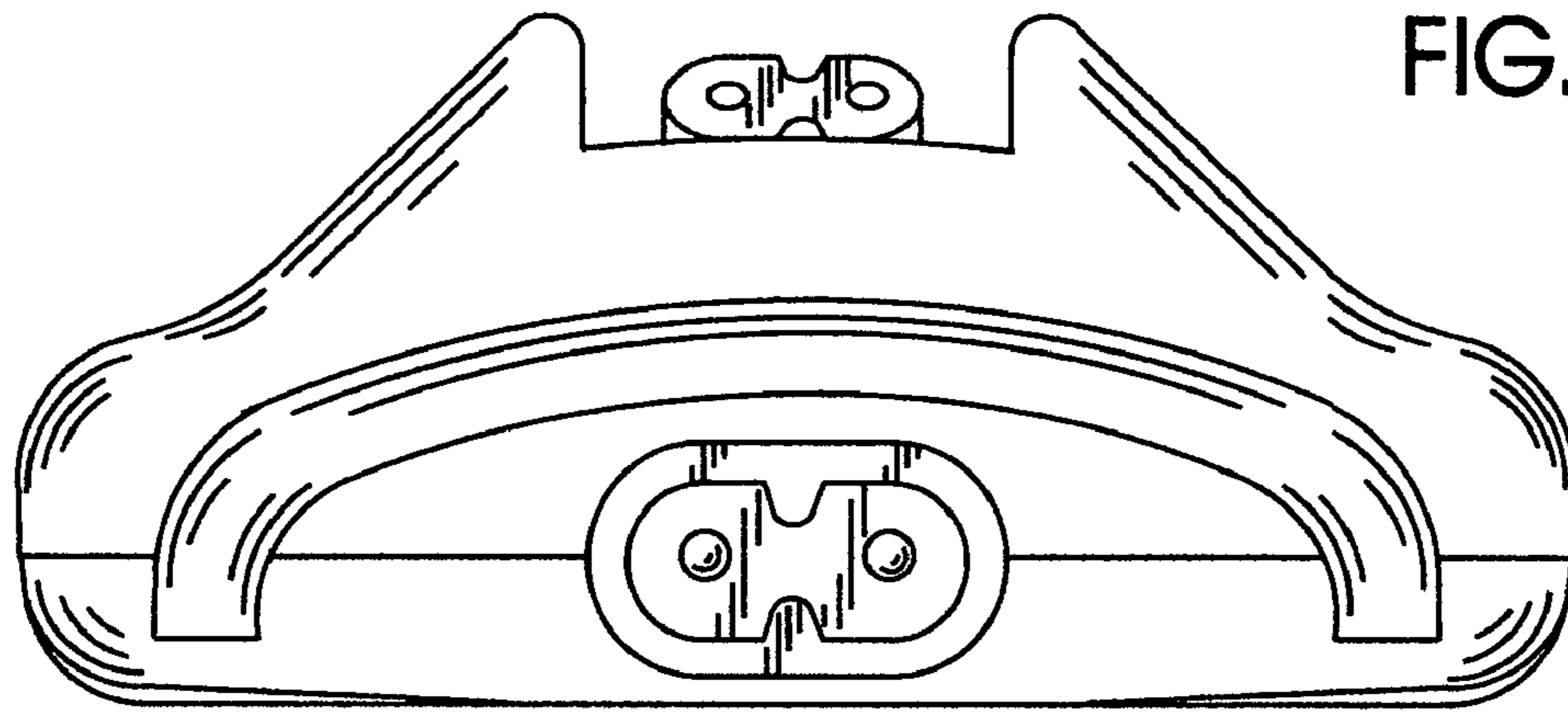

FIG. 5

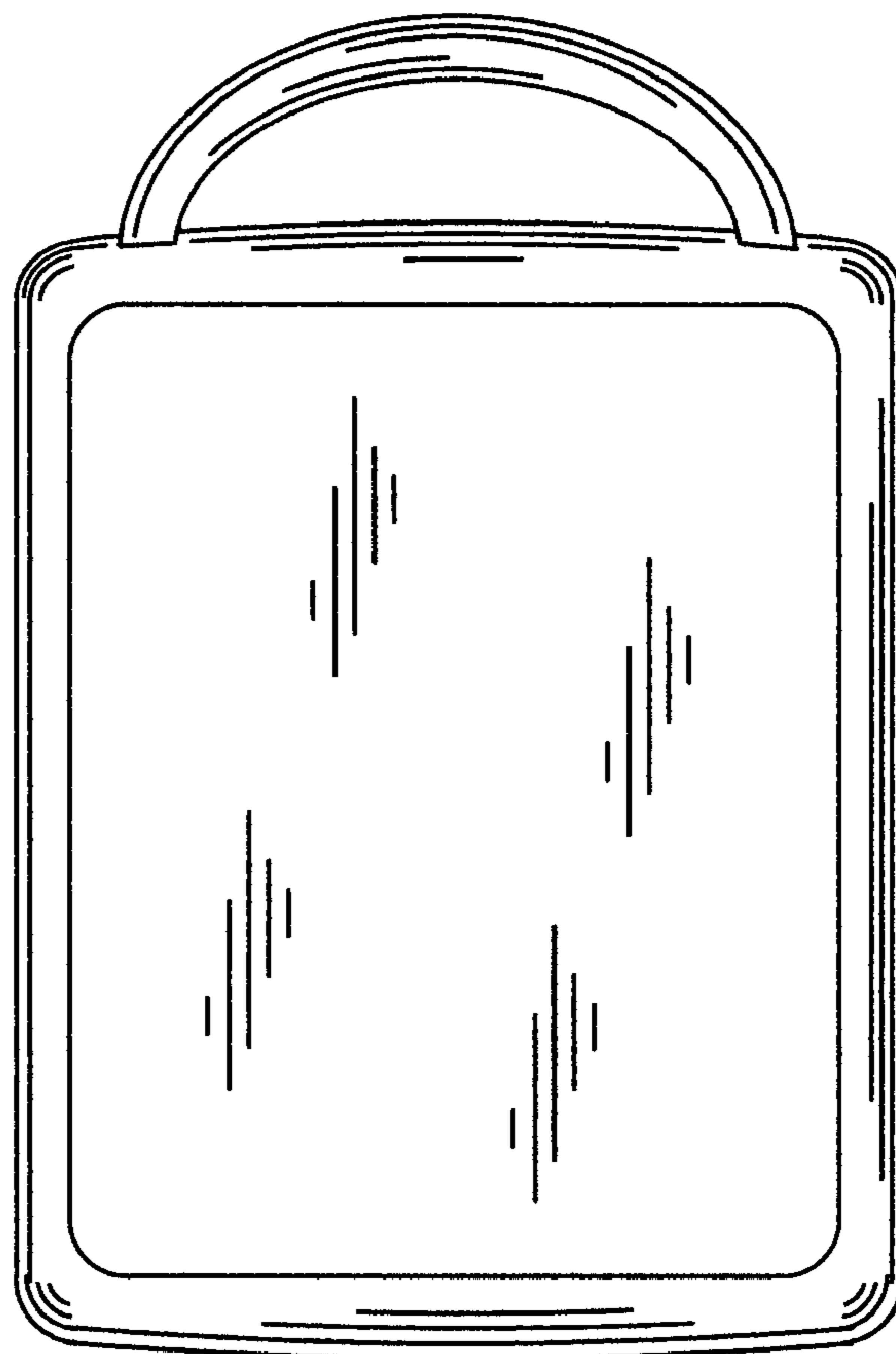

FIG. 6

FIG. 7

