



US00D545287S

(12) **United States Design Patent**
Han et al.

(10) **Patent No.:** **US D545,287 S**
(45) **Date of Patent:** **** Jun. 26, 2007**

(54) **PORTABLE PHONE**

D519,966 S * 5/2006 Salmi et al. D14/138
2002/0173340 A1* 11/2002 Watanabe 455/556

(75) Inventors: **Woo-Seung Han**, Seoul (KR);
Yoon-Young Cho, Seoul (KR);
Chang-Hwan Hwang, Goyang-si (KR)

(Continued)

FOREIGN PATENT DOCUMENTS

(73) Assignee: **Samsung Electronics Co., Ltd.**,
Suwon-Si (KR)

WO DM/067801 * 4/2006
WO DM/068244 * 6/2006

OTHER PUBLICATIONS

(**) Term: **14 Years**

Samsung D300 telephone, announced Feb. 2006, [online],
[retrieved on Feb. 2, 2007]. Retrieved from Internet, <URL:http://
www.gsmarena.com>.*

(21) Appl. No.: **29/241,449**

Haier N60 telephone, announced 1st Q 2005, [online], [retrieved on
Feb. 4, 2007]. Retrieved from Internet, <URL:http://www.
gsmarena.com>.*

(22) Filed: **Oct. 28, 2005**

Samsung D550 telephone, announced Jun. 2005, [online], [retrieved
on Feb. 4, 2007]. Retrieved from Internet, <URL:http://www.
gsmarena.com>.*

(30) **Foreign Application Priority Data**

Apr. 28, 2005 (KR) 30-2005-0014431

(51) **LOC (8) Cl.** **14-03**

Primary Examiner—Jeffrey Asch

(52) **U.S. Cl.** **D14/138**

(74) *Attorney, Agent, or Firm*—Staas & Halsey LLP

(58) **Field of Classification Search** D14/191,
D14/138, 147–148, 247–248, 144, 496, 156,
D14/341–347; 379/433.01–433.13; 455/575.3,
455/566, 575.1, 556.1, 556.2, 90.3; D21/517;
D16/208

(57) **CLAIM**

See application file for complete search history.

The ornamental design for the portable phone, as shown and
described.

DESCRIPTION

(56) **References Cited**

U.S. PATENT DOCUMENTS

5,923,751 A * 7/1999 Ohtsuka et al. 379/433.13
D476,303 S * 6/2003 Lee et al. D14/138
D486,809 S * 2/2004 Hwang D14/138
D488,453 S * 4/2004 Chang et al. D14/138
6,728,557 B1 * 4/2004 Tracy et al. 455/575.3
6,744,890 B1 * 6/2004 Le et al. 379/433.07
D495,672 S * 9/2004 Jeon et al. D14/138
D498,734 S * 11/2004 Joung D14/138
6,882,726 B2 * 4/2005 Kim 279/433.13
D508,036 S * 8/2005 Wada D14/138
D508,685 S * 8/2005 Kim et al. D14/138
D510,922 S * 10/2005 Kim et al. D14/138
D513,244 S * 12/2005 Kim et al. D14/138
D518,467 S * 4/2006 Kim et al. D14/138

FIG. 1 is a perspective view of the portable phone showing
our design;

FIG. 2 is a front view thereof;

FIG. 3 is a rear view thereof;

FIG. 4 is a left side view thereof;

FIG. 5 is a right side view thereof;

FIG. 6 is a top plan view thereof;

FIG. 7 is a bottom plan view thereof;

FIG. 8 is a front, open view thereof; and,

FIG. 9 is a front view thereof with the front cover rotated to
another, alternate open position.

1 Claim, 6 Drawing Sheets

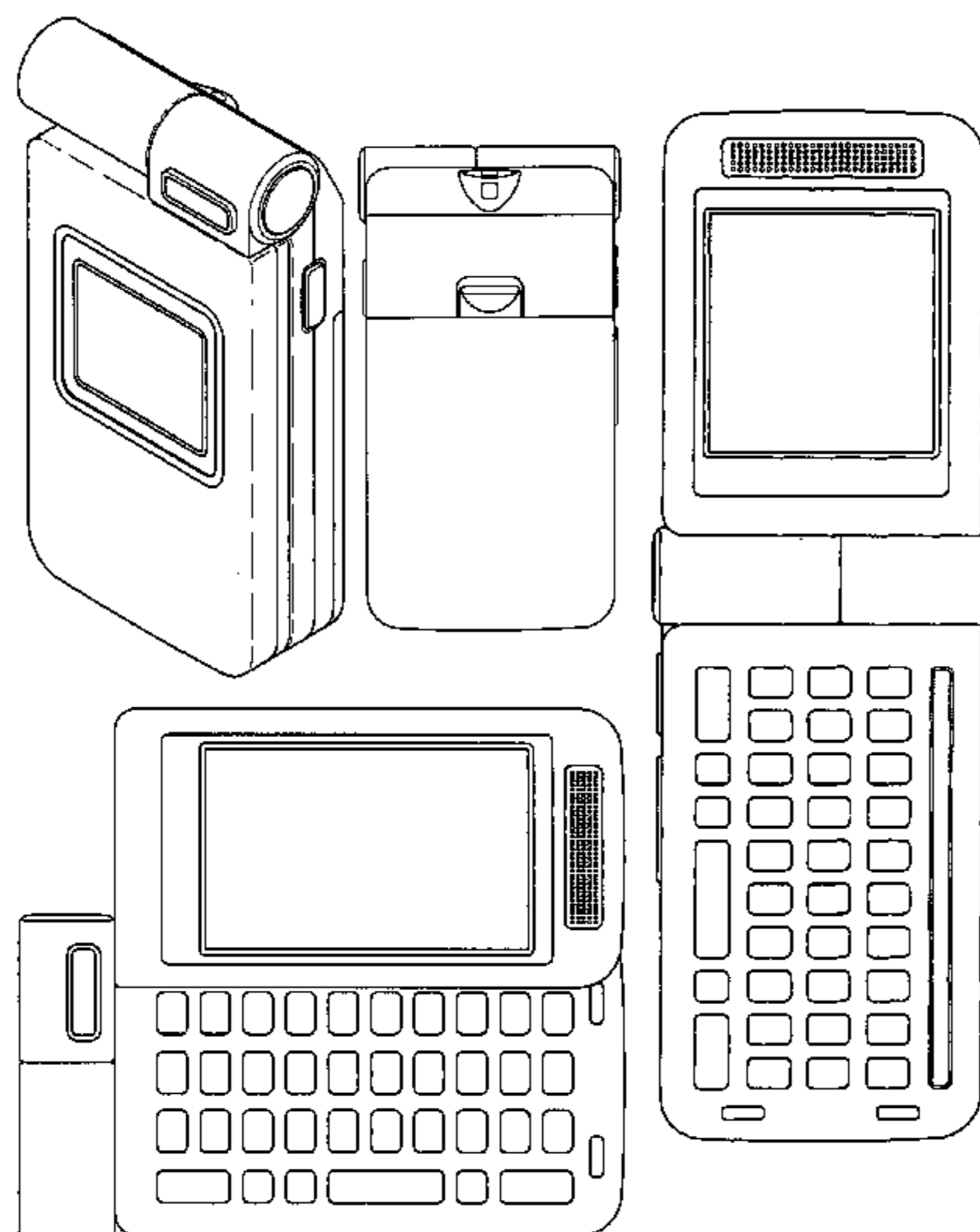

US D545,287 S

Page 2

U.S. PATENT DOCUMENTS

| | | | | | | | | | | | |
|--------------|-----|---------|-------------|-------|-----------|--------------|-----|---------|-----------------|-------|-----------|
| 2004/0058724 | A1* | 3/2004 | Choi | | 455/575.7 | 2005/0261041 | A1* | 11/2005 | Im | | 455/575.3 |
| 2004/0097262 | A1* | 5/2004 | Lee | | 455/556.1 | 2005/0282596 | A1* | 12/2005 | Park et al. | | 455/575.3 |
| 2004/0185920 | A1* | 9/2004 | Choi et al. | | 455/575.1 | 2006/0019728 | A1* | 1/2006 | Sakamoto et al. | | 455/575.3 |
| 2004/0203535 | A1* | 10/2004 | Kim et al. | | 455/90.3 | 2006/0135225 | A1* | 6/2006 | Lin et al. | | 455/575.3 |
| 2004/0224732 | A1* | 11/2004 | Lee et al. | | 455/575.3 | 2006/0135226 | A1* | 6/2006 | Won et al. | | 455/575.3 |
| 2005/0113156 | A1* | 5/2005 | Park et al. | | 455/575.4 | 2006/0148542 | A1* | 7/2006 | Oliver | | 455/575.3 |
| 2005/0245296 | A1* | 11/2005 | Hong et al. | | 455/575.3 | | | | | | |

* cited by examiner

FIG. 1

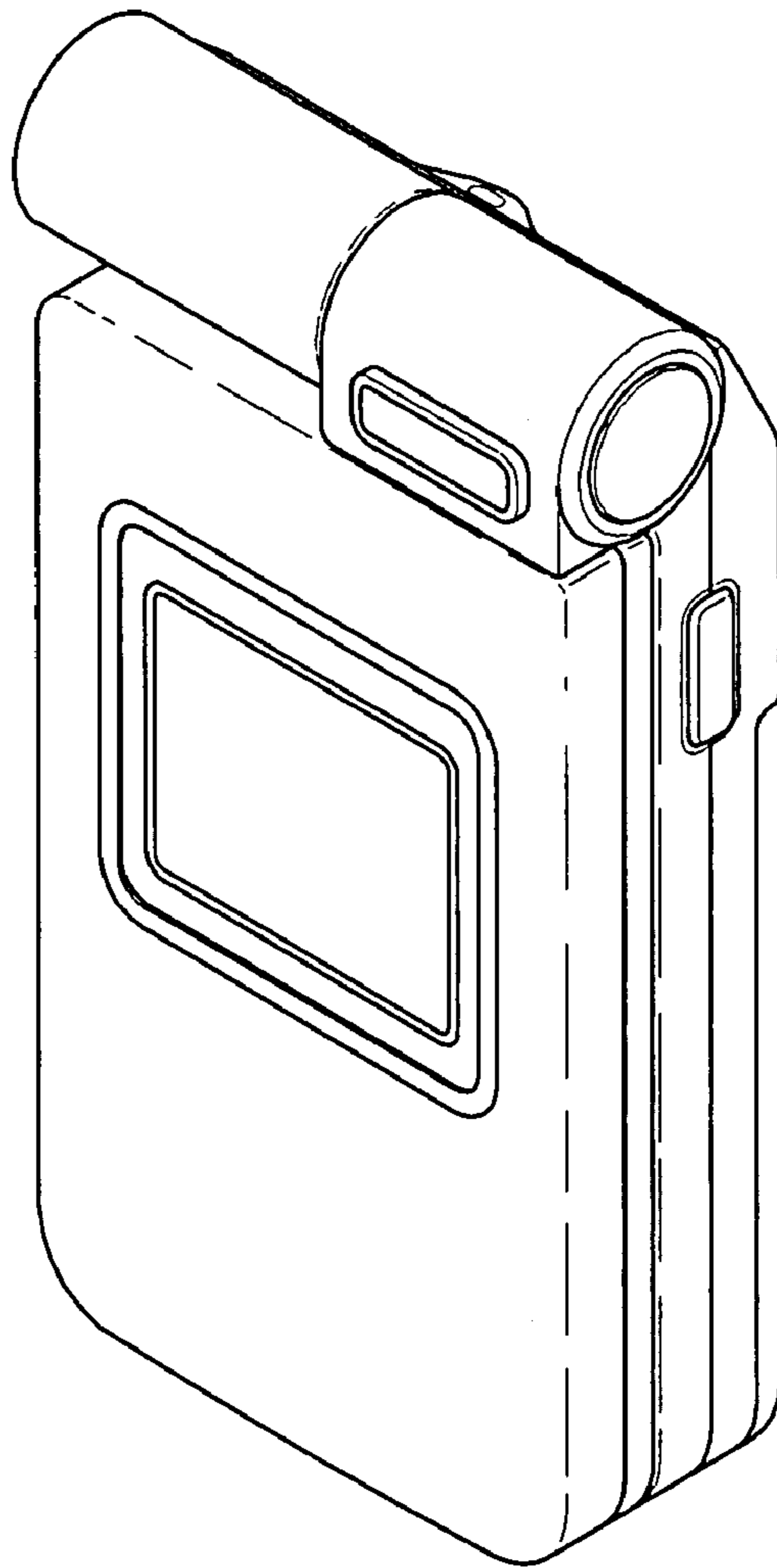

FIG. 2

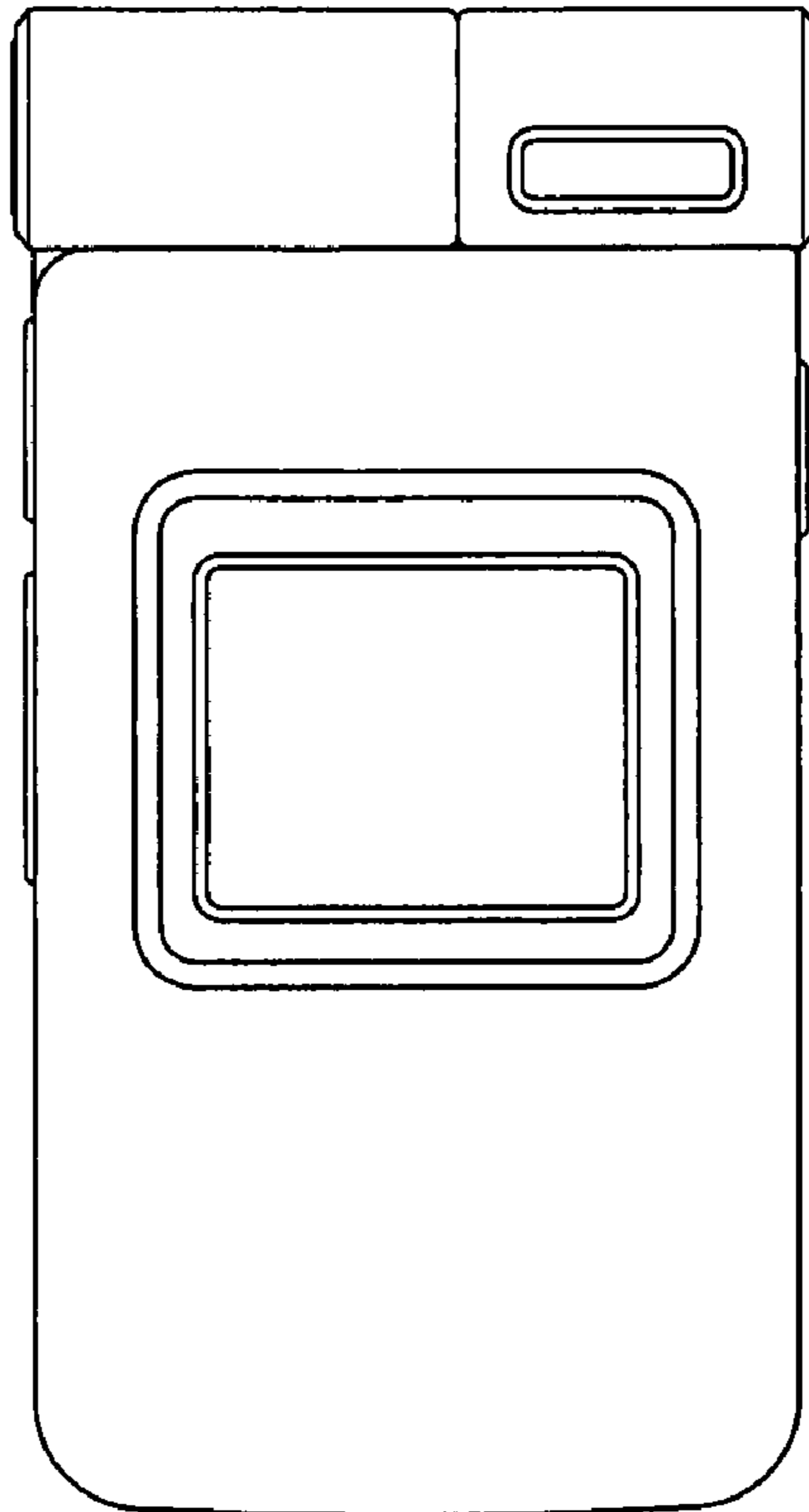
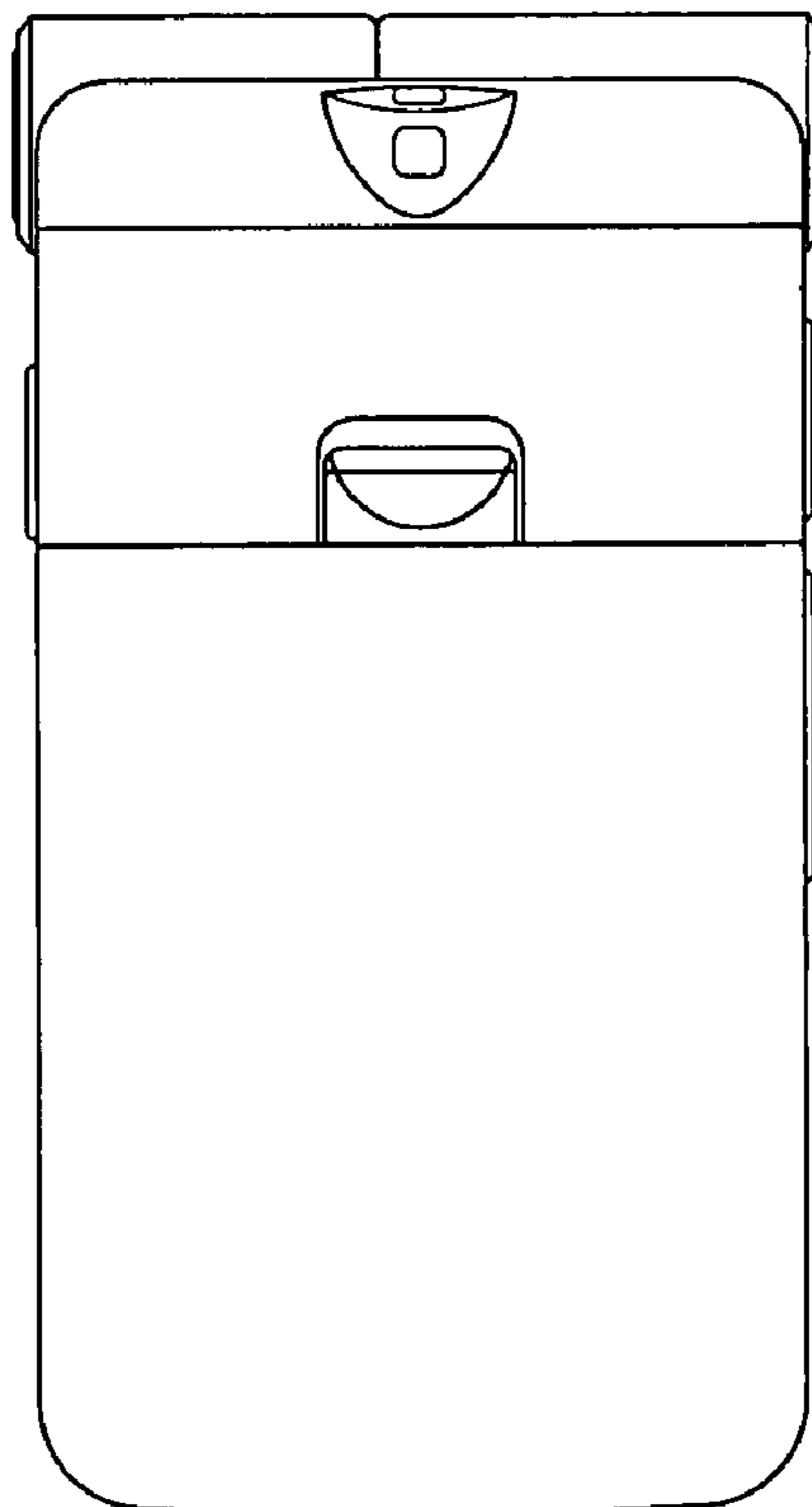

FIG. 3



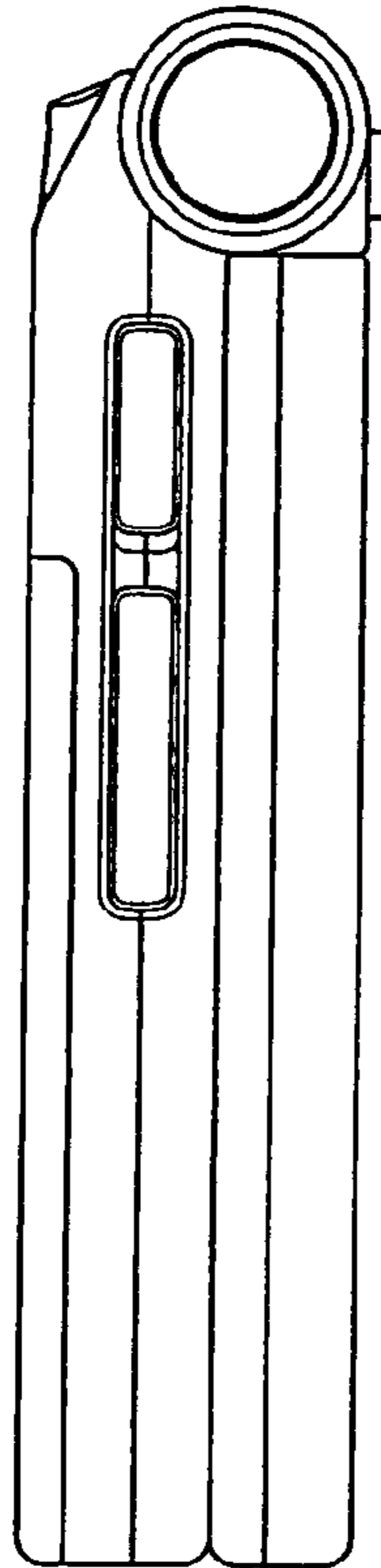

FIG. 4



FIG. 5

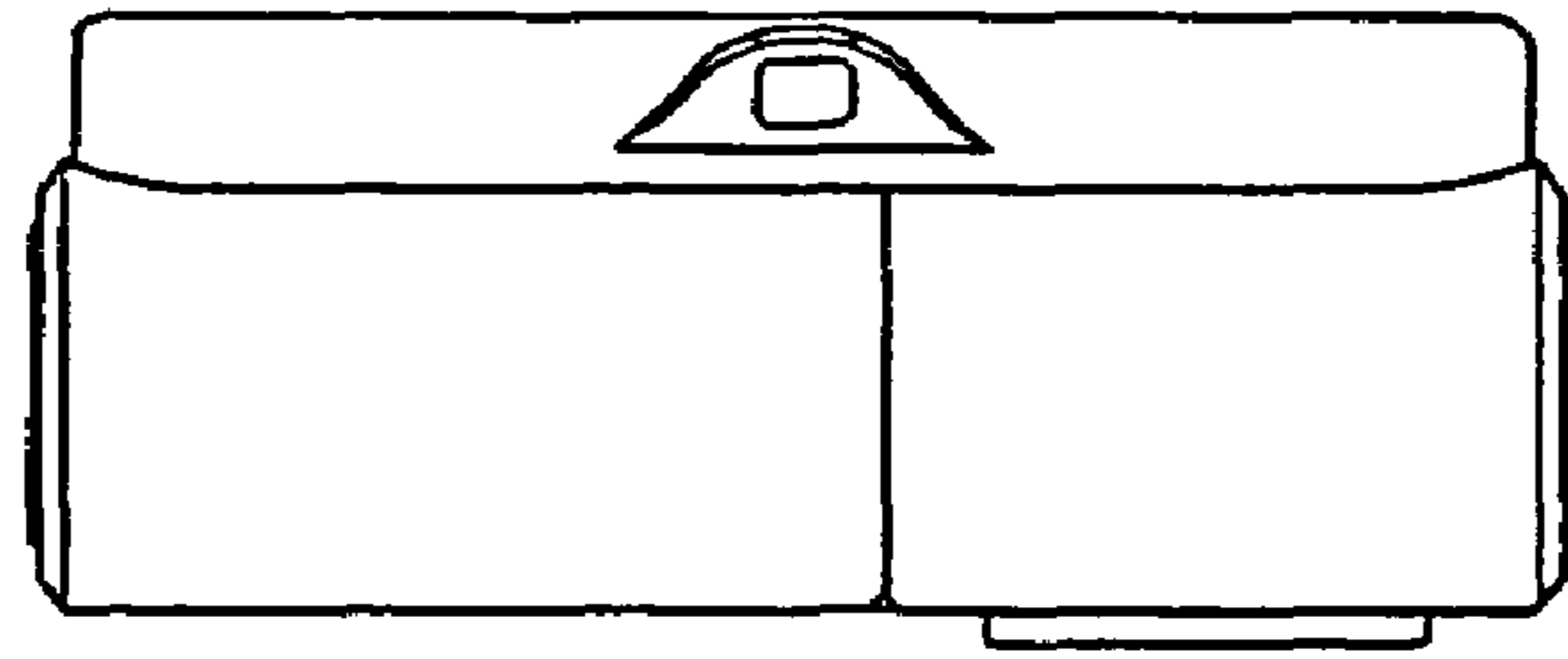

FIG. 6

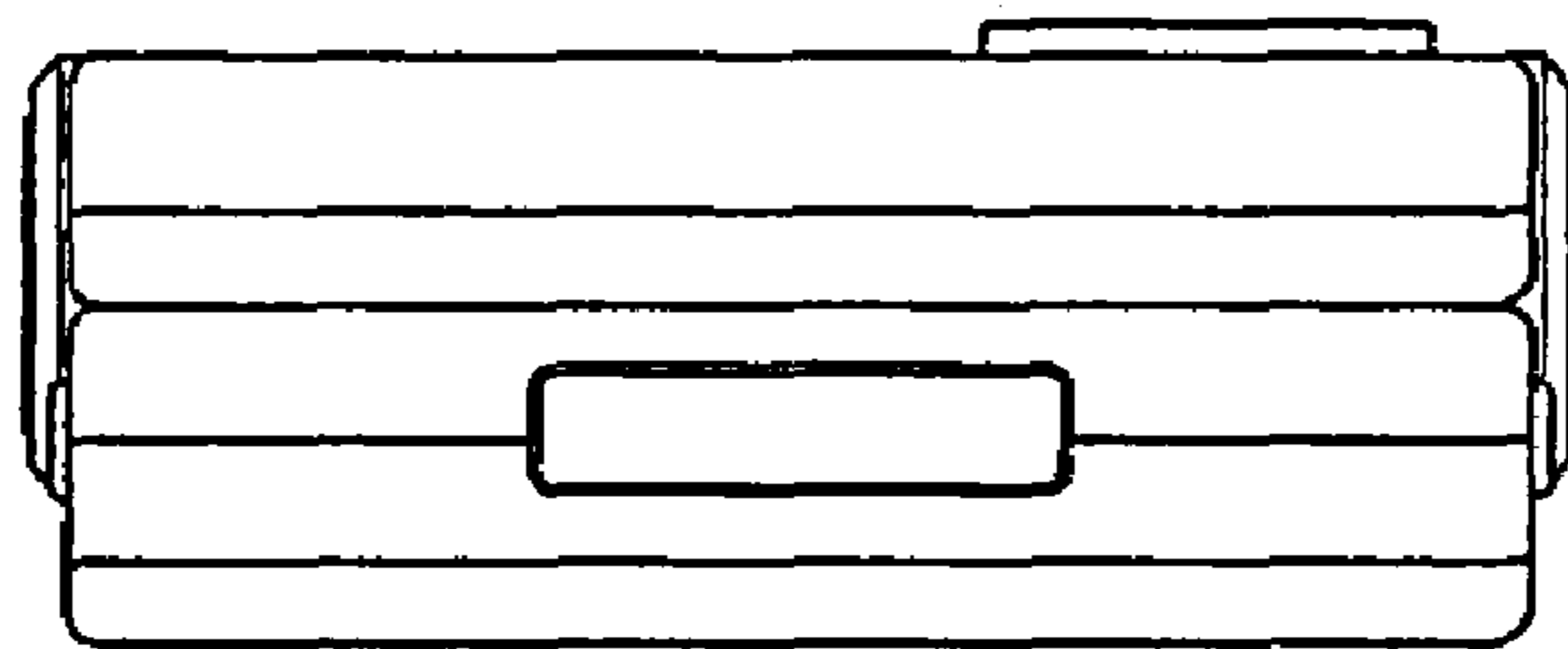

FIG. 7

FIG. 8

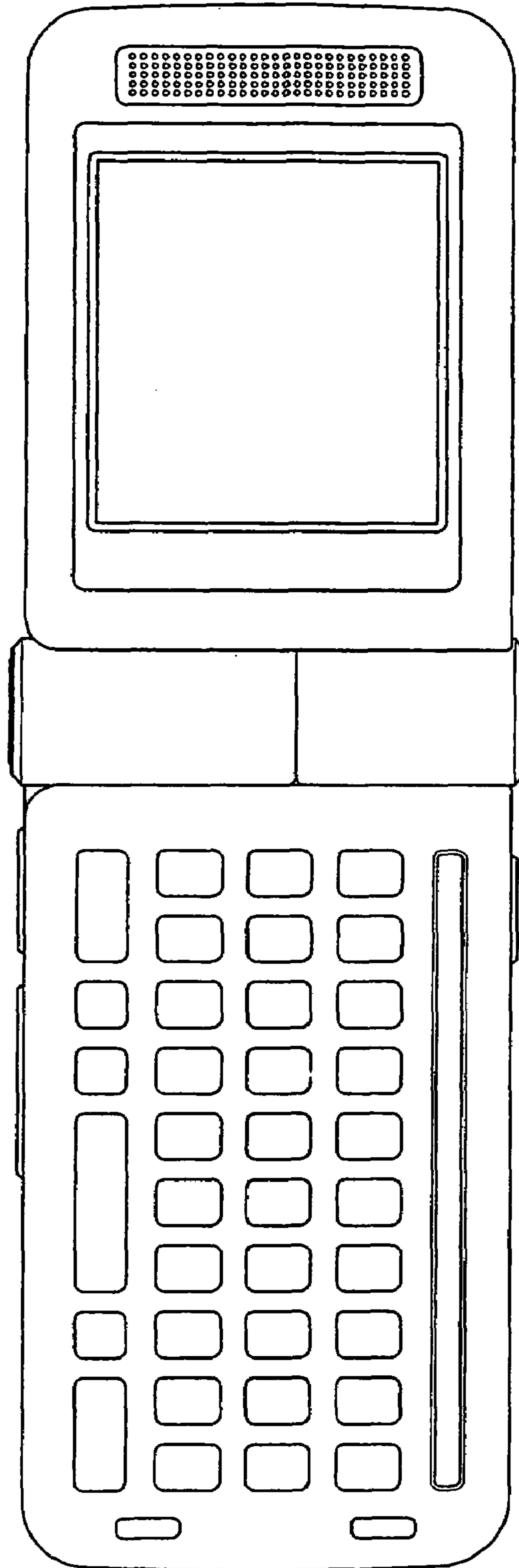

FIG. 9

