

US00D545262S

(12) **United States Design Patent**
Southey

(10) **Patent No.: US D545,262 S**

(45) **Date of Patent: ** Jun. 26, 2007**

(54) **WHEEL**

(76) Inventor: **Bruce Southey**, 8 Farnham Trading Estate, Water Lane, Farnham (GB) GU9 9NQ

(**) Term: **14 Years**

(21) Appl. No.: **29/270,438**

(22) Filed: **Dec. 21, 2006**

(51) **LOC (8) Cl.** **12-16**

(52) **U.S. Cl.** **D12/211**

(58) **Field of Classification Search** D12/204-213;
301/37.101, 64.101, 65

See application file for complete search history.

(56) **References Cited**

U.S. PATENT DOCUMENTS

D480,036 S *	9/2003	Laengerer	D12/211
D482,307 S *	11/2003	Lee	D12/211
D486,111 S *	2/2004	Weidhase	D12/211
D501,817 S *	2/2005	Pfeiffer	D12/211
D514,050 S *	1/2006	Scheu	D12/211

D516,488 S *	3/2006	Truebsbach	D12/209
D518,430 S *	4/2006	Scheu	D12/211
D526,949 S *	8/2006	Viandante	D12/211
D530,259 S *	10/2006	Sands	D12/211

* cited by examiner

Primary Examiner—Stacia Cadmus

(74) *Attorney, Agent, or Firm*—Welsh & Katz, Ltd.

(57) **CLAIM**

The ornamental design for a wheel, as shown and described.

DESCRIPTION

FIG. 1 is a perspective view of the wheel of the subject invention.

FIG. 2 is a right side view of the wheel of FIG. 1.

FIG. 3 is a left side view of the wheel of FIG. 1.

FIG. 4 is a top side view of the wheel of FIG. 1, the opposite side being a mirror image thereof.

FIG. 5 is a bottom view of the wheel of FIG. 1; and,

FIG. 6 is a front view of the wheel of FIG. 1.

1 Claim, 4 Drawing Sheets

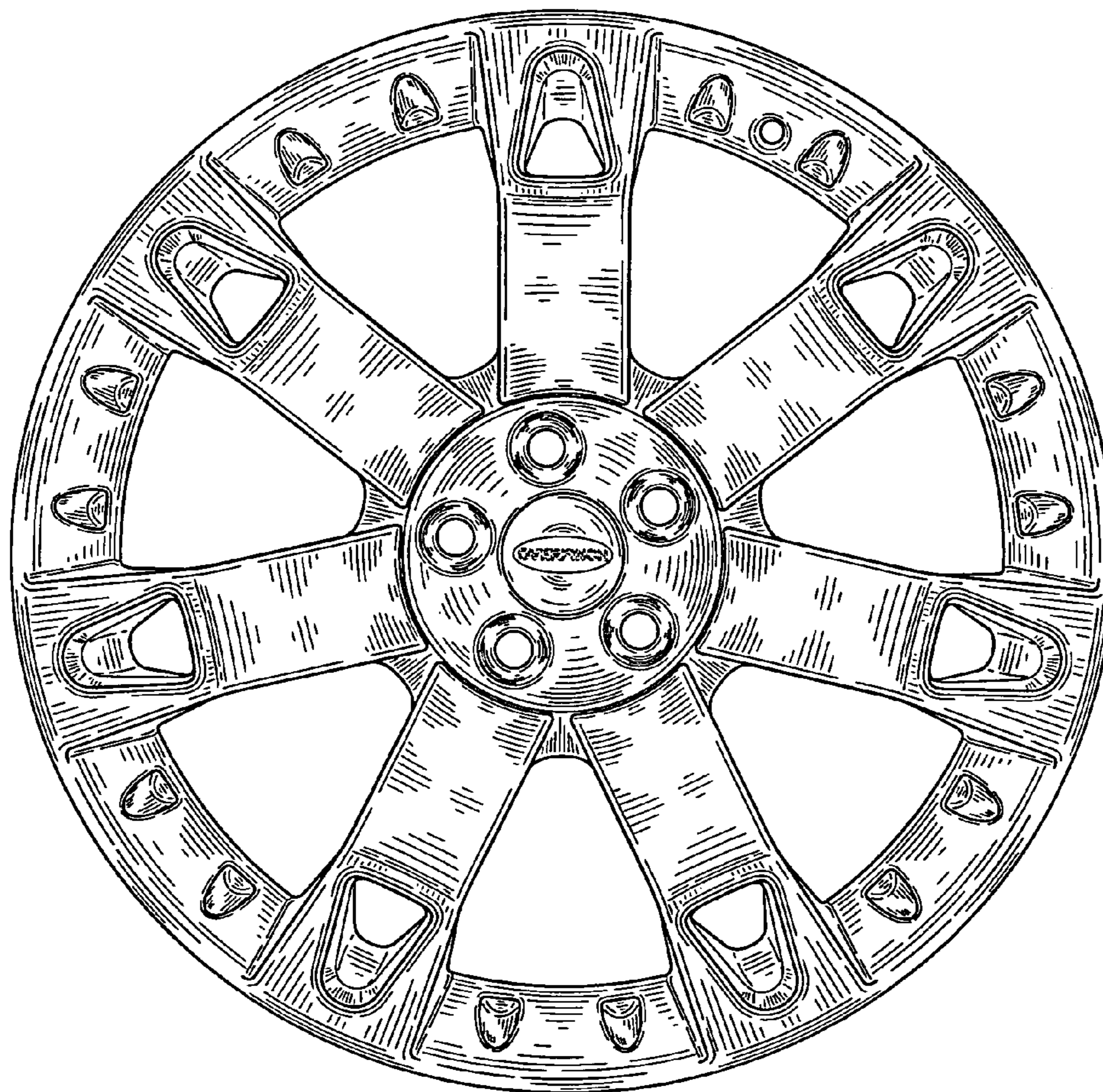

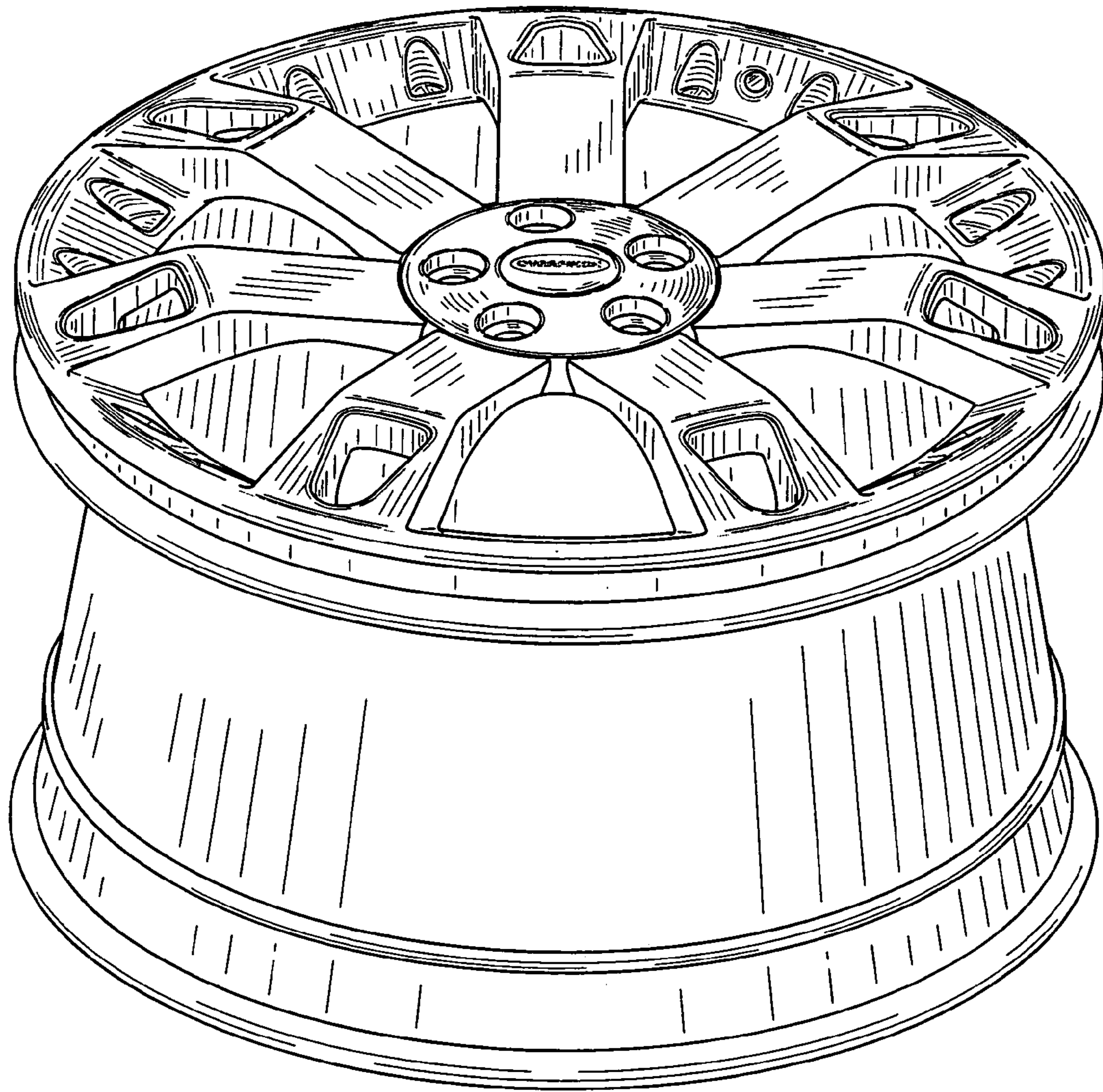

FIG. 1

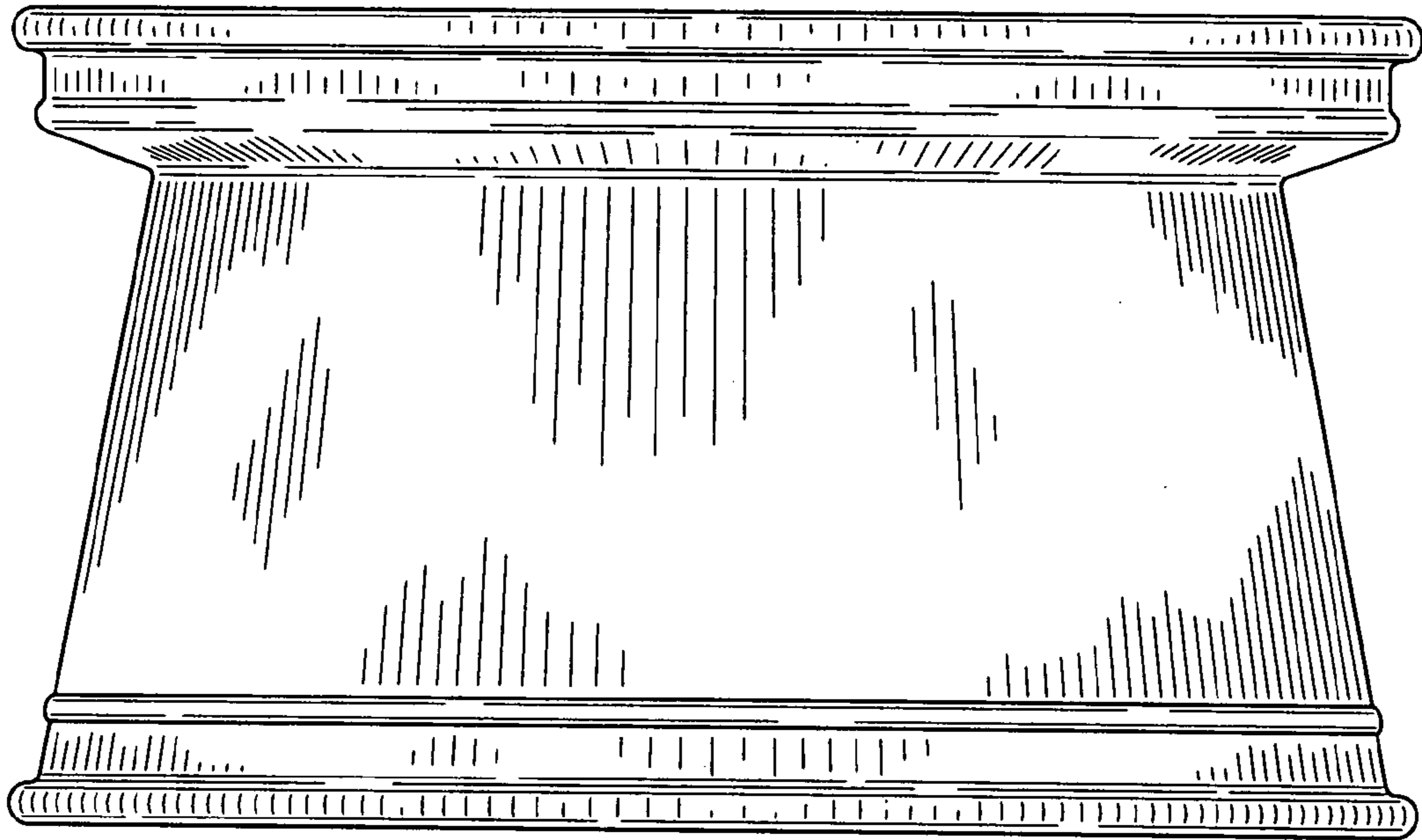

FIG. 2

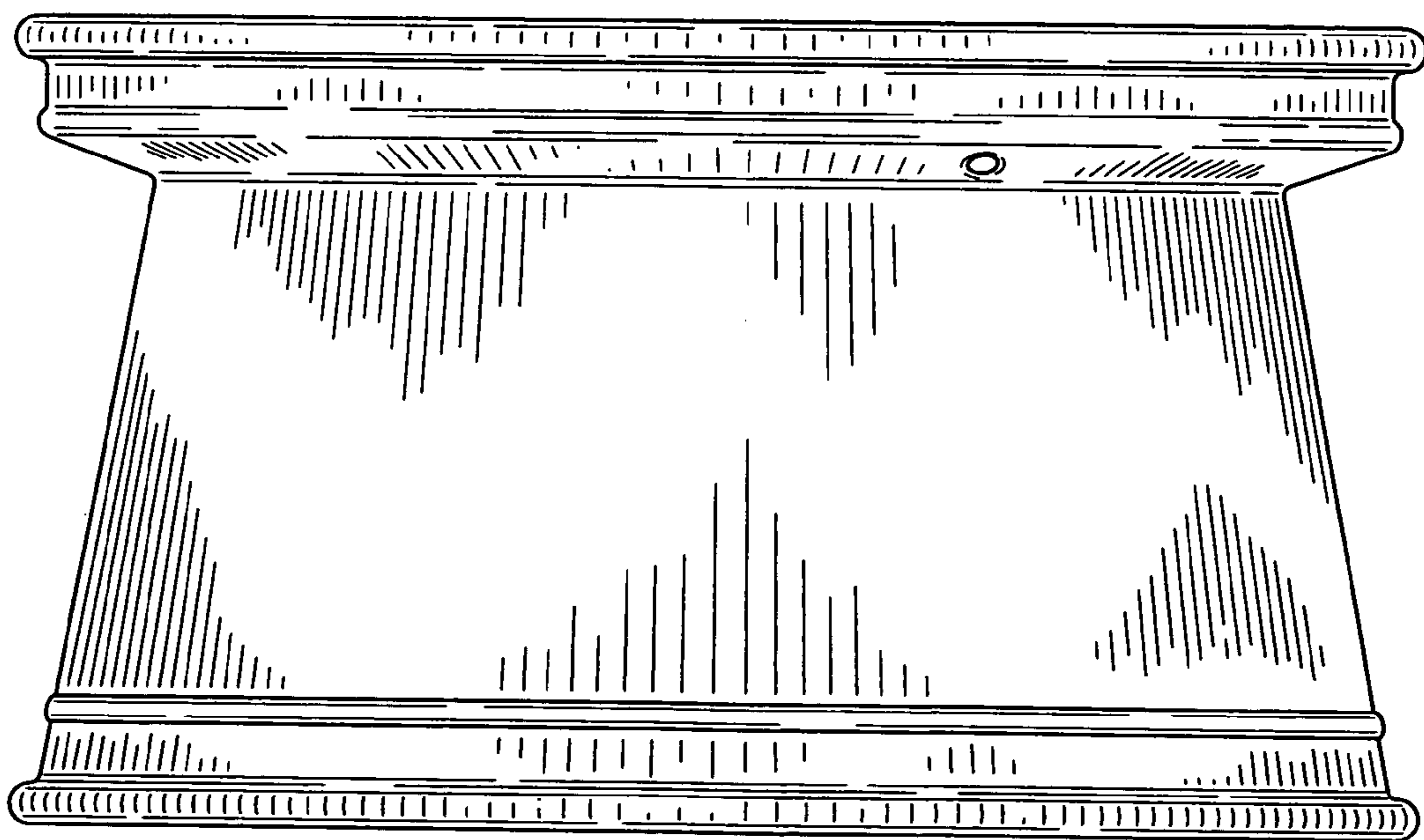

FIG. 3

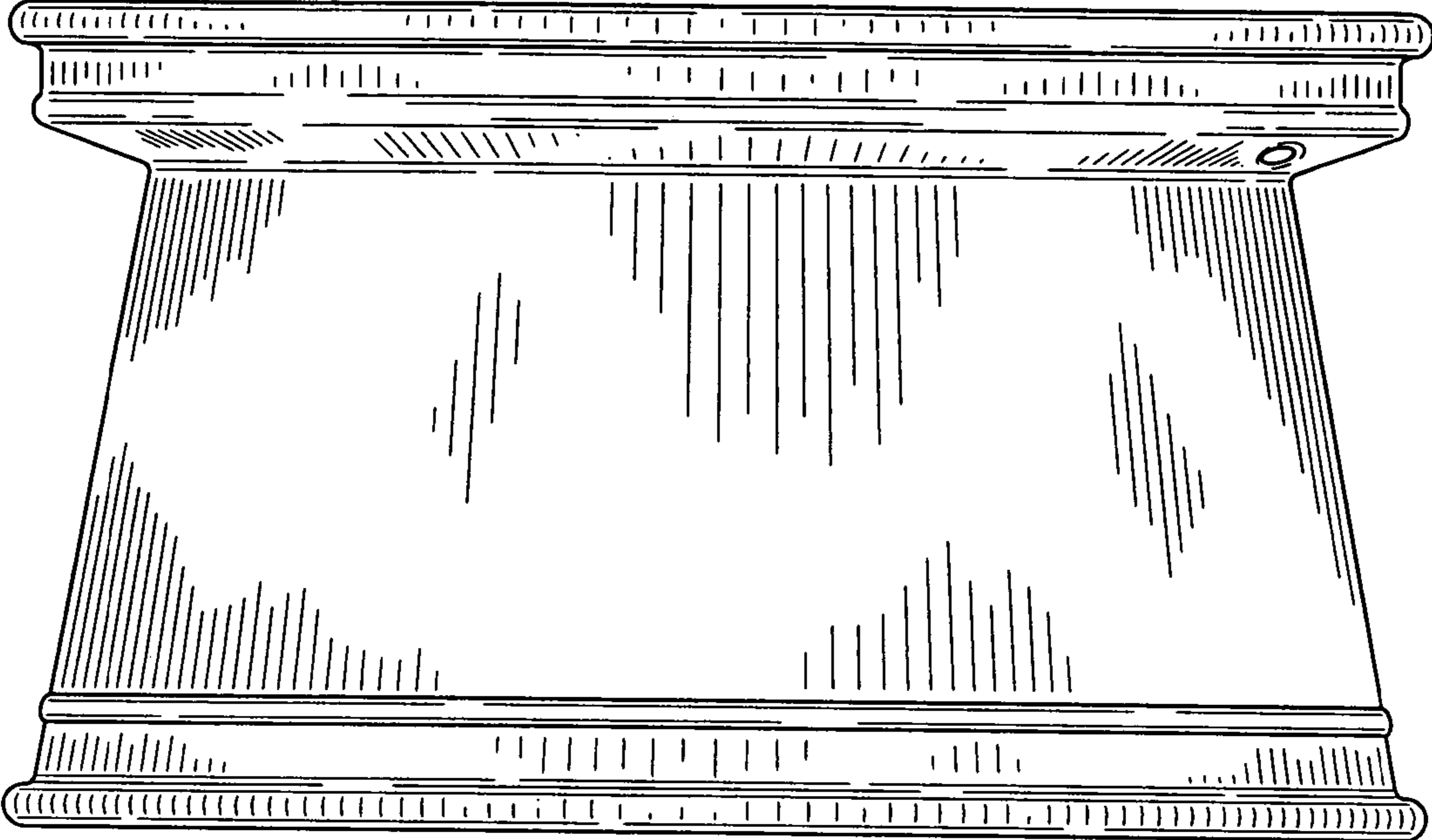

FIG. 4

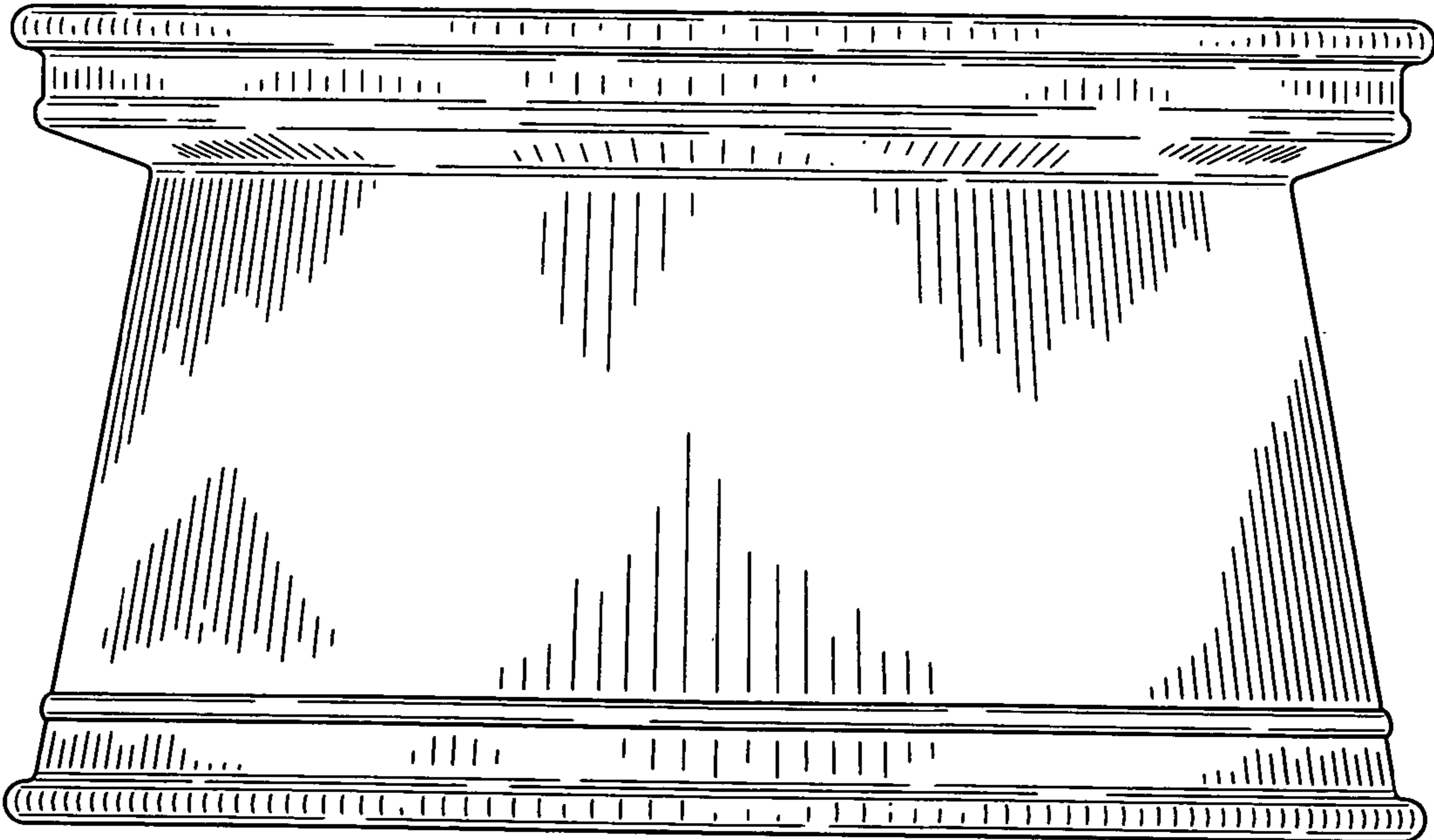

FIG. 5

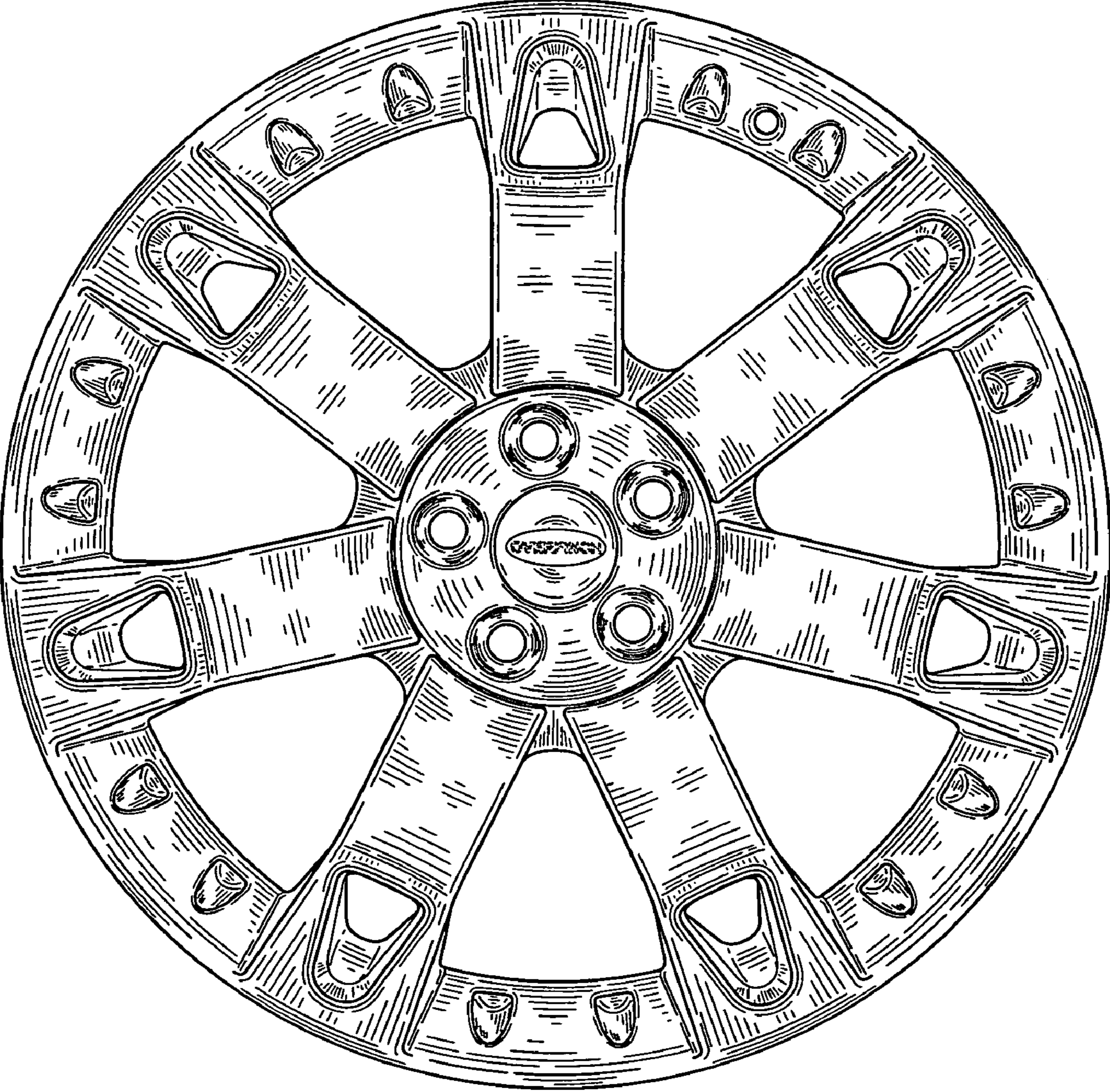

FIG. 6