

US00D545064S

(12) **United States Design Patent**  
**Knight et al.**

(10) **Patent No.:** **US D545,064 S**

(45) **Date of Patent:** **\*\* Jun. 26, 2007**

(54) **HAIRBRUSH**

(75) Inventors: **Jonathan Knight**, London (GB);  
**Zoltan Radivojevic**, London (GB)

(73) Assignee: **Denroy Group Limited**, Bangor (GB)

(\*\*) Term: **14 Years**

(21) Appl. No.: **29/200,962**

(22) Filed: **Mar. 9, 2004**

(30) **Foreign Application Priority Data**

Sep. 9, 2003 (GB) ..... 3014357

(51) **LOC (8) Cl.** ..... **04-02**

(52) **U.S. Cl.** ..... **D4/121; D4/136**

(58) **Field of Classification Search** ..... D4/121,  
D4/122, 132-134, 136, 138; D25/10, 23,  
D25/28; 15/159.1, 160, 169, 185-188, 203;  
132/120, 121, 141-143, 313; 601/134-137  
See application file for complete search history.

(56) **References Cited**

**U.S. PATENT DOCUMENTS**

4,023,230 A \* 5/1977 Friedman et al. .... 15/185  
4,116,205 A \* 9/1978 Owen et al. .... 132/313  
4,987,633 A \* 1/1991 Heneveld ..... 15/185

D336,784 S \* 6/1993 Yen ..... D4/122  
6,283,930 B1 \* 9/2001 Purvis et al. .... 601/137  
2005/0194016 A1 \* 9/2005 Yeh ..... 132/121

\* cited by examiner

*Primary Examiner*—Alan P. Douglas

*Assistant Examiner*—Lavone D. Tabor

(74) *Attorney, Agent, or Firm*—Ronald E. Greigg

(57) **CLAIM**

The ornamental design for a hairbrush, as shown and described.

**DESCRIPTION**

FIG. 1 is a first end view of the hairbrush in a closed configuration;

FIG. 2 is a second end view of the hairbrush in a closed configuration;

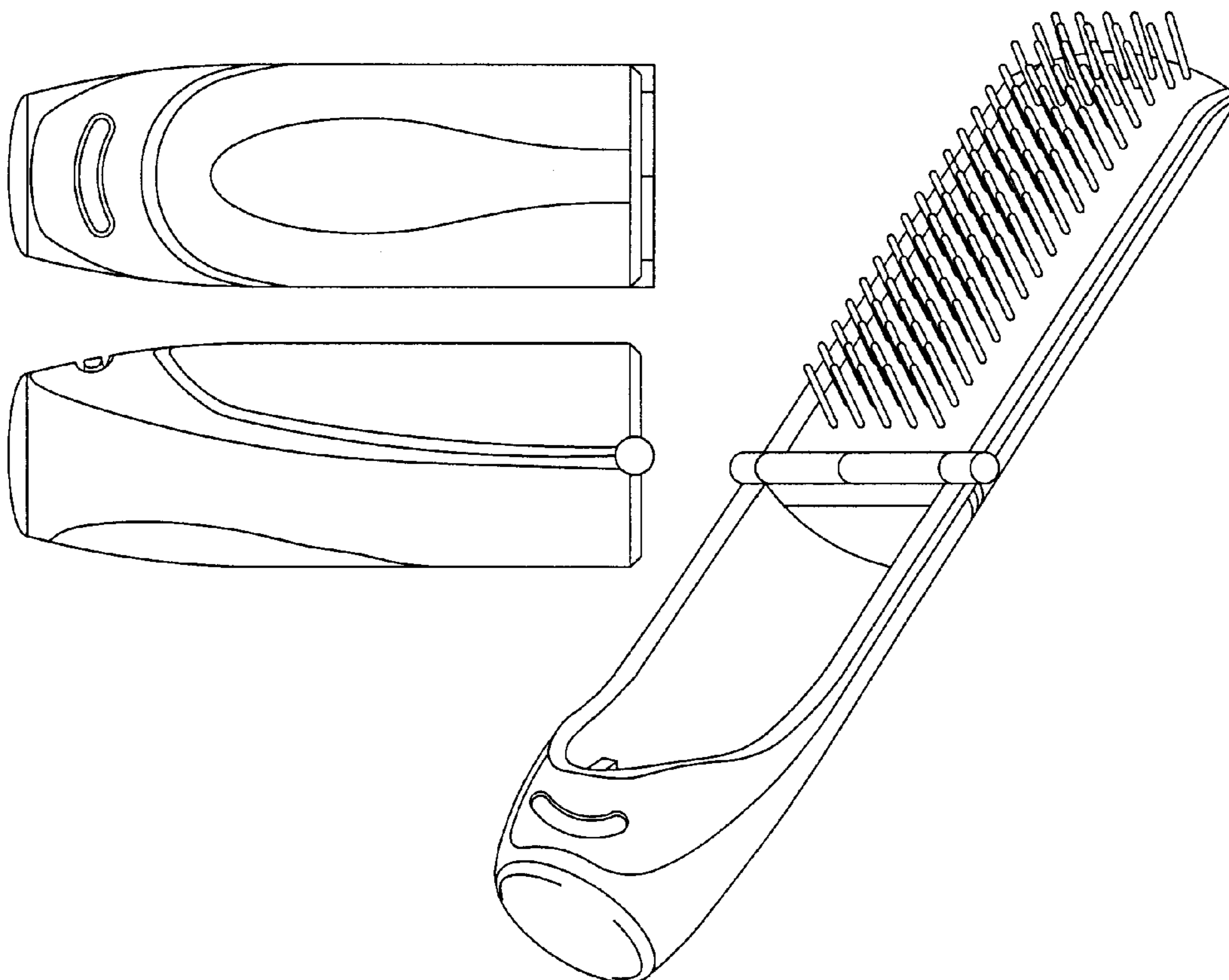
FIG. 3 is a top plan view of the closed hairbrush;

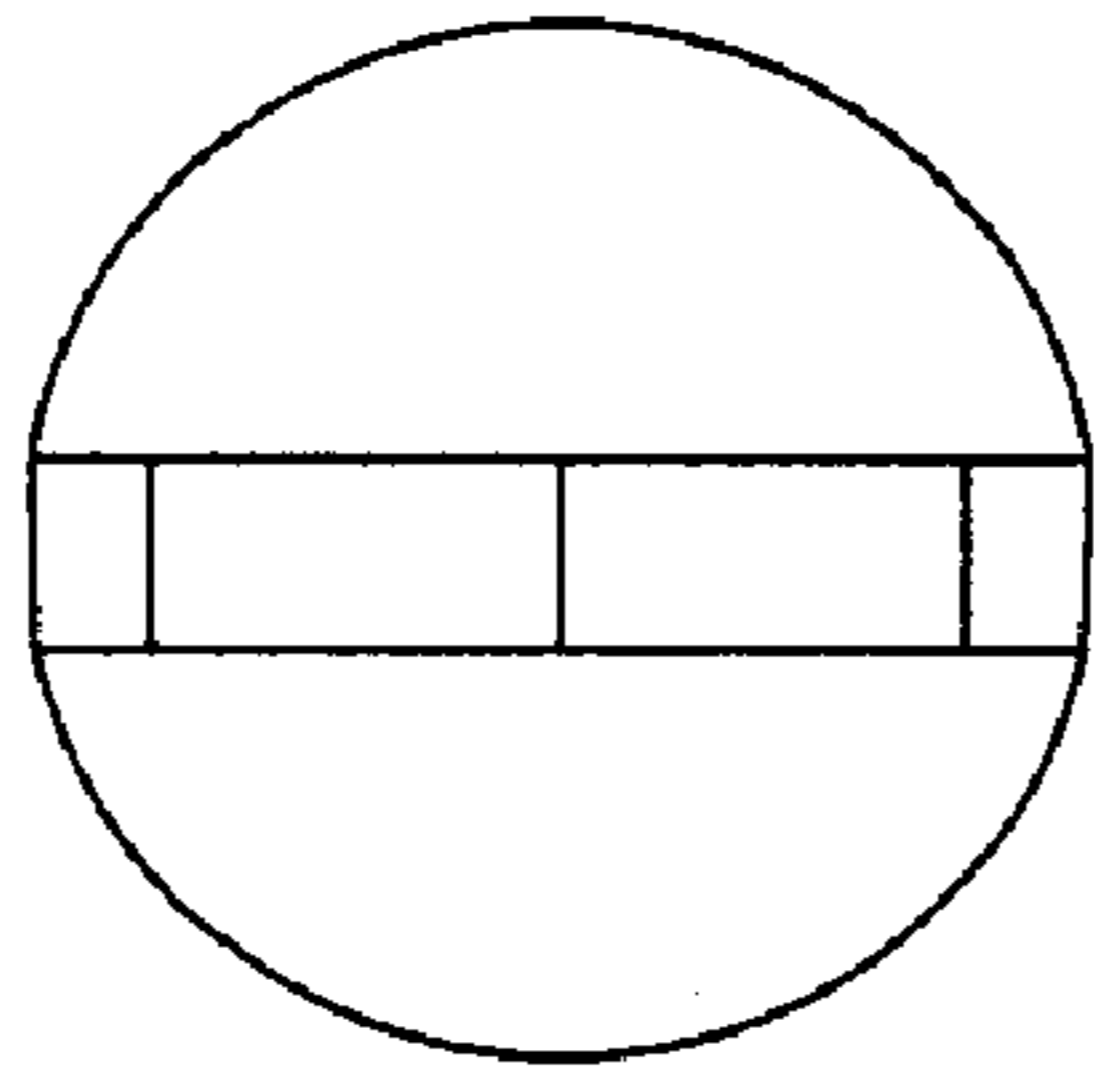
FIG. 4 is a side view of the closed hairbrush (the other side view being a mirror image);

FIG. 5 is an bottom plan view of the closed hairbrush; and,

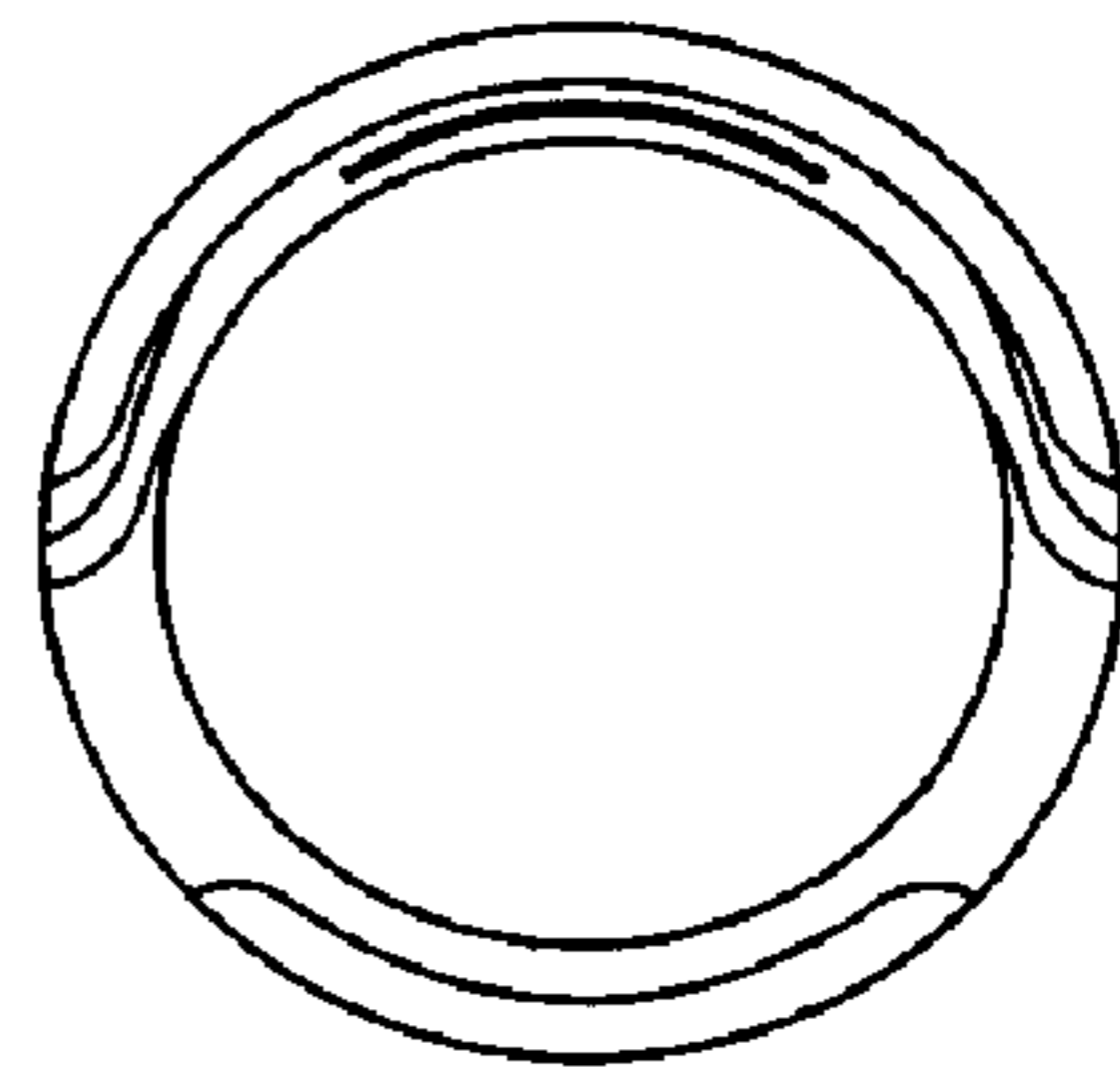
FIG. 6 is a perspective view of the hairbrush in an opened position.

**1 Claim, 2 Drawing Sheets**



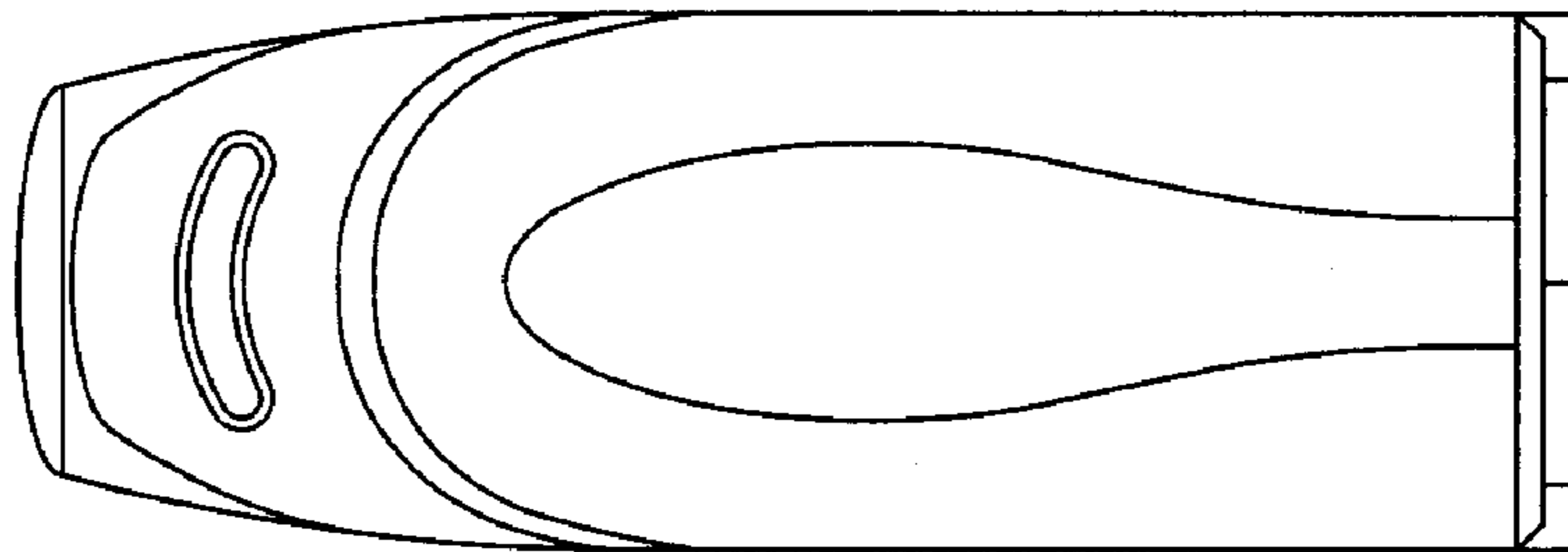


**FIG. 1**

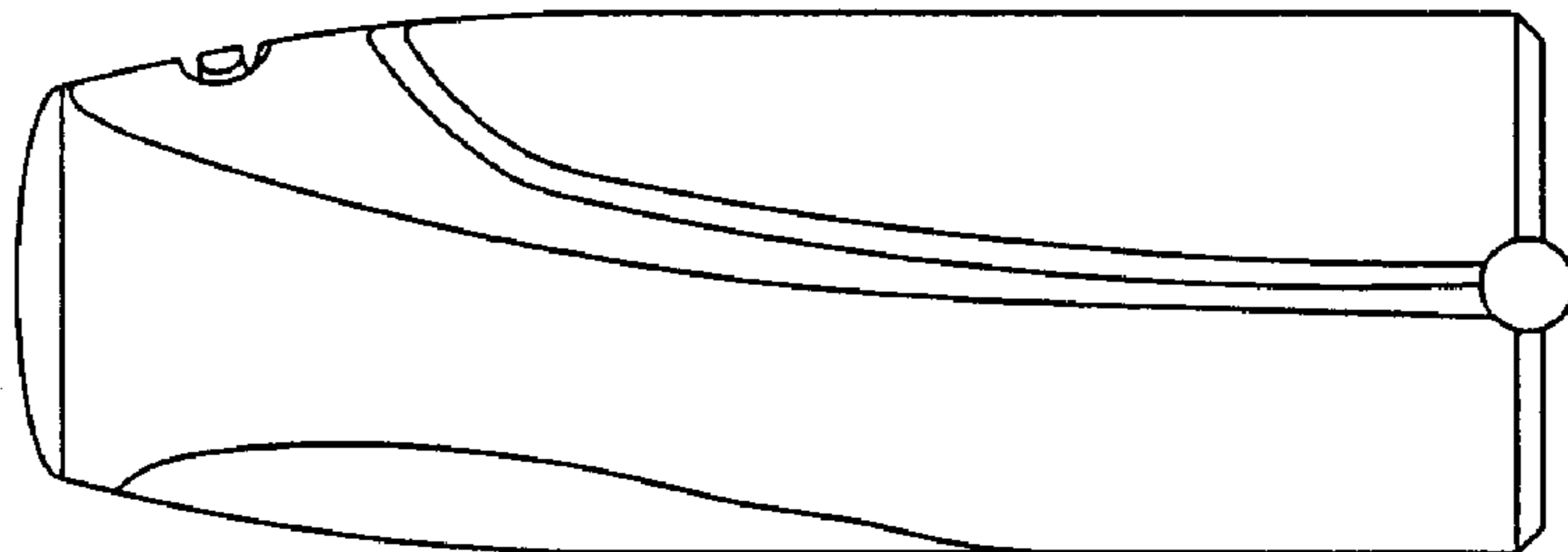


**FIG. 2**

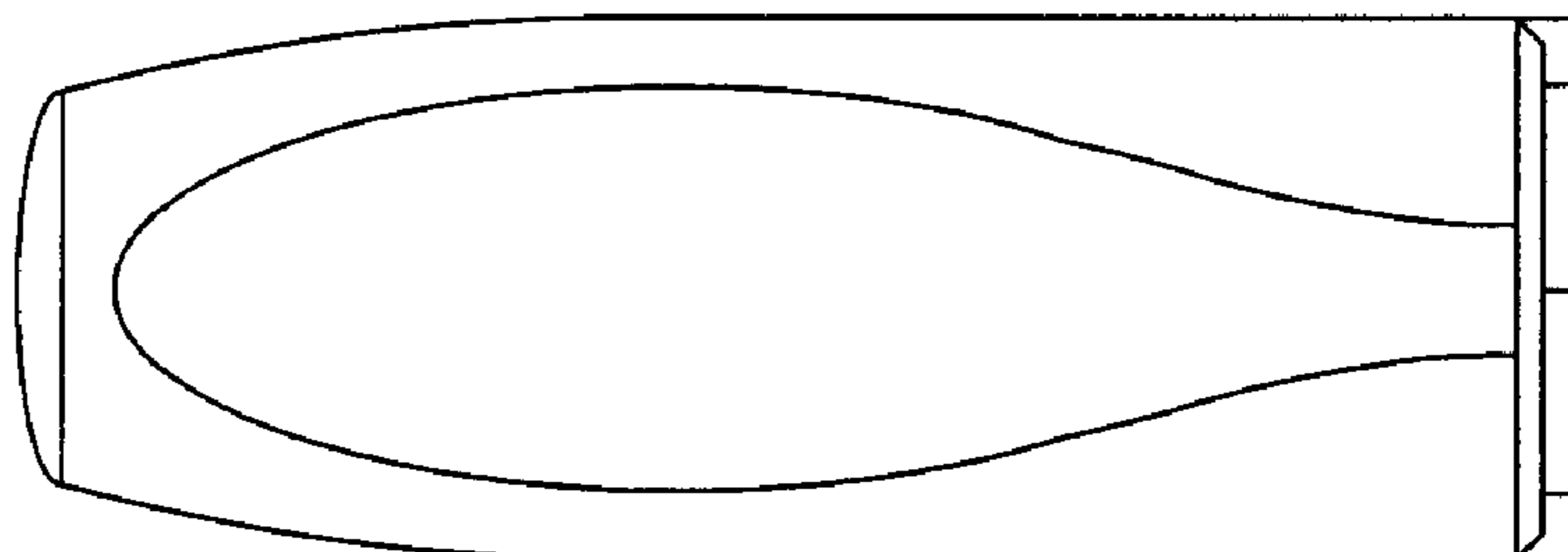
**FIG. 3**

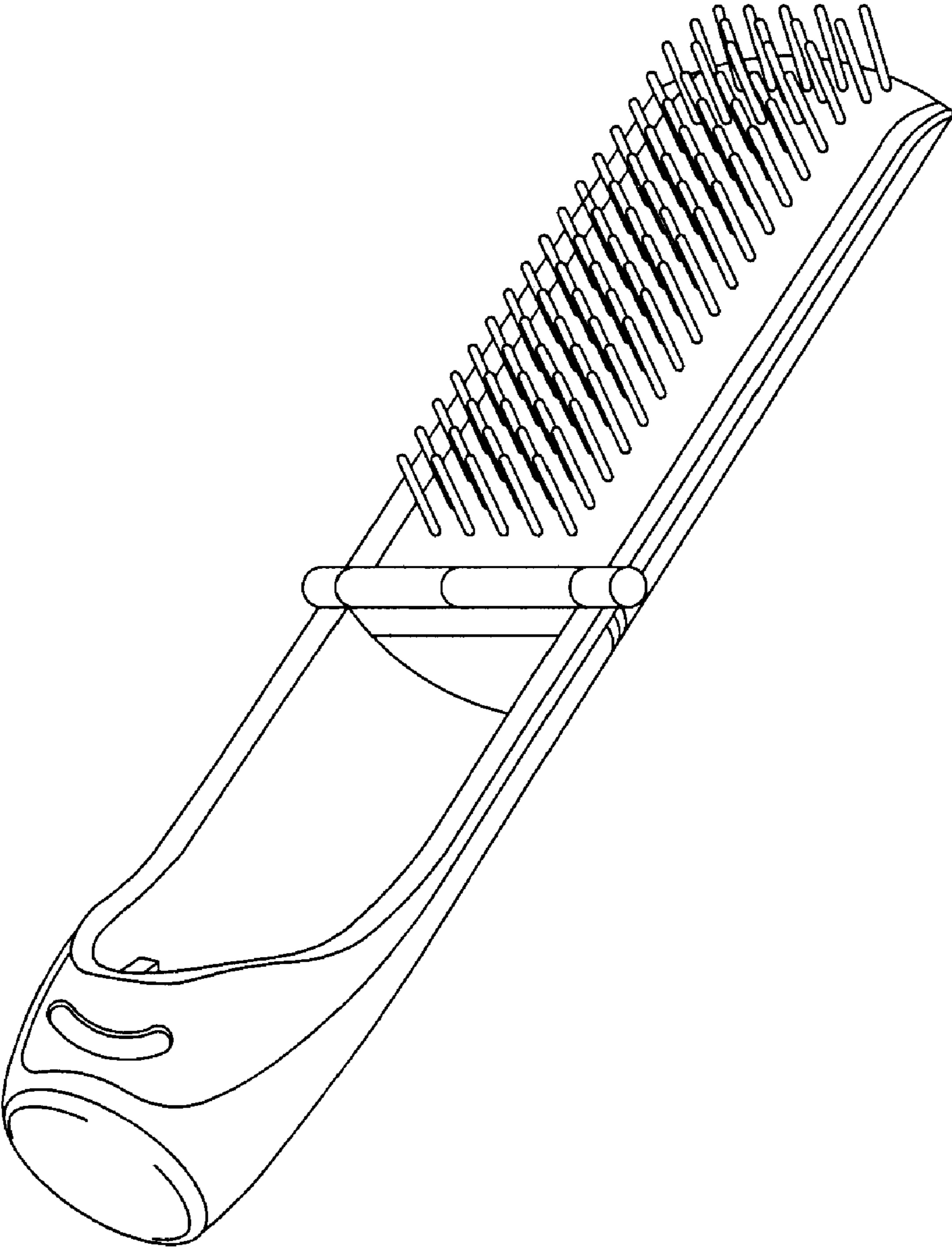


**FIG. 4**



**FIG. 5**





**FIG. 6**