

US00D545037S

(12) **United States Design Patent**  
**Shaffer**

(10) **Patent No.:** **US D545,037 S**

(45) **Date of Patent:** **\*\* Jun. 26, 2007**

(54) **PORTION OF A SHOE UPPER**

(75) Inventor: **Benjamin Andrew Shaffer**, Beaverton,  
OR (US)

(73) Assignee: **Nike, Inc.**, Beaverton, OR (US)

(\*\*) Term: **14 Years**

(21) Appl. No.: **29/276,871**

(22) Filed: **Feb. 8, 2007**

(51) **LOC (8) Cl.** ..... **02-99**

(52) **U.S. Cl.** ..... **D2/969; D2/971**

(58) **Field of Classification Search** ..... D2/902,  
D2/906-908, 925, 943, 944, 969, 971-974;  
36/45, 50.1, 77 M, 77 R, 83, 88, 113, 114,  
36/126-131

See application file for complete search history.

(56) **References Cited**

**U.S. PATENT DOCUMENTS**

D82,990 S	1/1931	Hubbell	
D147,003 S	7/1947	Chaplain	
D170,782 S	11/1953	Wegner	
2,788,591 A	4/1957	Gibson	
4,200,997 A	5/1980	Scheinhaus et al.	
D292,944 S	12/1987	Kelley	
4,920,664 A	5/1990	McGregor et al.	
5,205,054 A	4/1993	York, Jr.	
5,228,216 A	7/1993	Sargeant	
D342,369 S	12/1993	Lamson	
D348,977 S	7/1994	Koh	
D353,483 S	12/1994	Bailey	
D513,361 S	1/2006	Teriatnikov	
D513,836 S *	1/2006	Magro et al.	D2/896
D514,295 S *	2/2006	Belley et al.	D2/969
D514,788 S	2/2006	Schoenborn et al.	
D517,294 S *	3/2006	Belley et al.	D2/969
D517,298 S	3/2006	James	
D517,784 S	3/2006	Wilkenfeld et al.	

D532,962 S *	12/2006	Teteriatnikov	D2/971
D538,022 S *	3/2007	Belley et al.	D2/969
D538,520 S *	3/2007	Belley et al.	D2/969
D539,020 S *	3/2007	Belley et al.	D2/969
D539,021 S *	3/2007	Belley et al.	D2/969
D539,022 S *	3/2007	Belley	D2/969

**OTHER PUBLICATIONS**

Nike Footwear Catalog Spring 2000 #2, published Jul. 1999, p. M64.

Nike Footwear Catalog Late Spring 2001, published Sep. 2000, p. M113.

Nike Footwear Catalog Late Spring 2004, published Sep. 2003, p. W46.

Nike Footwear Catalog Spring 2005, published Jun. 2004, p. W18.

Nike Footwear Catalog Late Spring 2006, published Sep. 2005, pp. W151 and W161.

\* cited by examiner

*Primary Examiner*—Dominic Simone

(74) *Attorney, Agent, or Firm*—Banner & Witcoff, Ltd.

(57) **CLAIM**

The ornamental design for a portion of a shoe upper, as shown and described.

**DESCRIPTION**

FIG. 1 is a front perspective view of a portion of a shoe upper showing my new design.

FIG. 2 is a lateral side view thereof.

FIG. 3 is a medial side view thereof.

FIG. 4 is a front view thereof.

FIG. 5 is a rear view thereof; and,

FIG. 6 is a top view thereof.

The uneven broken line showing of the remainder of the shoe is for illustrative purposes only and forms no part of the claimed design.

**1 Claim, 5 Drawing Sheets**

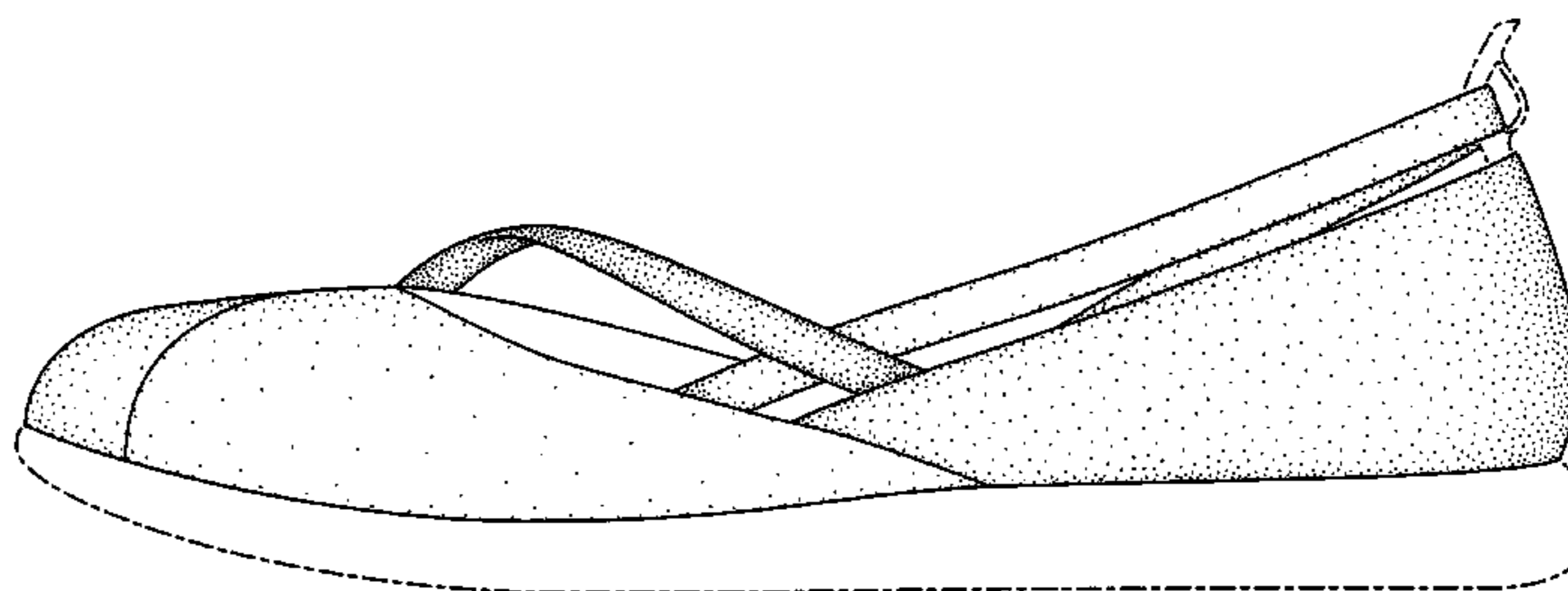
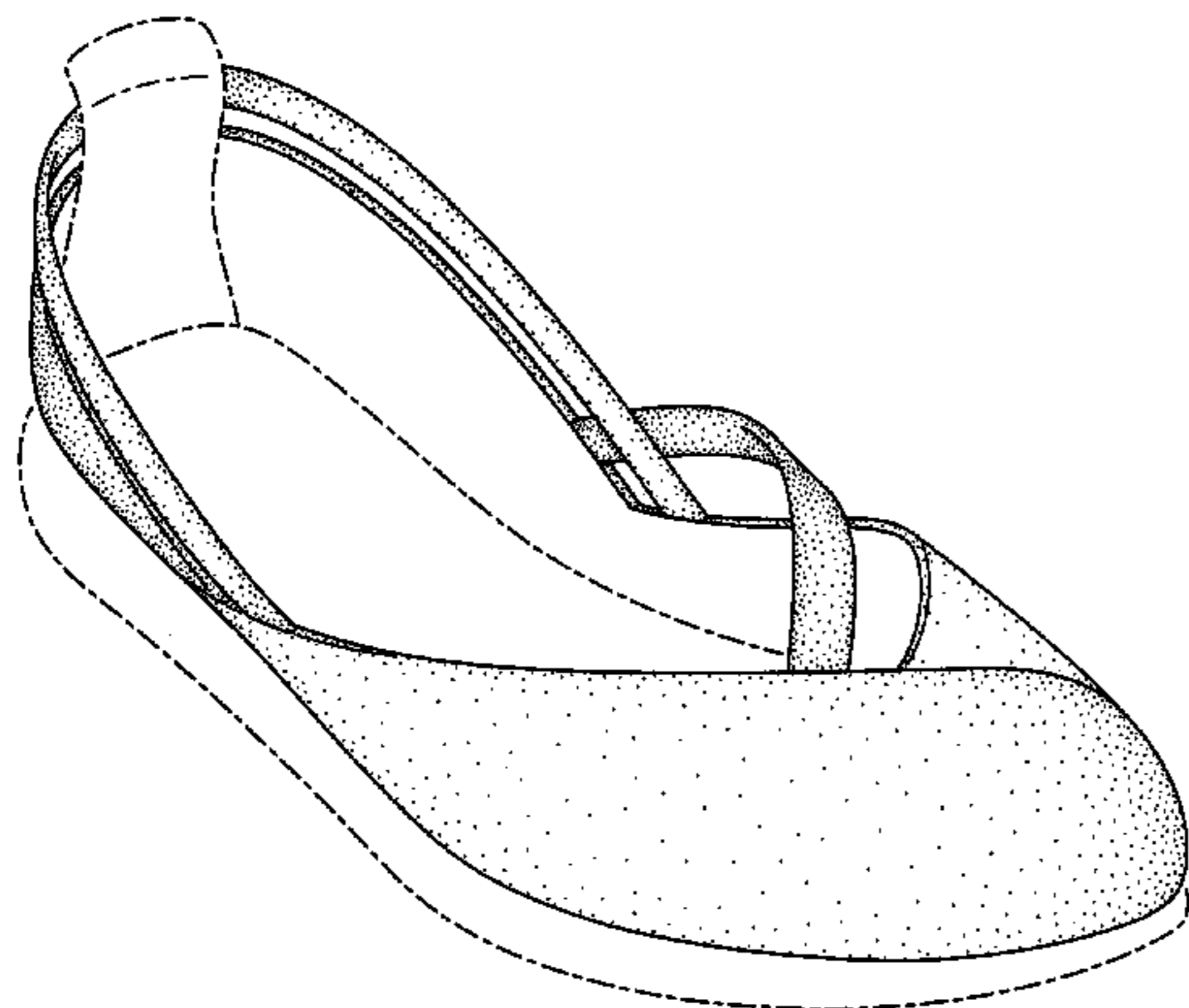

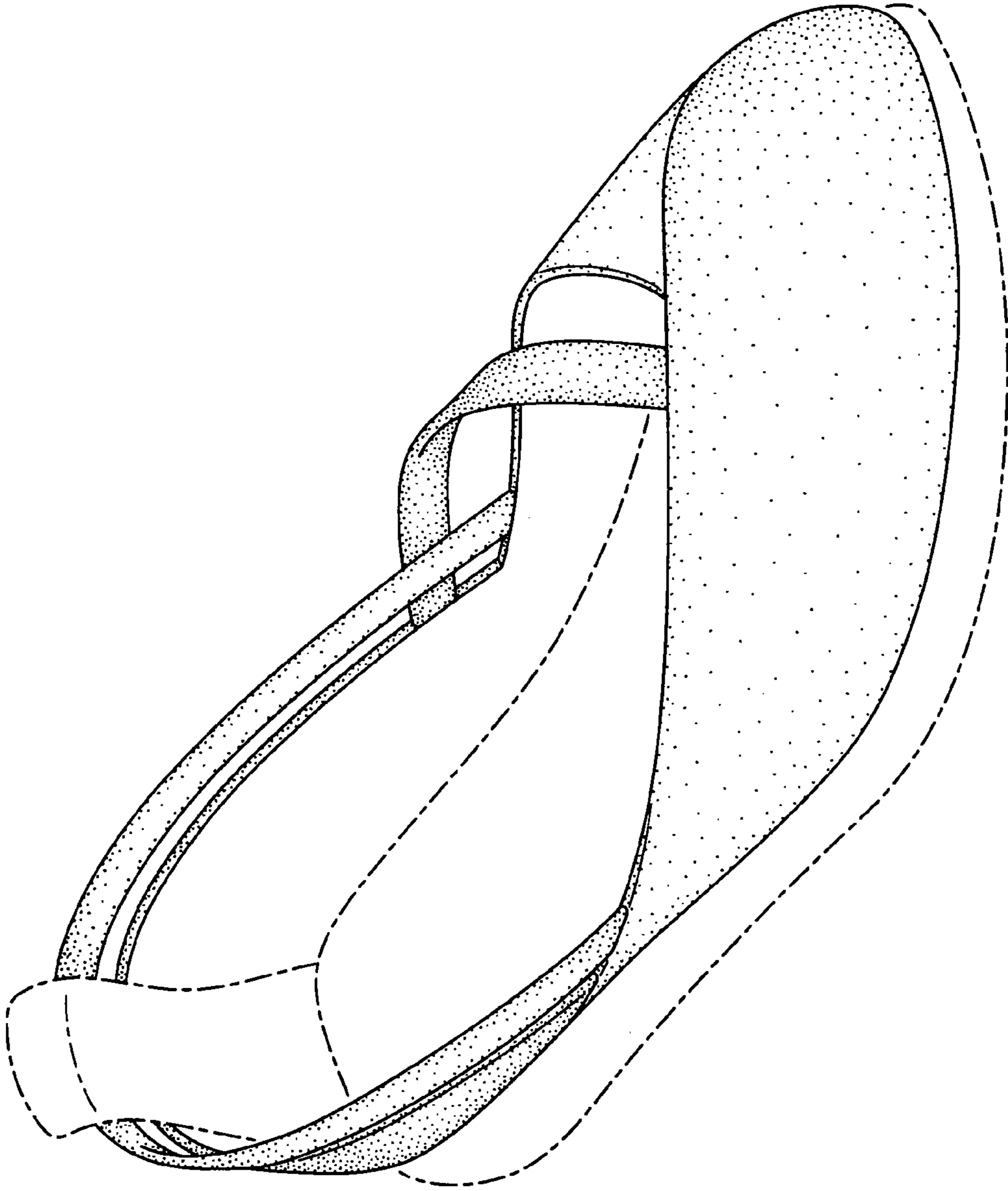

FIG. 1

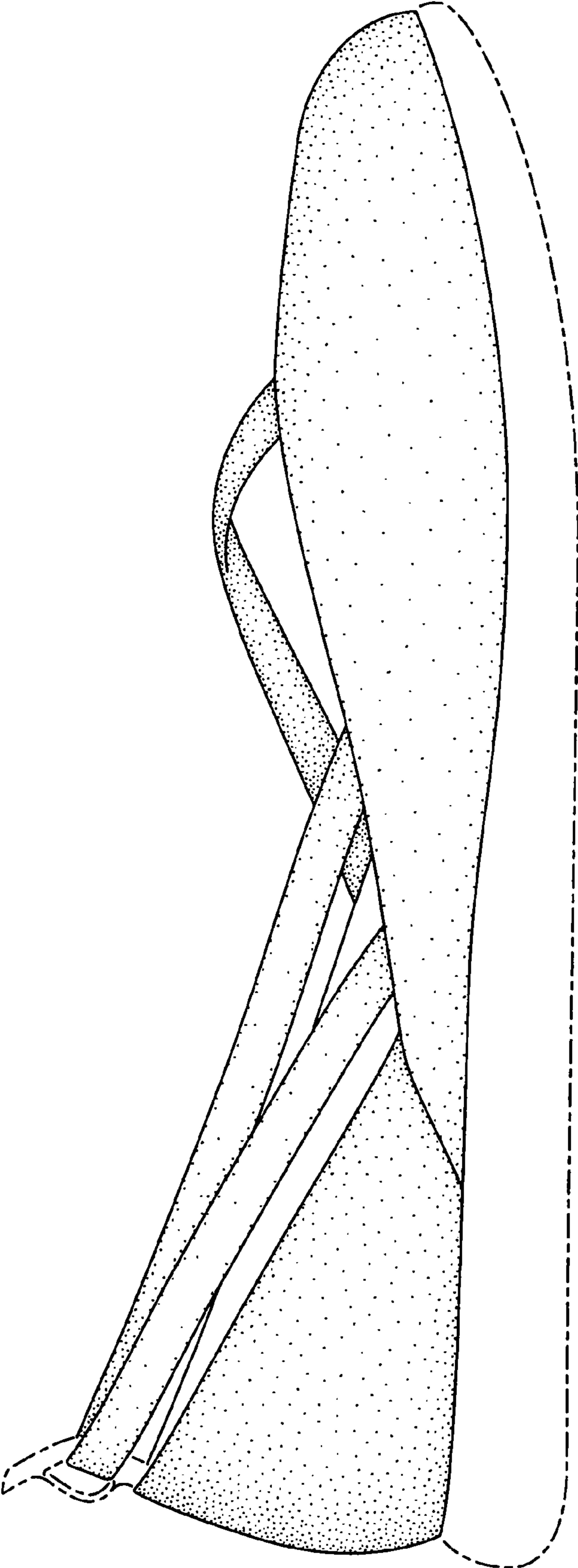

FIG. 2

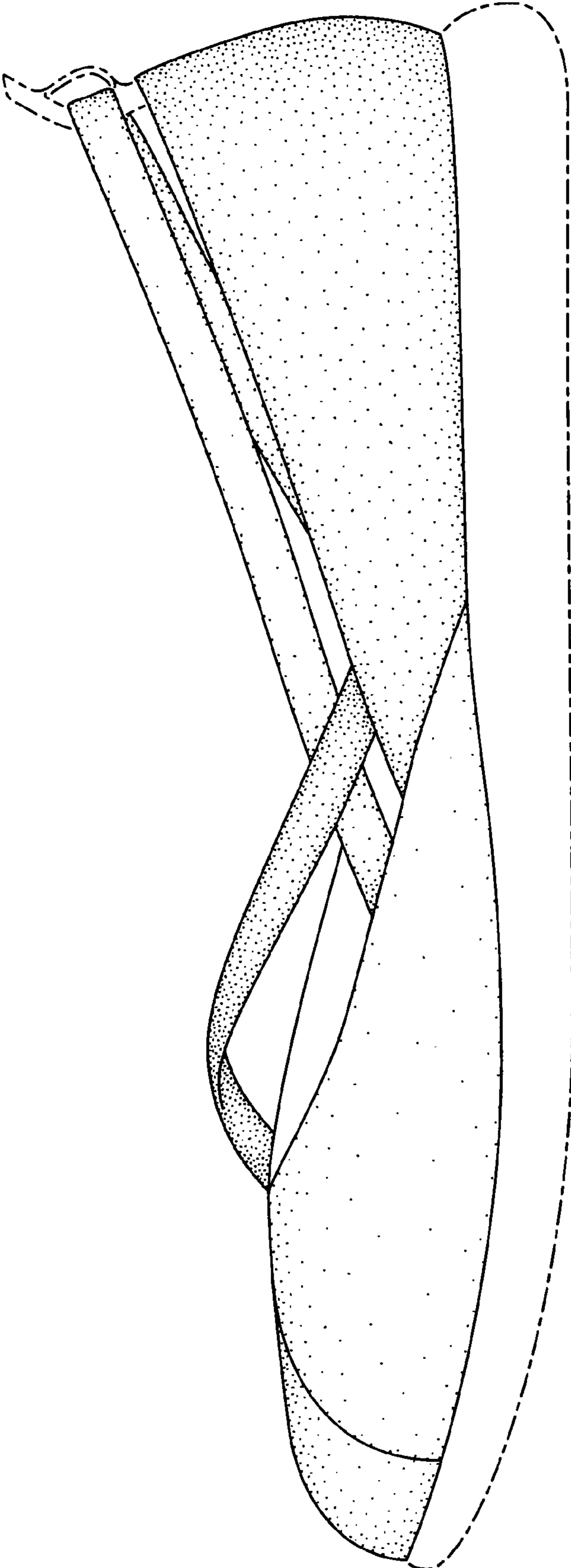

FIG. 3

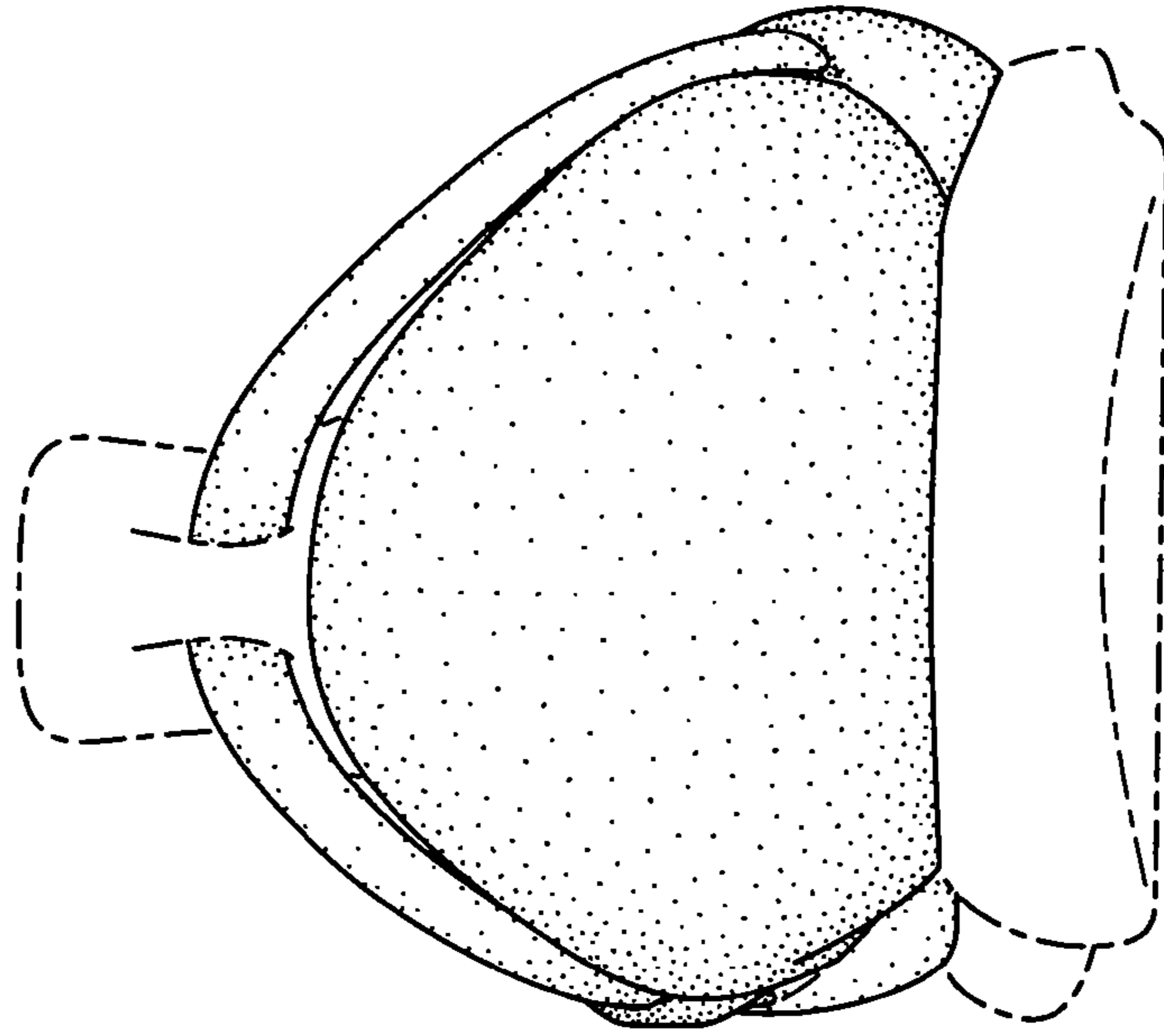

FIG. 5

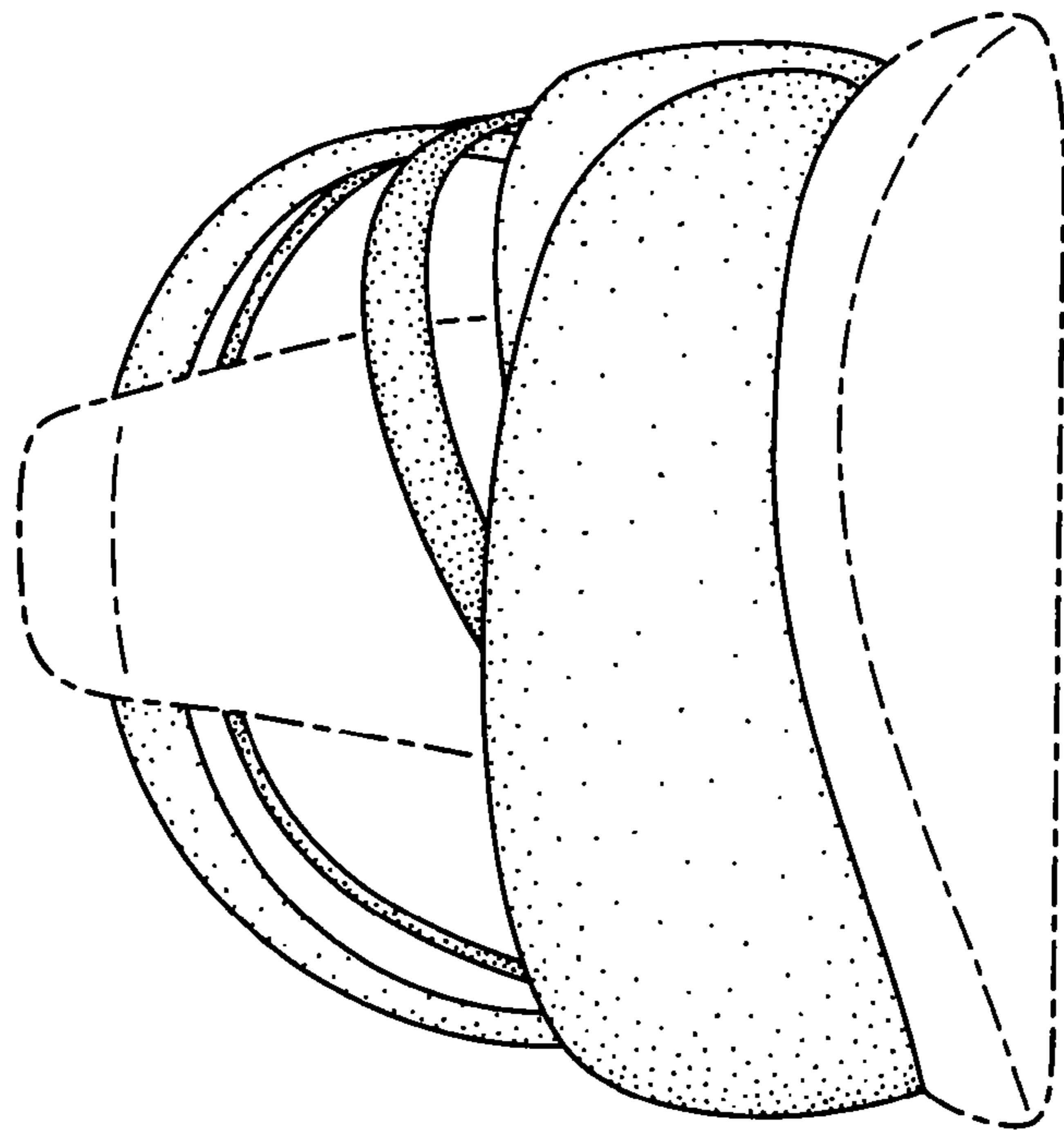

FIG. 4

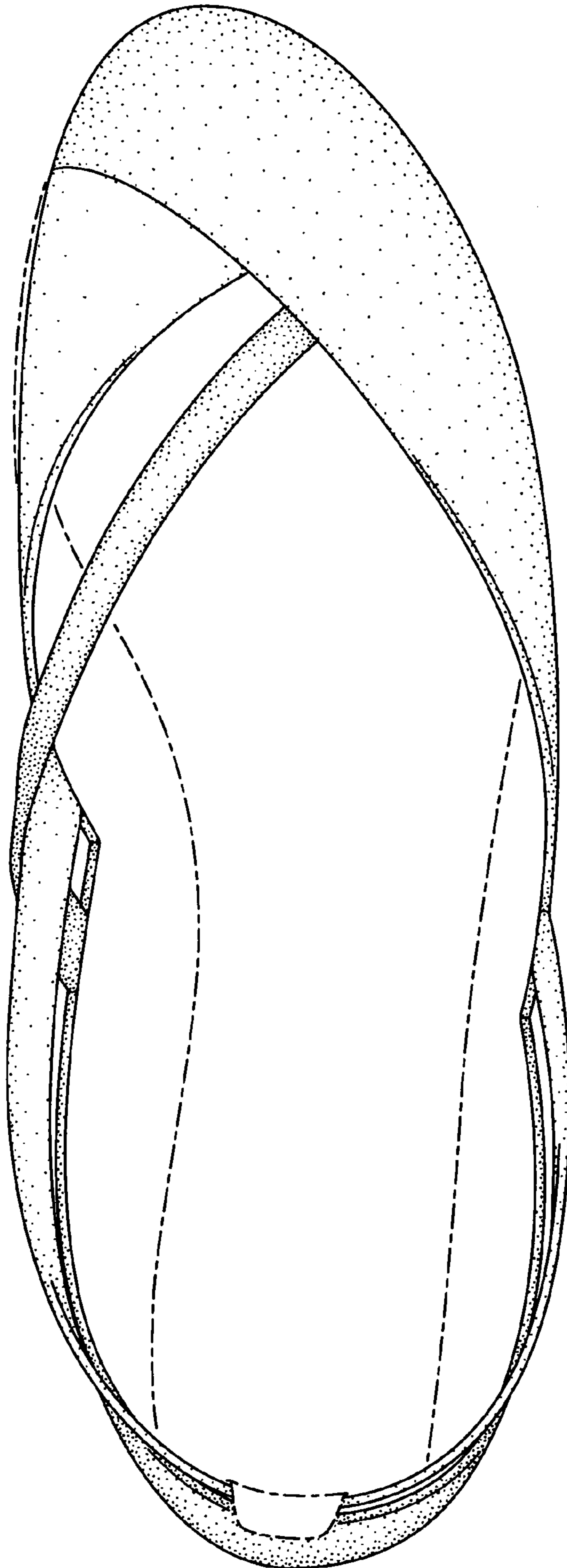

FIG. 6