

US00D544964S

(12) **United States Design Patent**  
**Hesselmann**

(10) **Patent No.:** **US D544,964 S**  
(45) **Date of Patent:** **\*\* Jun. 19, 2007**

- (54) **FENCE**
  - (75) Inventor: **Frank Hesselmann**, Berlin (DE)
  - (73) Assignee: **Firma Pool 22**, Berlin (DE)
  - (\*\*) Term: **14 Years**
  - (21) Appl. No.: **29/247,776**
  - (22) Filed: **Jul. 11, 2006**
  - (51) **LOC (8) Cl.** ..... **25-02**
  - (52) **U.S. Cl.** ..... **D25/38**
  - (58) **Field of Classification Search** ..... D25/38,  
D25/39, 50; 256/1, 24, 73, 19, 22, 32, 33,  
256/34, 35, 37
- See application file for complete search history.

(56) **References Cited**

U.S. PATENT DOCUMENTS

D252,406 S	*	7/1979	Dobias	.....	D25/38
5,415,380 A	*	5/1995	Sharp	.....	256/24
D369,420 S	*	4/1996	Haglund	.....	D25/38
D377,834 S	*	2/1997	Simpson	.....	D25/38
6,672,569 B2	*	1/2004	Deeley	.....	256/22

\* cited by examiner

*Primary Examiner*—Doris Clark

(74) *Attorney, Agent, or Firm*—Ursula B. Day

(57) **CLAIM**

The ornamental design for a fence, as shown and described.

**DESCRIPTION**

FIG. 1 is a perspective view of a fence showing my new design;  
 FIG. 2 is a front elevational view thereof;  
 FIG. 3 is a top plan view thereof;  
 FIG. 4 is bottom plan view thereof;  
 FIG. 5 is a perspective view of second embodiment of my new fence design;  
 FIG. 6 is a front elevational view of the second embodiment;  
 FIG. 7 is a perspective view of two single members of the fence;

FIG. 8 is top plan view of the two members of FIG. 7;  
 FIG. 9 is a bottom plan view of the two members of FIG. 7;  
 FIG. 10 is a front elevational view of the two members of FIG. 7.  
 FIG. 11 is a right side view one of the members of FIG. 7 with the left view being a mirror image thereof;  
 FIG. 12 is a perspective view of a third embodiment of the new fence design;  
 FIG. 13 is a front elevational view of the embodiment of FIG. 12;  
 FIG. 14 is a perspective view of two single members of the new fence design;  
 FIG. 15 is a front elevational view of the two members of FIG. 14;  
 FIG. 16 is a top plan view of the two members of FIG. 14;  
 FIG. 17 is a bottom plan view of the two members of FIG. 14;  
 FIG. 18 is a left side view of one of the fence members with the right side being a mirror image thereof; and  
 FIG. 19 is a left side view of another one of the fence members with the right side being a mirror image thereof.  
 FIG. 20 is a perspective view of a fourth embodiment of the new fence design;  
 FIG. 21 is a front elevational view of the embodiment of FIG. 20;  
 FIG. 22 is a top plan view of the embodiment of FIG. 20;  
 FIG. 23 is a bottom plan view of the embodiment of FIG. 20;  
 FIG. 24 is a perspective view of a fifth embodiment of the new fence design;  
 FIG. 25 is a front elevational view of the embodiment of FIG. 24;  
 FIG. 26 is a perspective view of two single members of the new fence design;  
 FIG. 27 is a front elevational view of the two single members of FIG. 26;  
 FIG. 28 is a top plan view of the members of FIG. 26;  
 FIG. 29 is a bottom plan view of the members of FIG. 26;  
 FIG. 30 is a right side view of one of the members of FIG. 26, with the left side view being a mirror image; and,  
 FIG. 31 is a right side image of the other one of the members of FIG. 26, with the left side being a mirror image thereof.

**1 Claim, 13 Drawing Sheets**

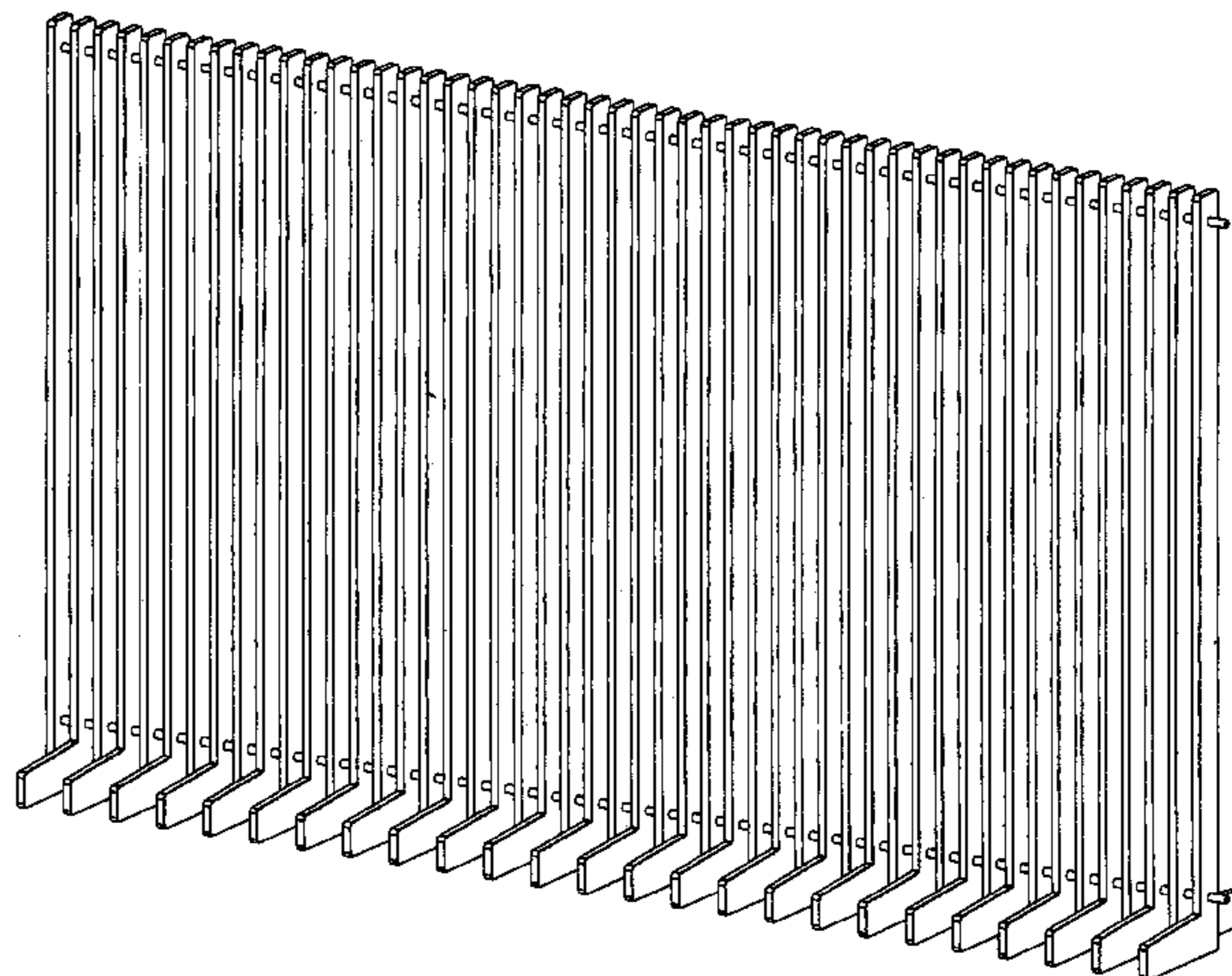

Fig. 1

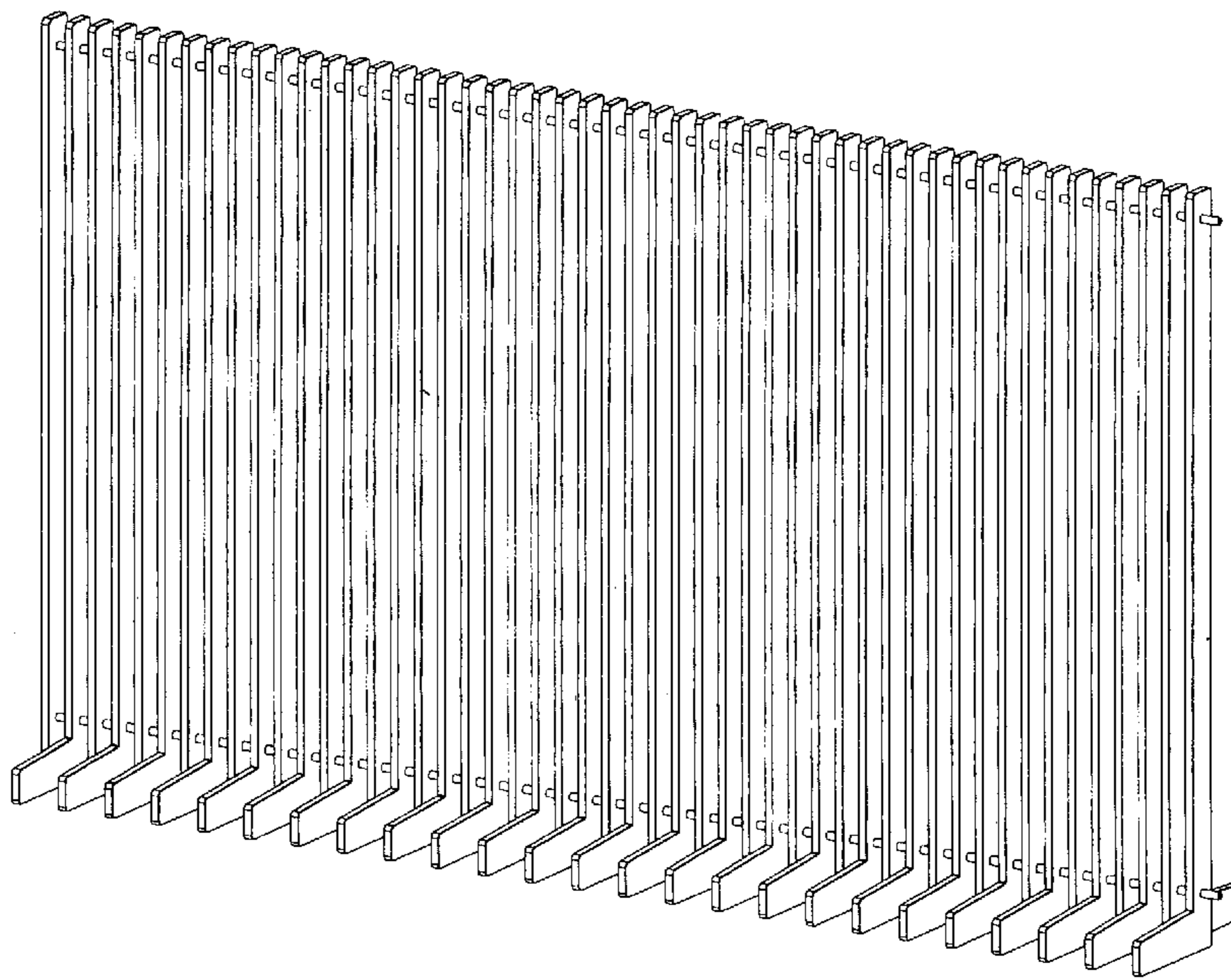

Fig. 3

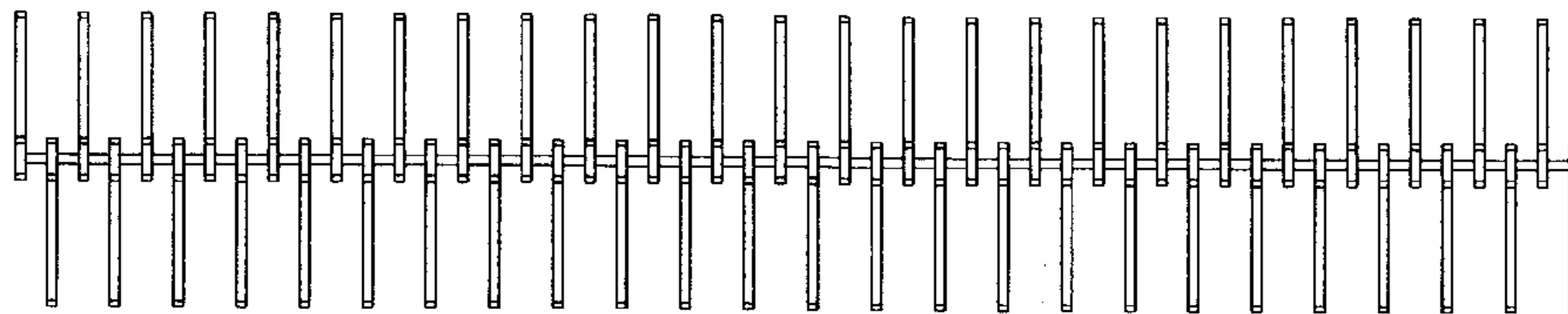

Fig. 2

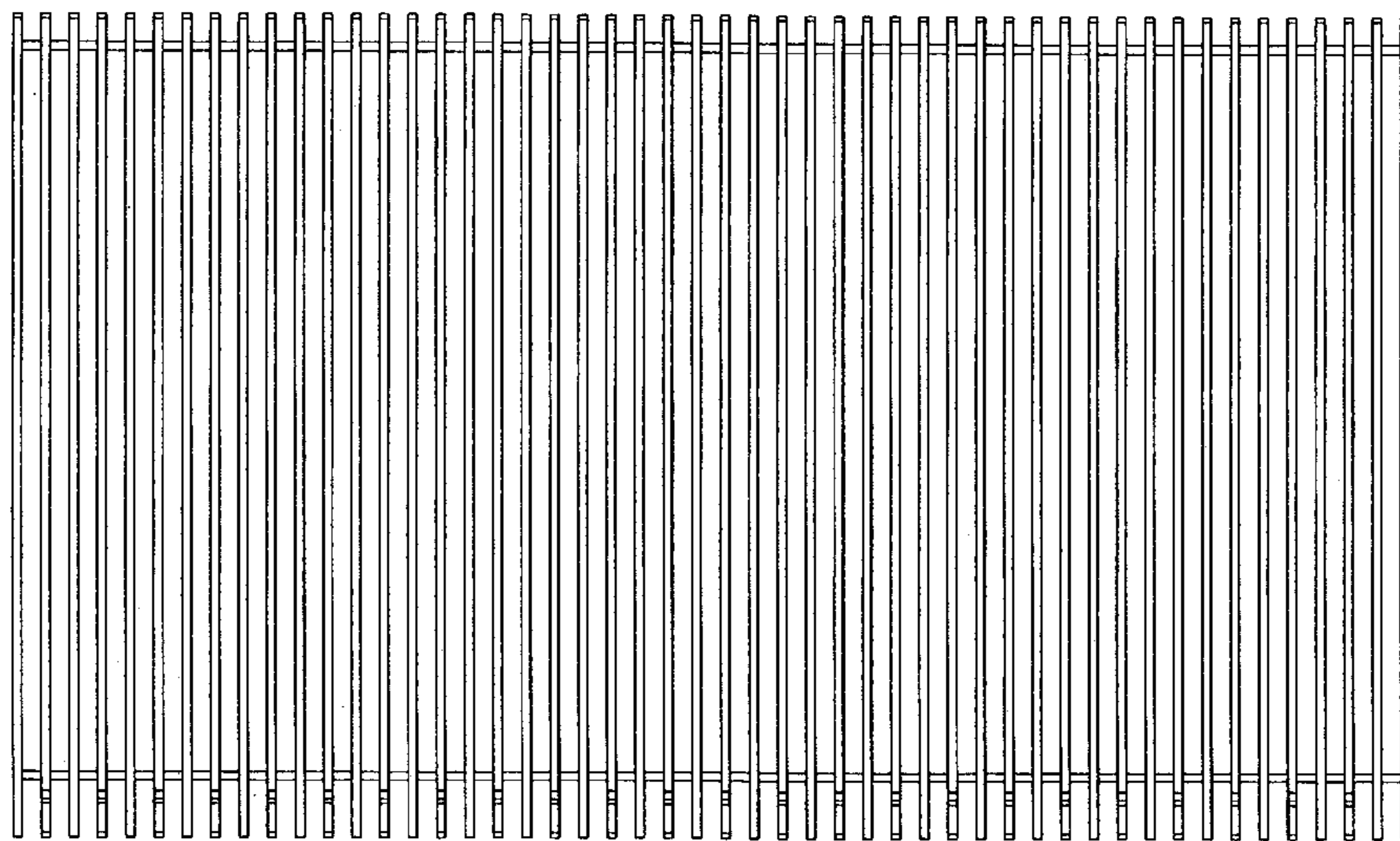

Fig. 4

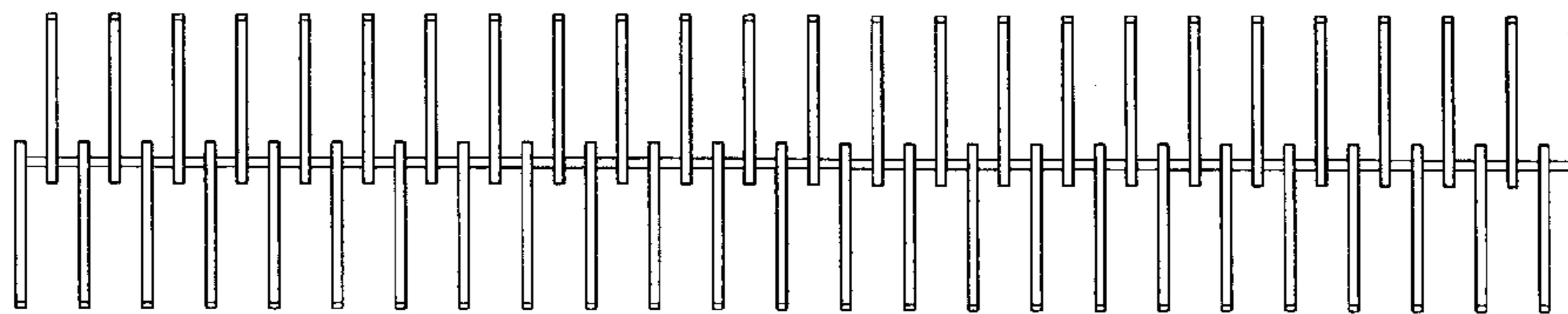

Fig. 5

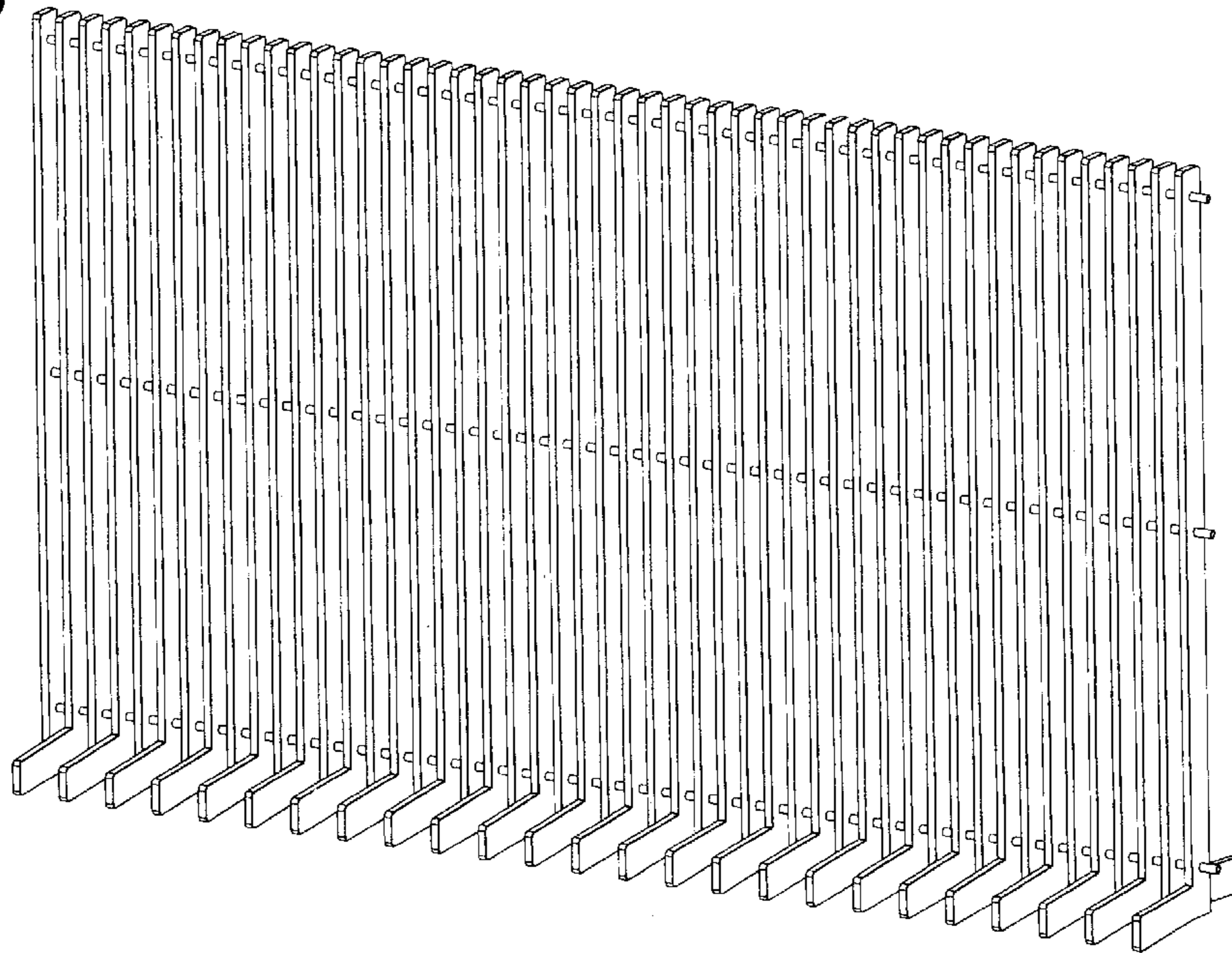
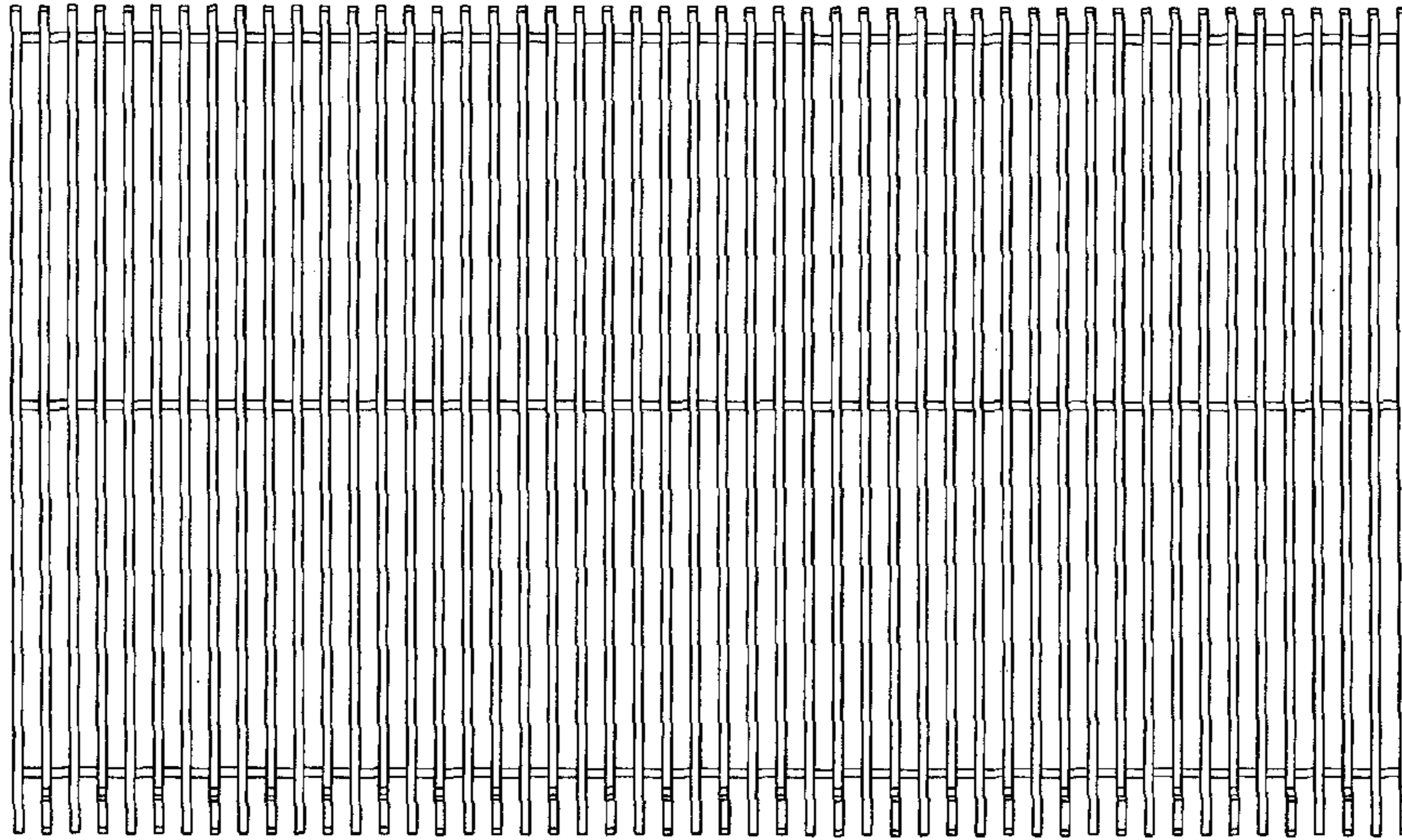

Fig. 6



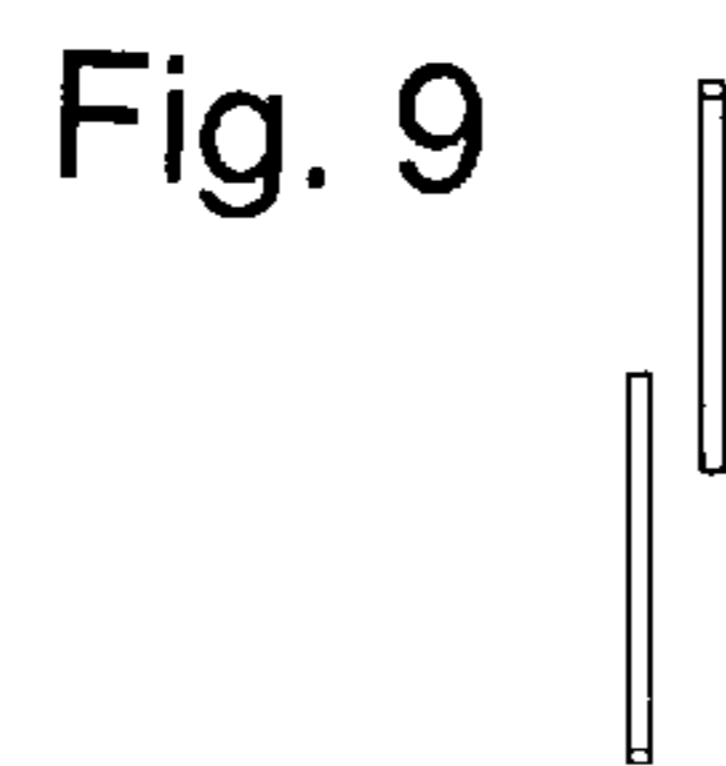
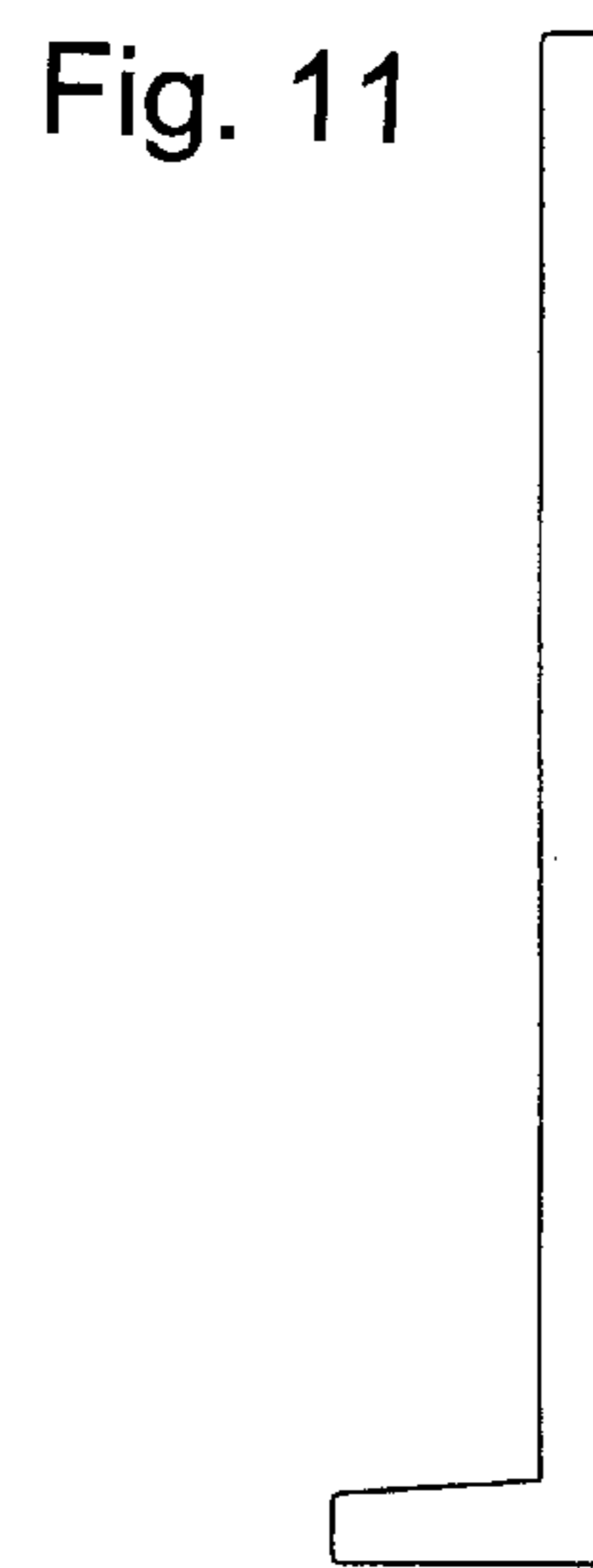
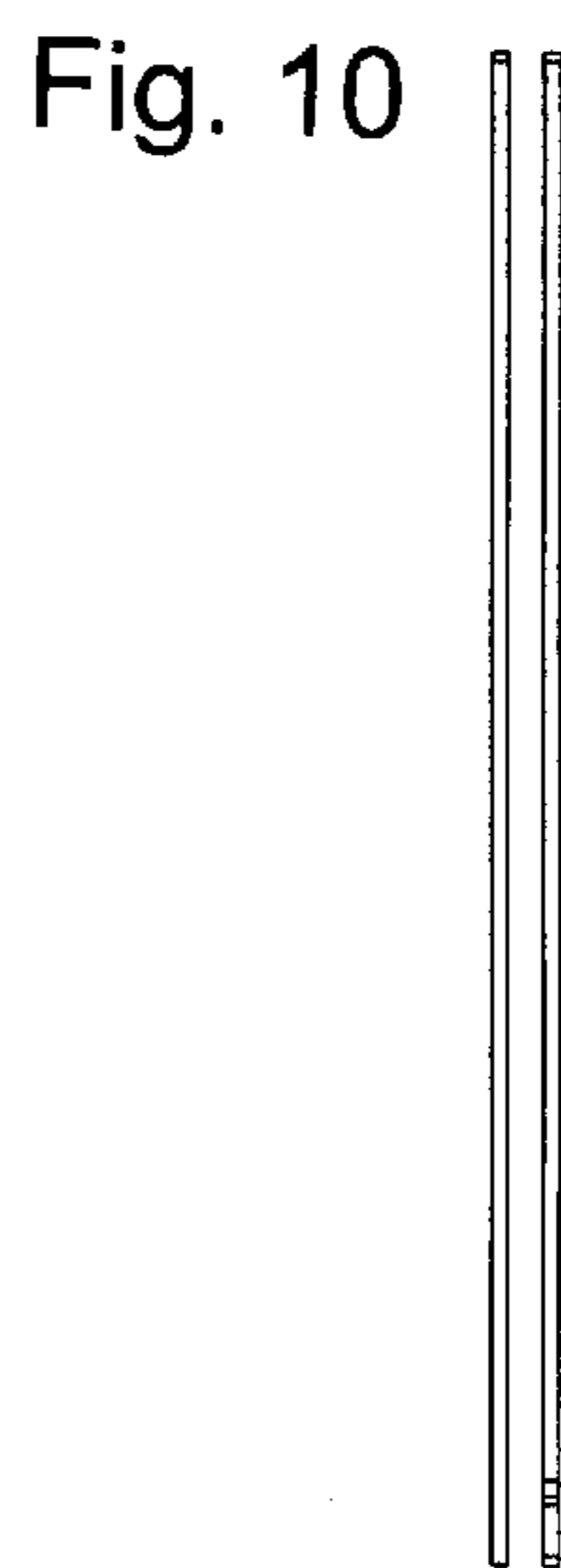
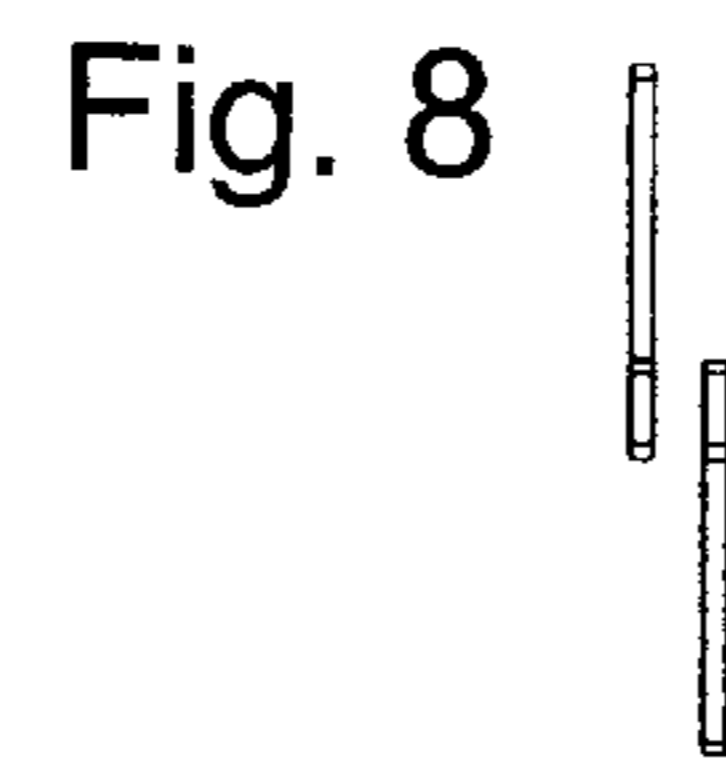
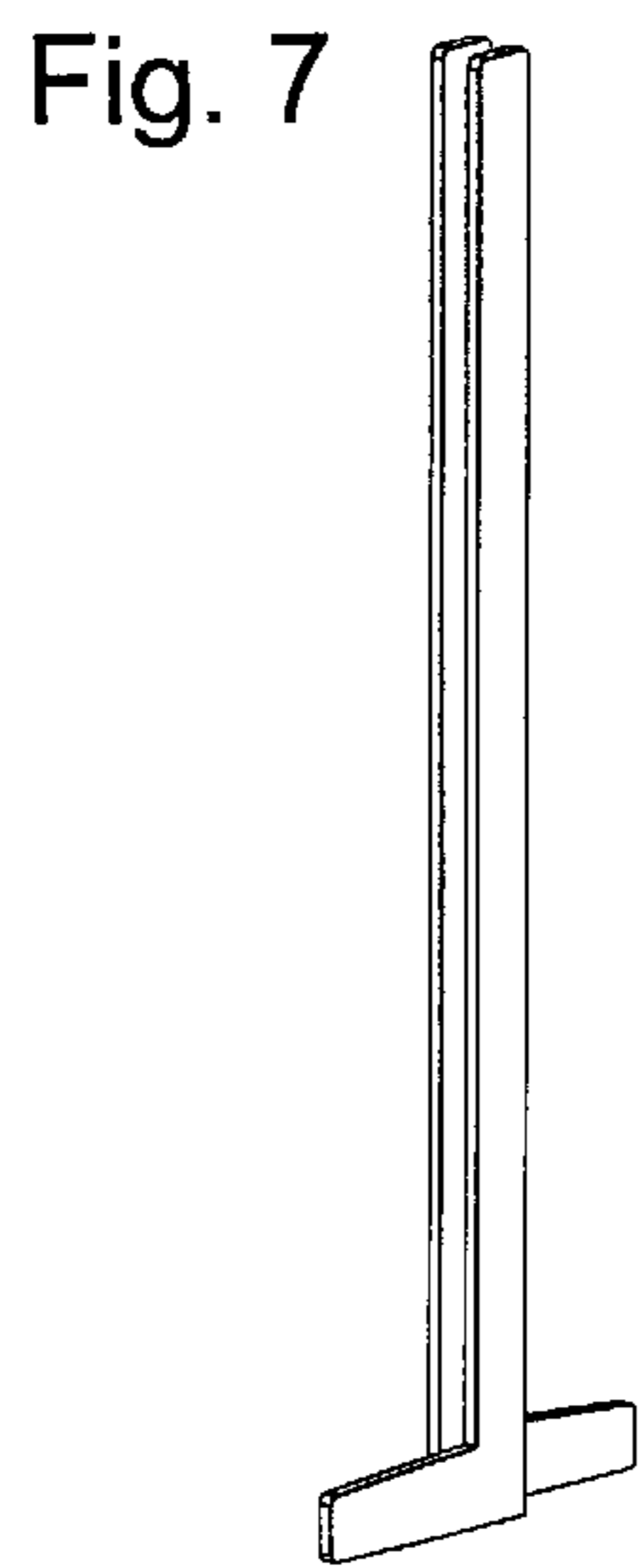

Fig. 12

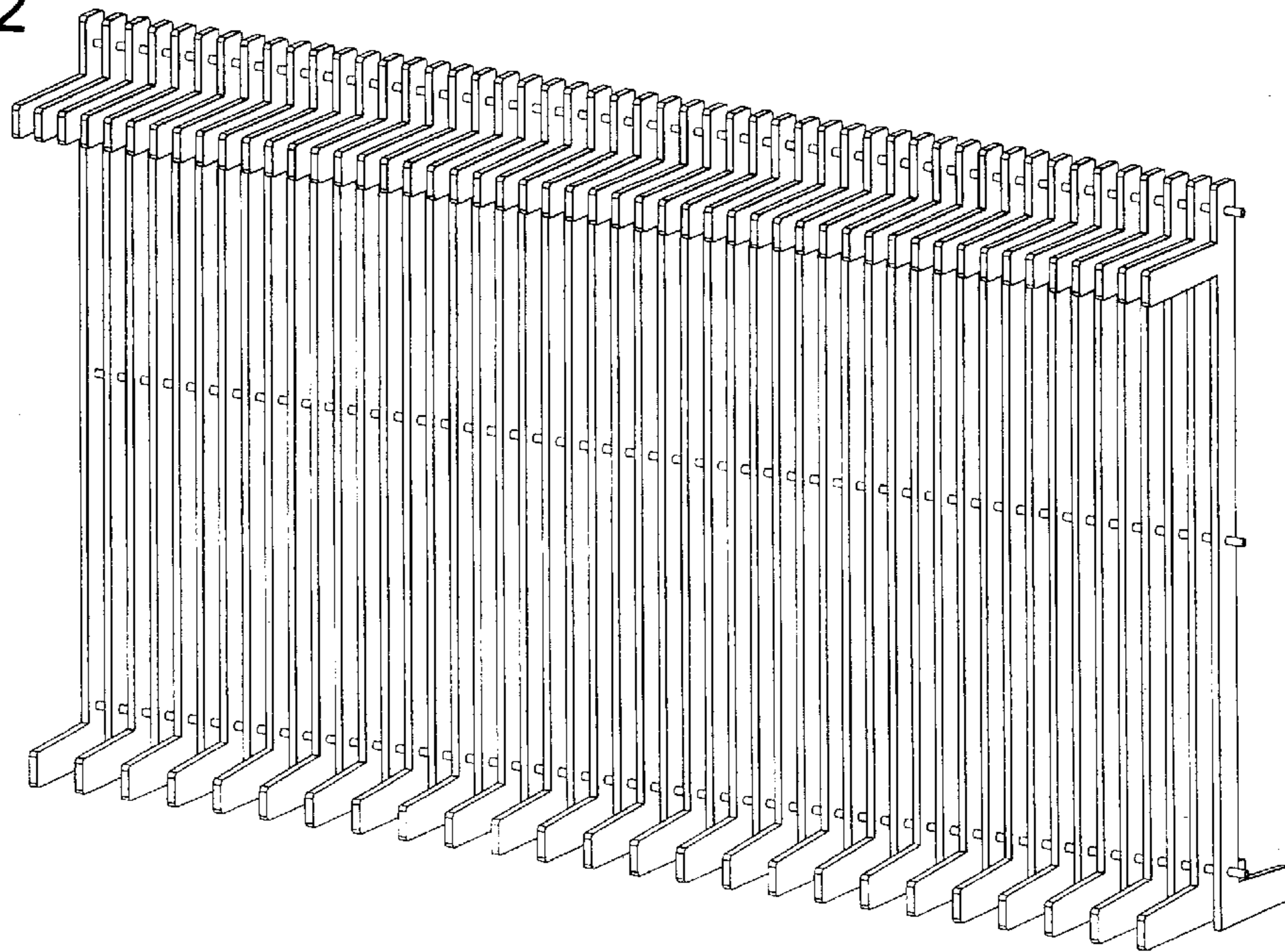

Fig. 13

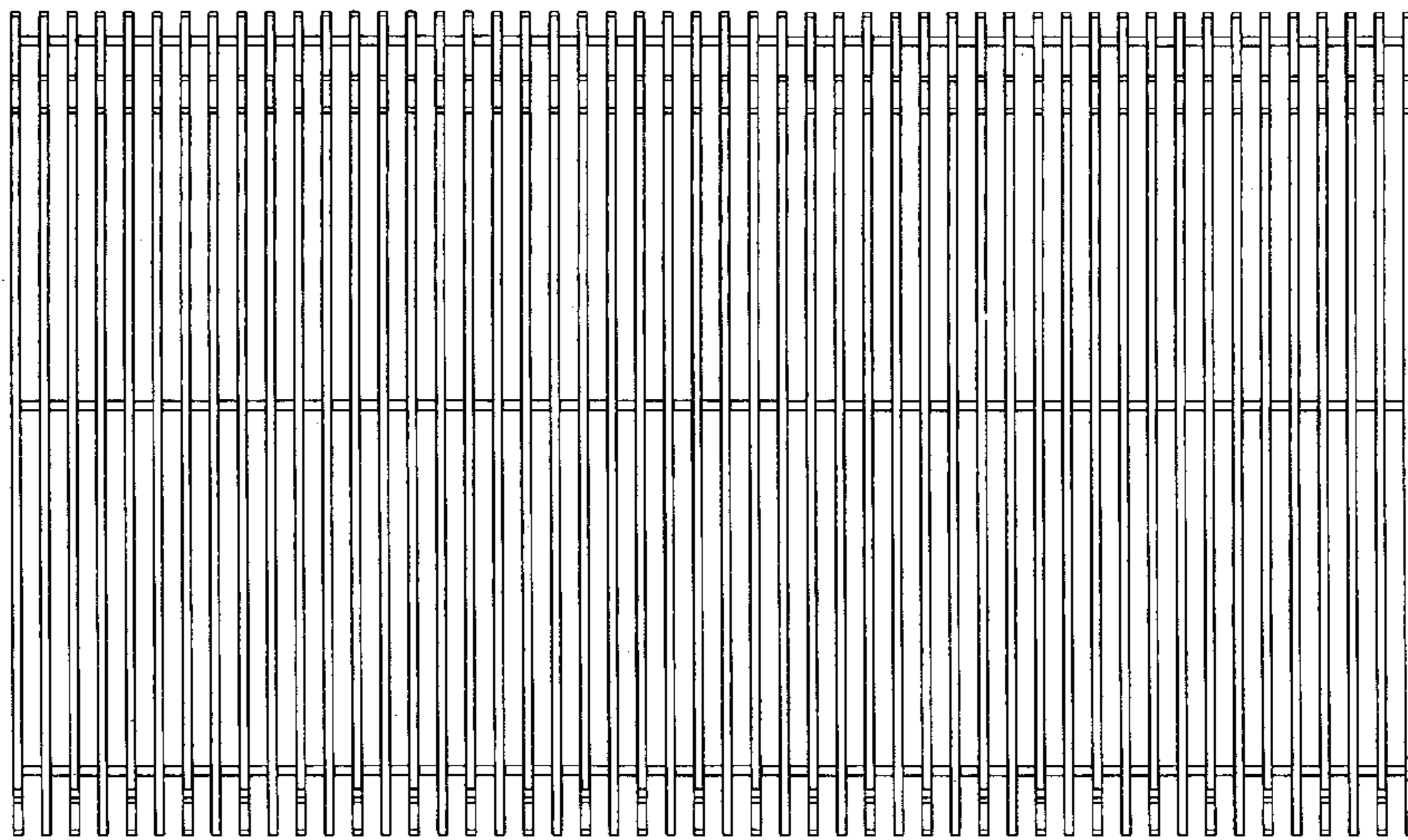



Fig. 14

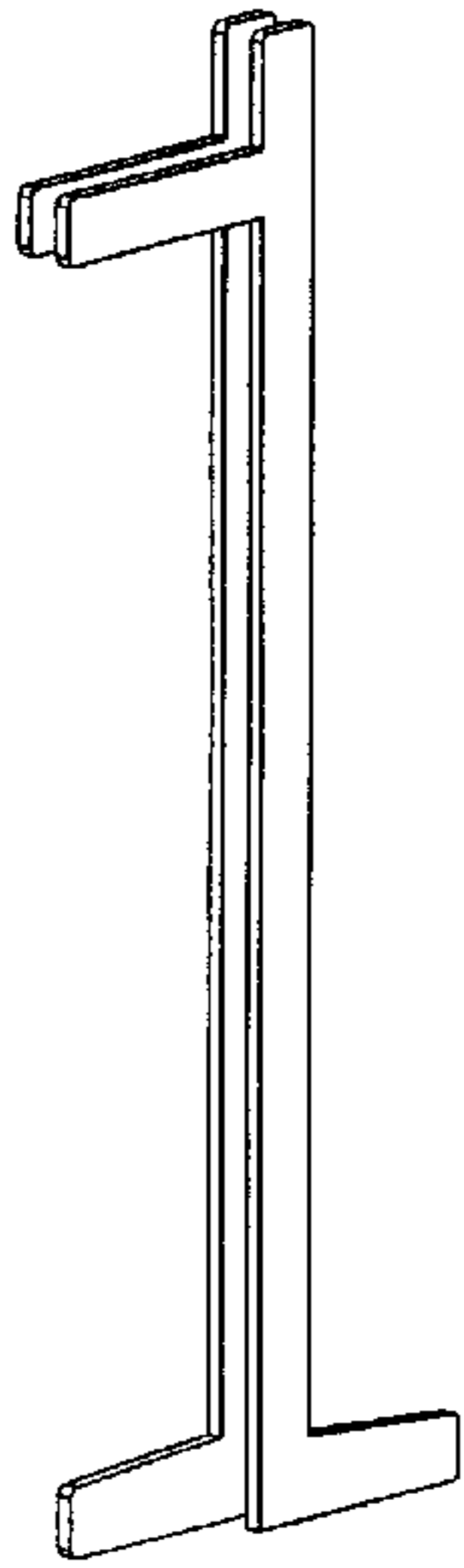

Fig. 16

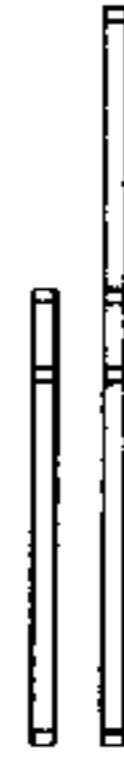

Fig. 15



Fig. 17



Fig. 18

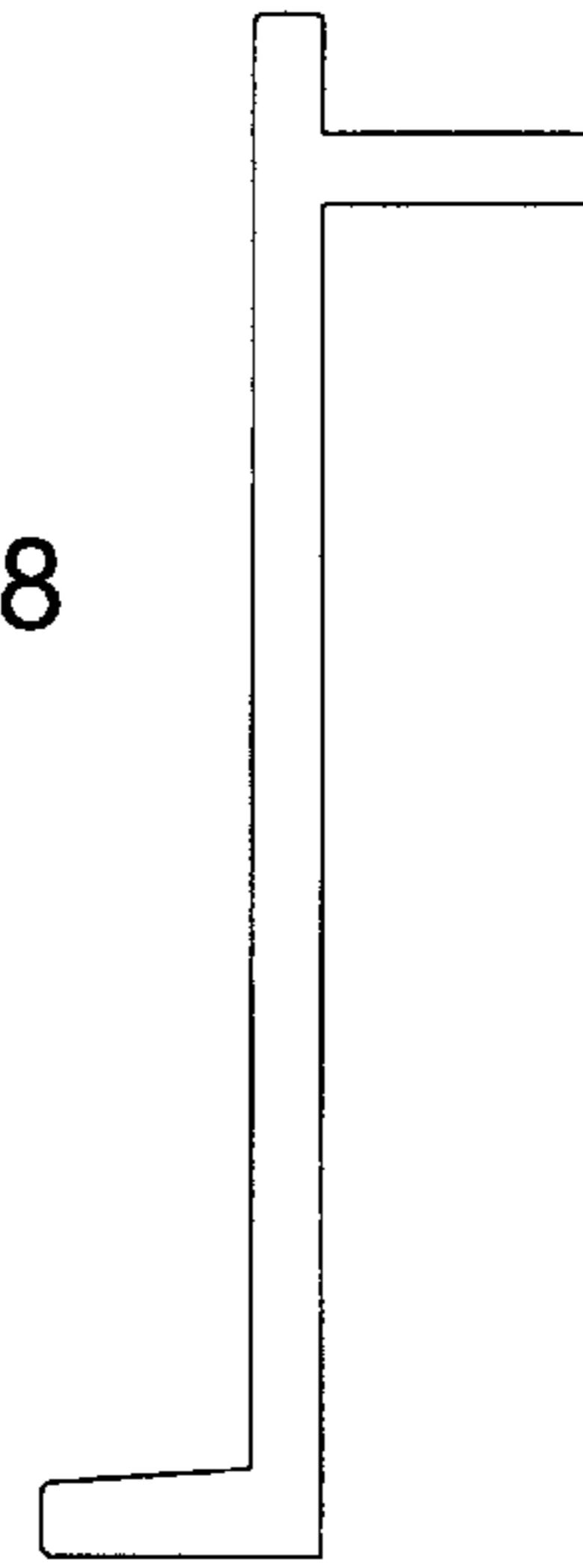

Fig. 19

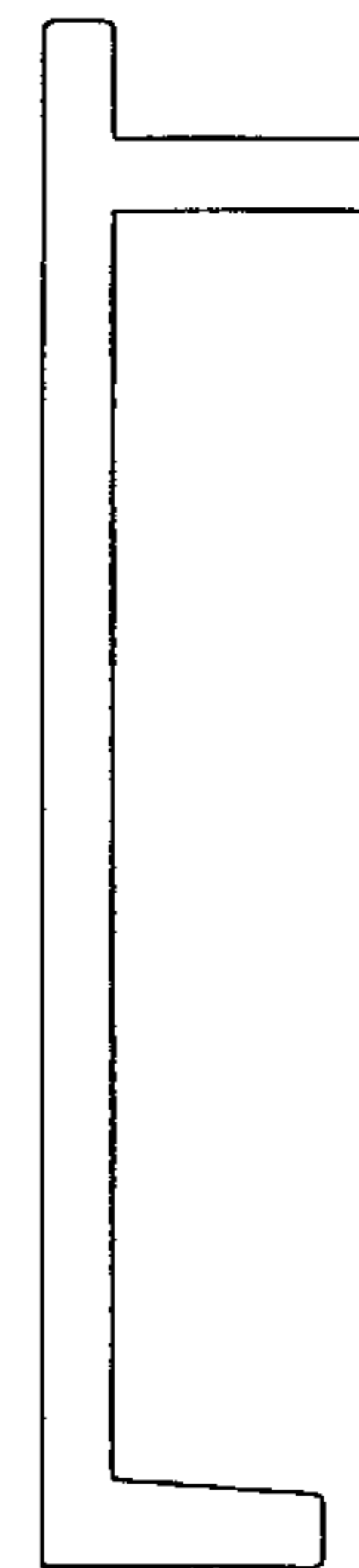

Fig. 20

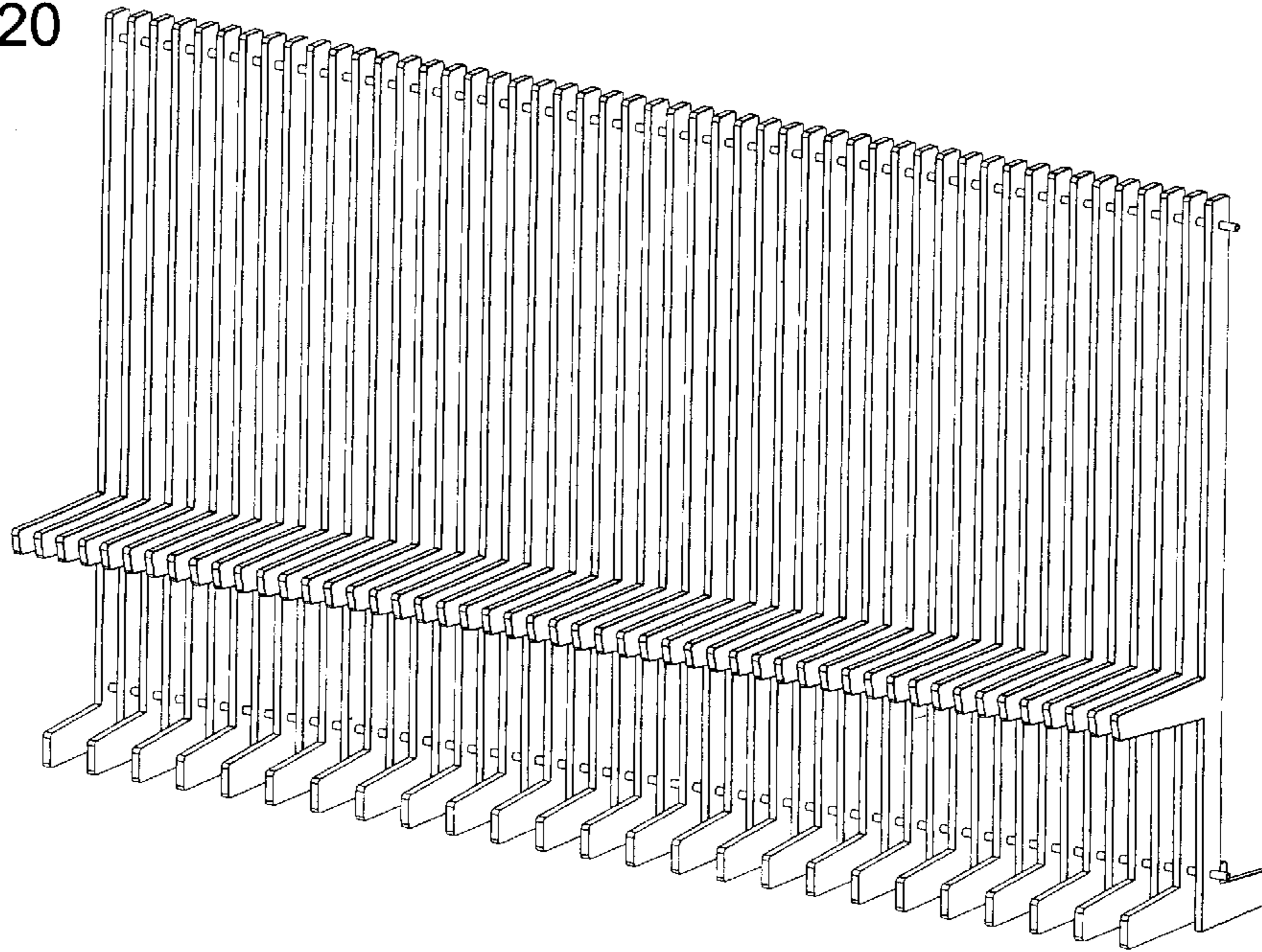

Fig. 22

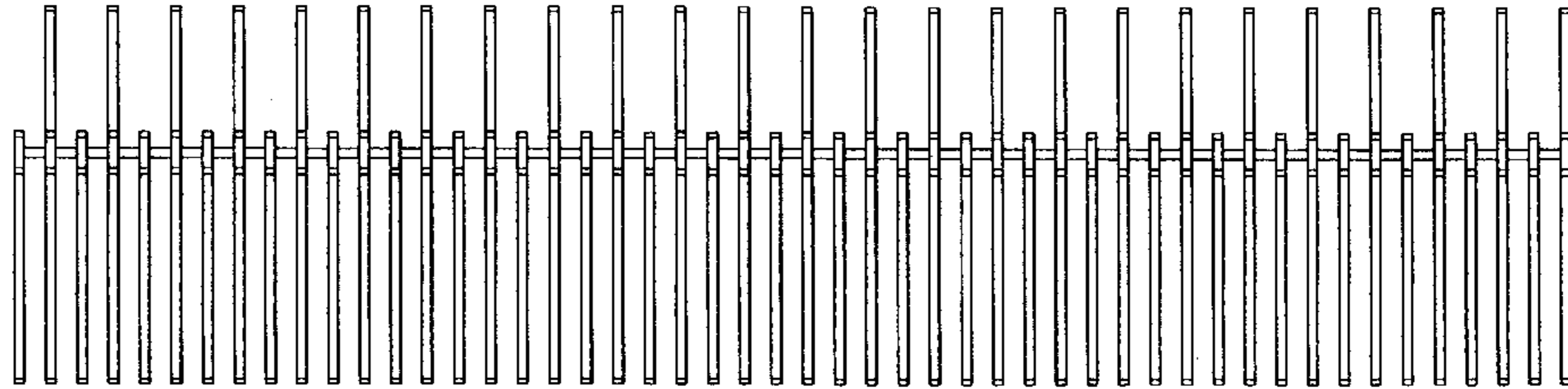

Fig. 21

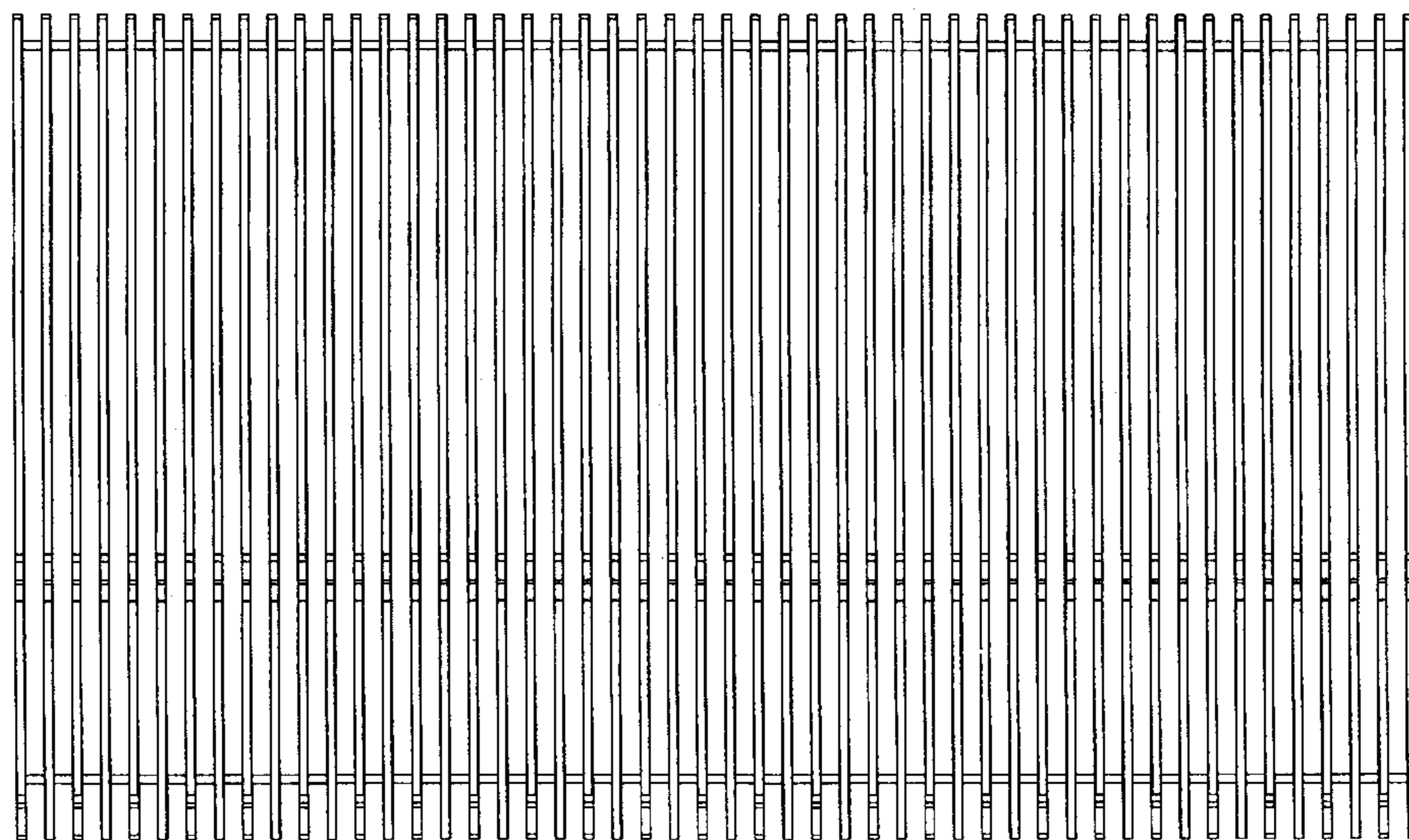

Fig. 23

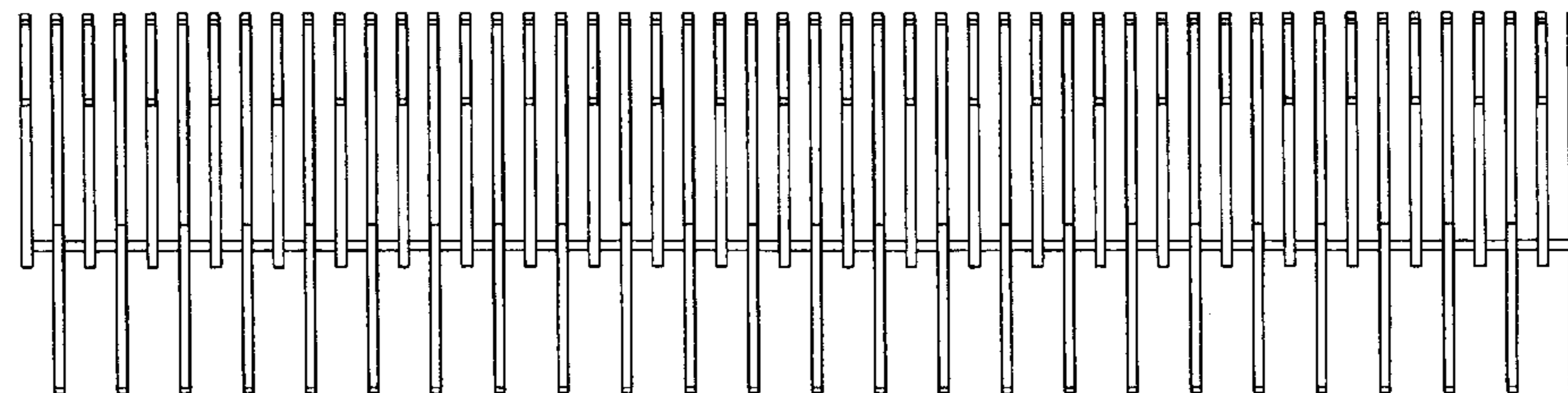

Fig. 24

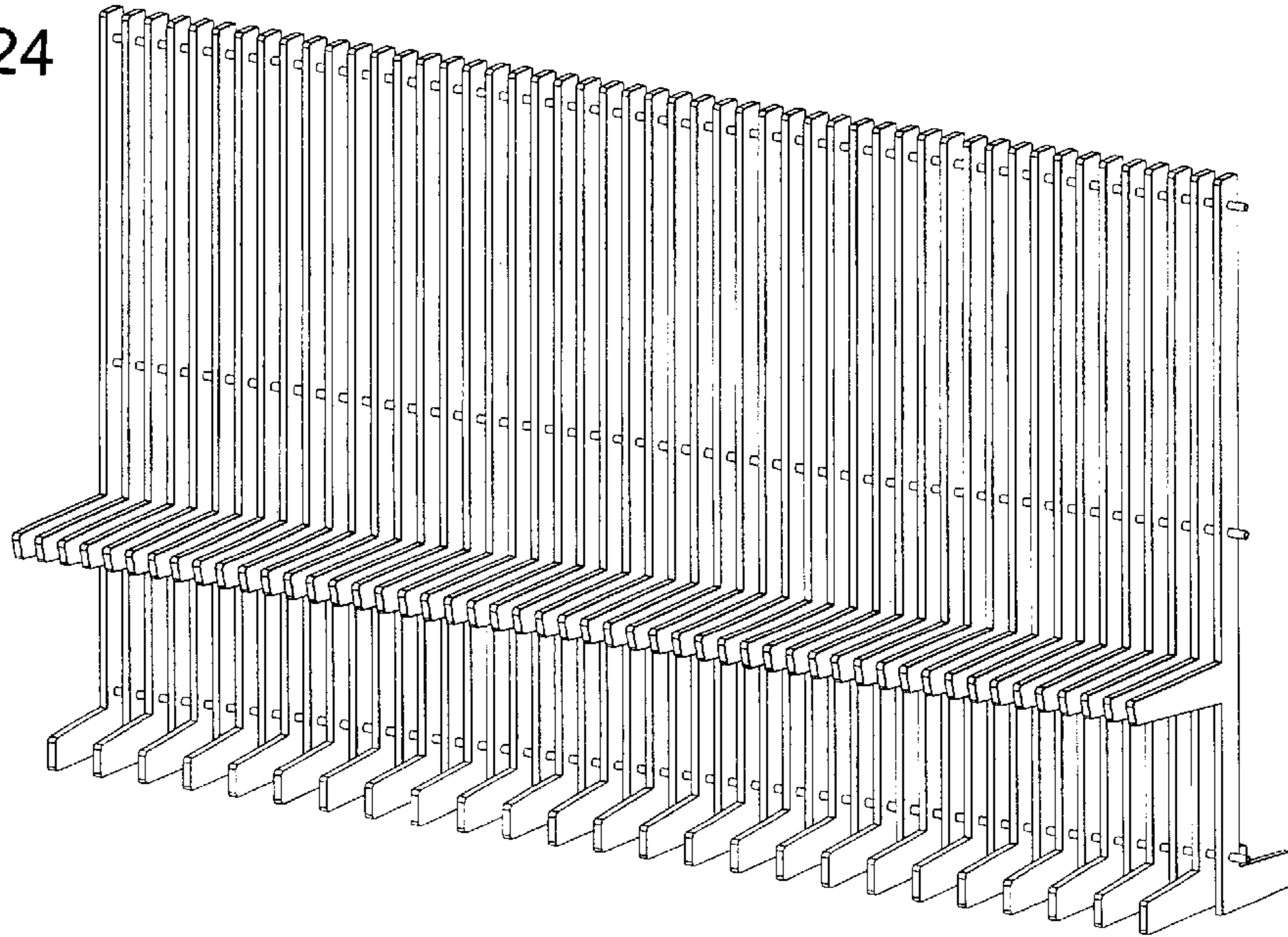
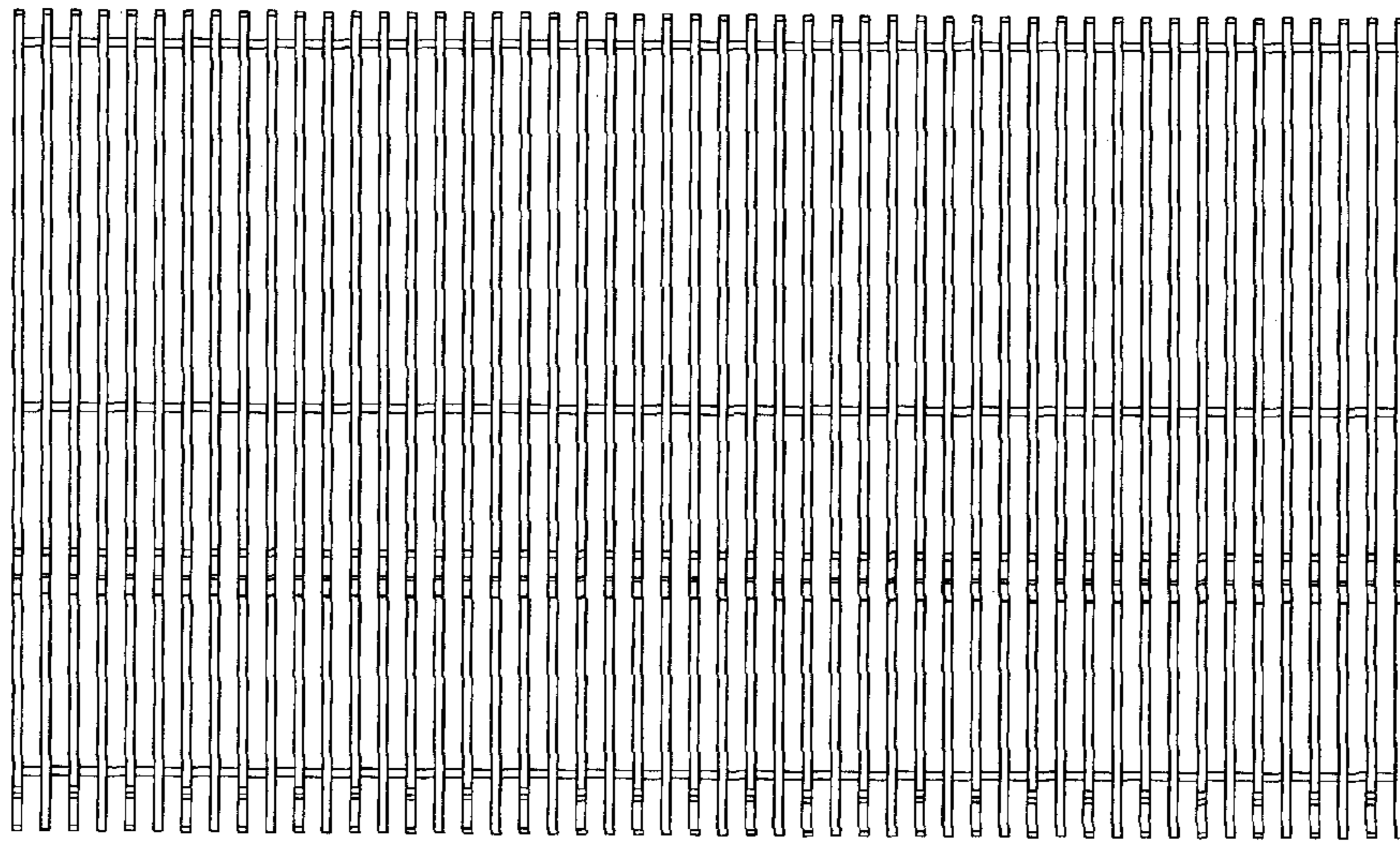

Fig. 25



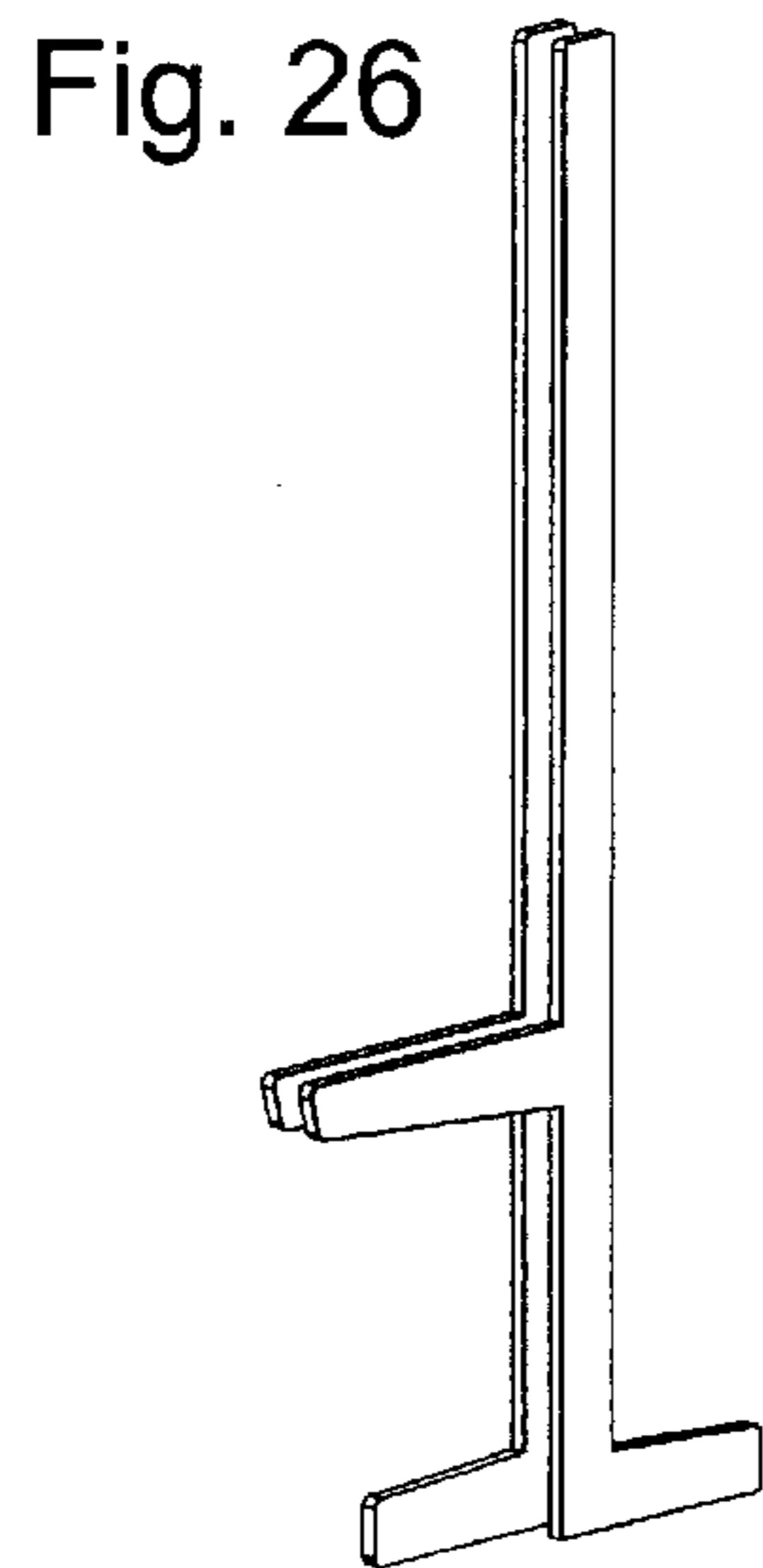

Fig. 28



Fig. 27



Fig. 30

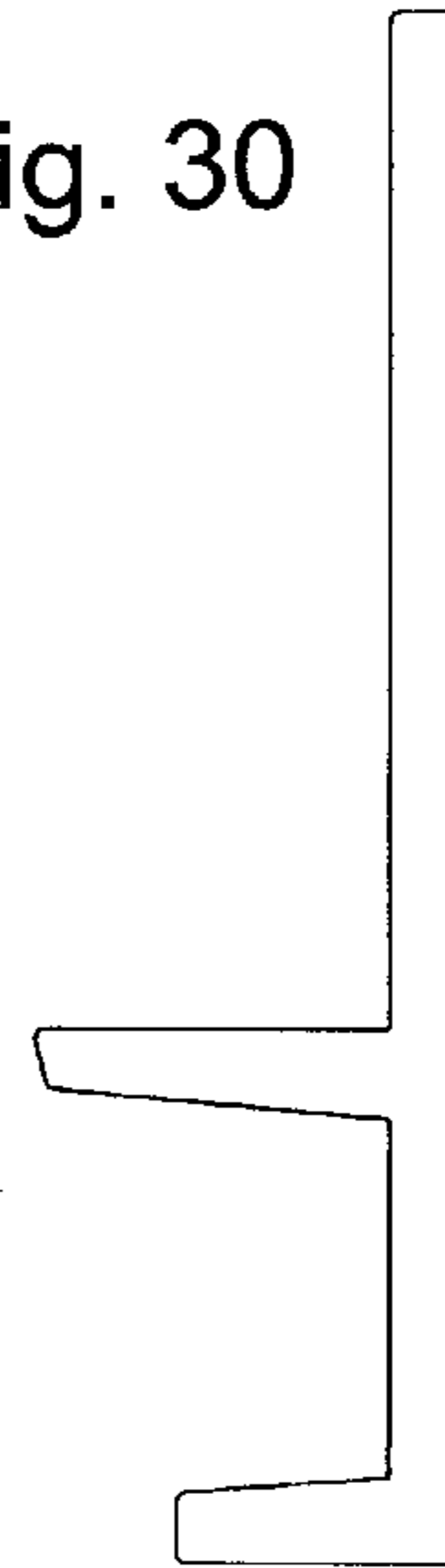

Fig. 31

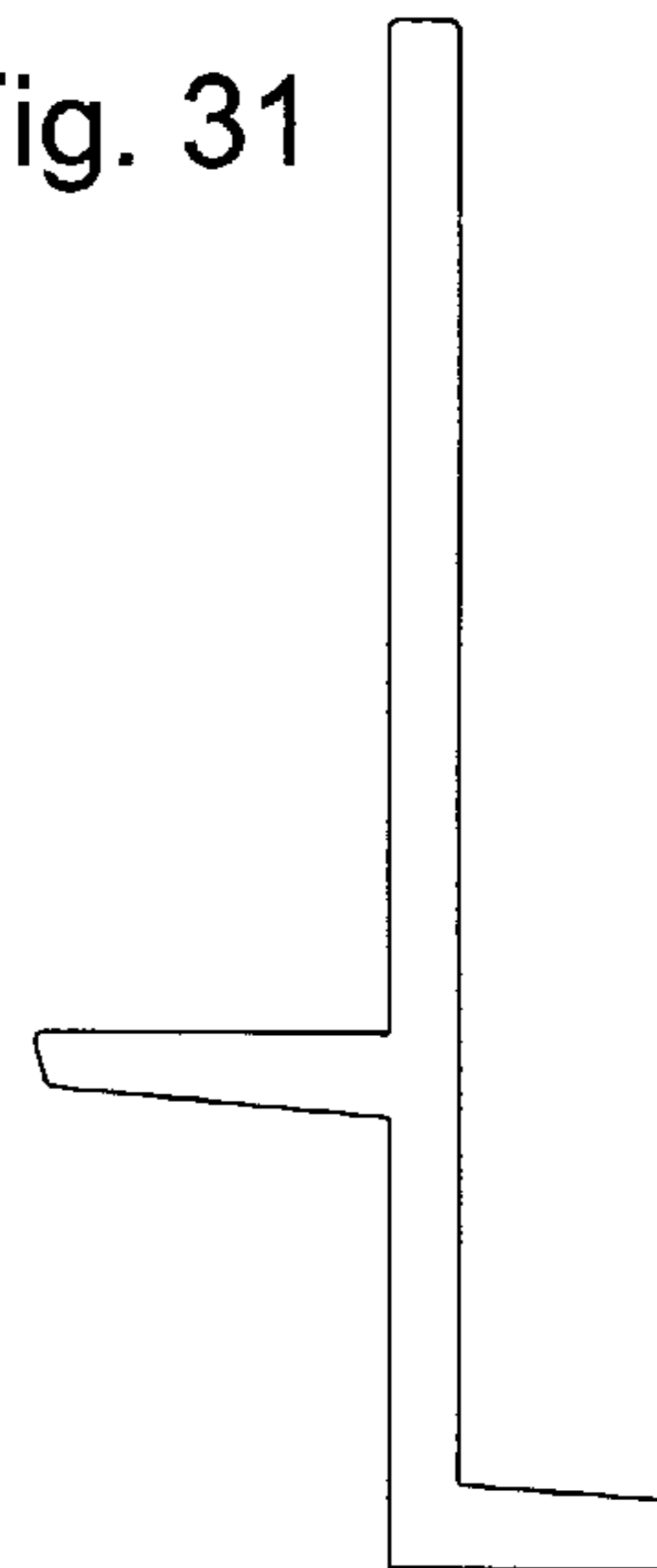

Fig. 29

