



US00D544822S

(12) **United States Design Patent**  
**Walbey, Jr.**

(10) **Patent No.:** **US D544,822 S**  
(45) **Date of Patent:** **\*\* Jun. 19, 2007**

- (54) **VEHICLE-WHEEL FRONT FACE**
- (75) Inventor: **Gaylon G. Walbey, Jr.**, Livingston, TX (US)
- (73) Assignee: **Mobile Hi-Tech Wheels**, La Palma, CA (US)
- (\*\*) Term: **14 Years**
- (21) Appl. No.: **29/268,216**
- (22) Filed: **Oct. 31, 2006**
- (51) **LOC (8) Cl.** ..... **12-16**
- (52) **U.S. Cl.** ..... **D12/211**
- (58) **Field of Classification Search** ..... D12/204-213;  
301/37.101, 64.101, 65  
See application file for complete search history.

(56) **References Cited**

**U.S. PATENT DOCUMENTS**

D422,258 S *	4/2000	Hale, Jr. ....	D12/211
D428,846 S *	8/2000	Yoshida et al. ....	D12/211
D463,769 S *	10/2002	Chung ....	D12/211
D475,674 S *	6/2003	Baumgartner ....	D12/211
D486,437 S *	2/2004	Hieke ....	D12/211
D487,418 S *	3/2004	Hieke ....	D12/211
D503,919 S *	4/2005	Cahyono ....	D12/211
D509,175 S *	9/2005	Marji ....	D12/209
D510,554 S *	10/2005	Markefka ....	D12/211
D516,988 S *	3/2006	Laengerer ....	D12/211
D521,920 S *	5/2006	Phillips ....	D12/209
D527,335 S *	8/2006	Kim ....	D12/211

D531,105 S *	10/2006	Martin ....	D12/209
D533,825 S *	12/2006	Baumgartner ....	D12/211
D534,473 S *	1/2007	Bernoni ....	D12/211
D535,238 S *	1/2007	Kim ....	D12/209
D536,654 S *	2/2007	Moruzzi ....	D12/211

\* cited by examiner

*Primary Examiner*—Stacia Cadmus

(74) *Attorney, Agent, or Firm*—Christie, Parker & Hale, LLP.

(57) **CLAIM**

The ornamental design for vehicle-wheel front face, as shown and described.

**DESCRIPTION**

FIG. 1 is a perspective view of a vehicle-wheel front face according to my new design;

FIG. 2 is a front elevational view thereof;

FIG. 3 is a side elevational view thereof;

FIG. 4 is a perspective view of a second embodiment of the vehicle-wheel front face;

FIG. 5 is a front elevational view of the design shown in FIG. 4; and,

FIG. 6 is a side elevational view of the design shown in FIG. 4.

Portions of the wheel depicted in broken line are for illustrative purposes only, and form no part of the claimed design.

**1 Claim, 6 Drawing Sheets**

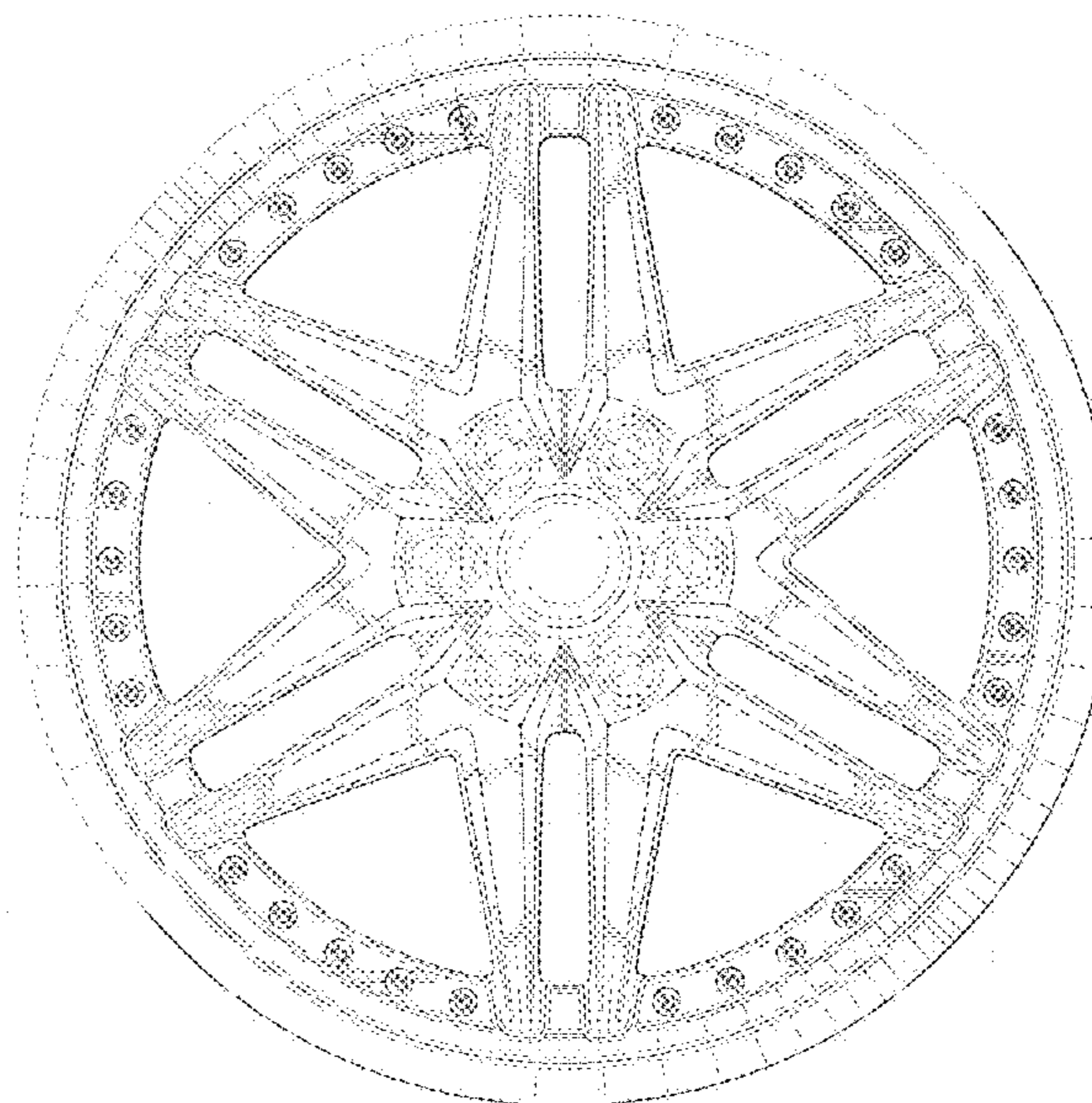
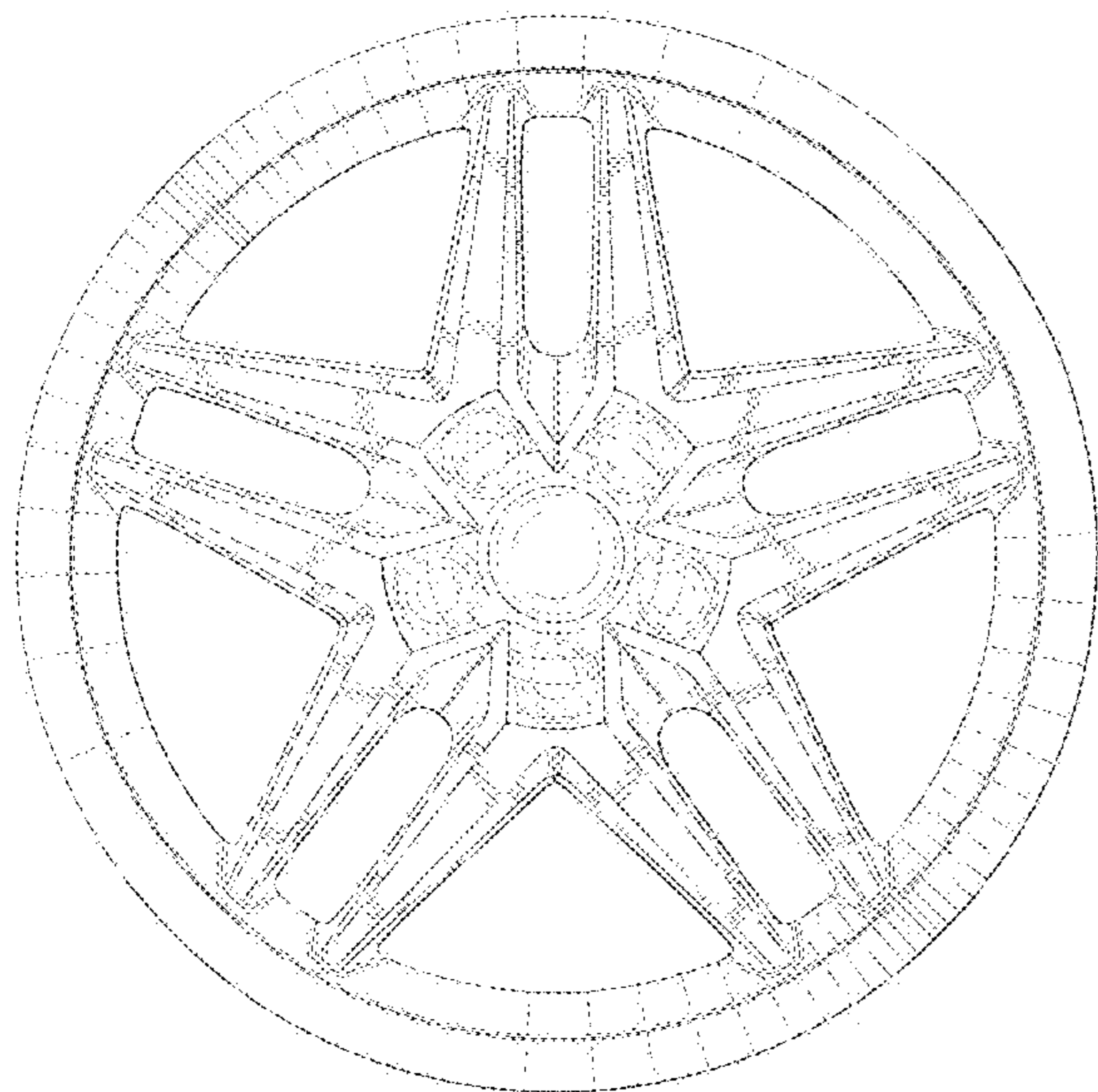

FIG. 1

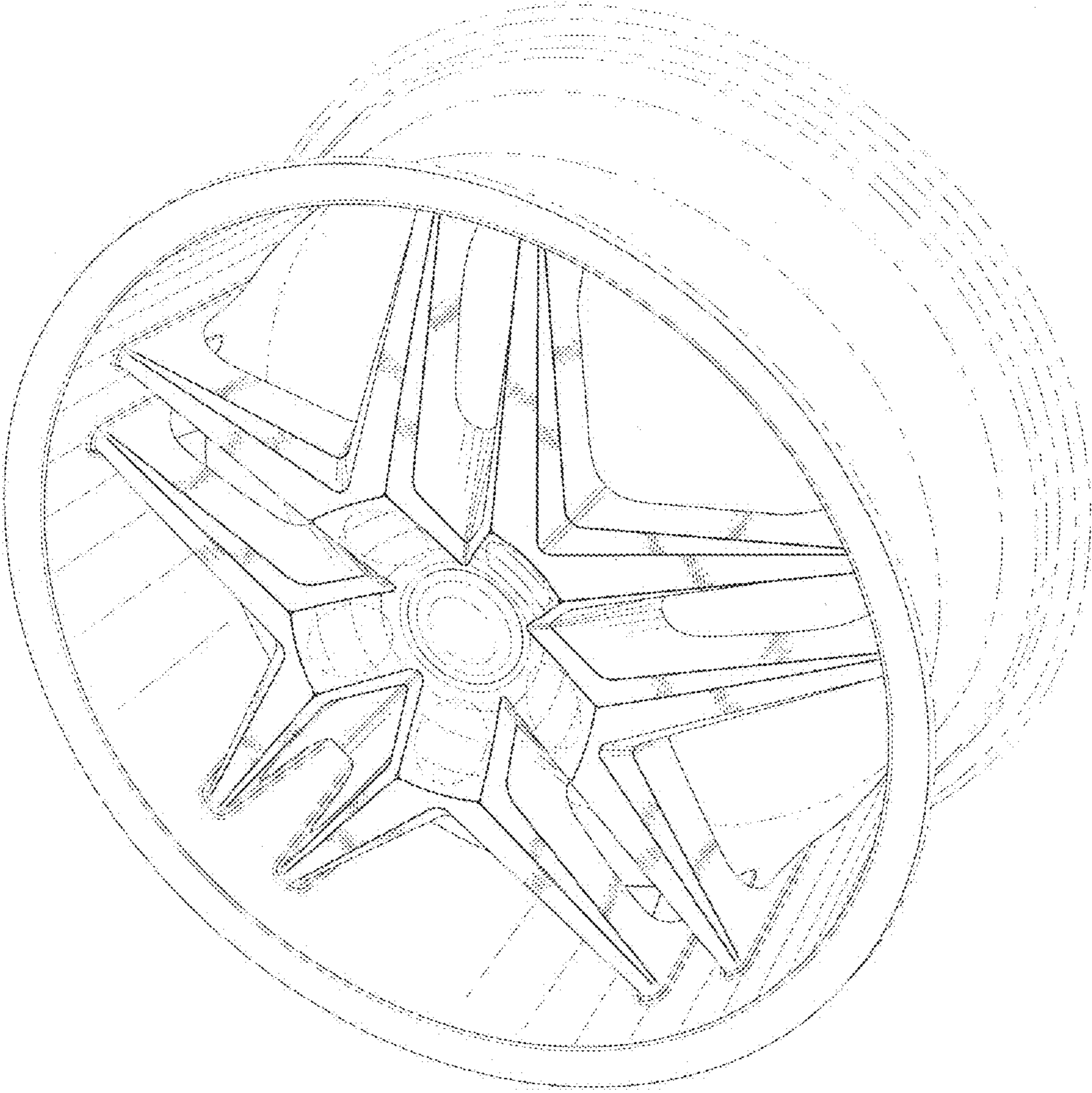

FIG. 2

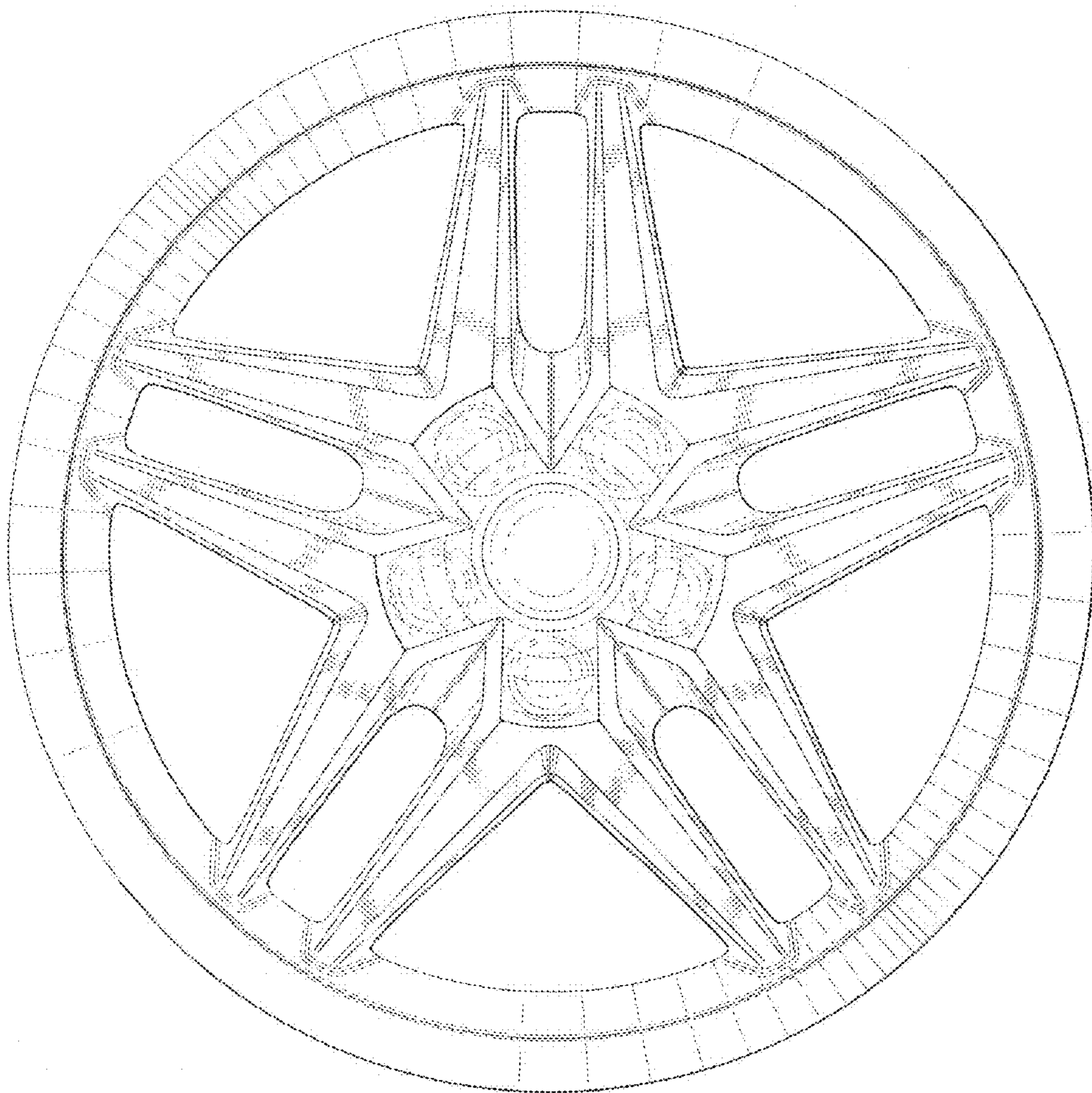

FIG. 3

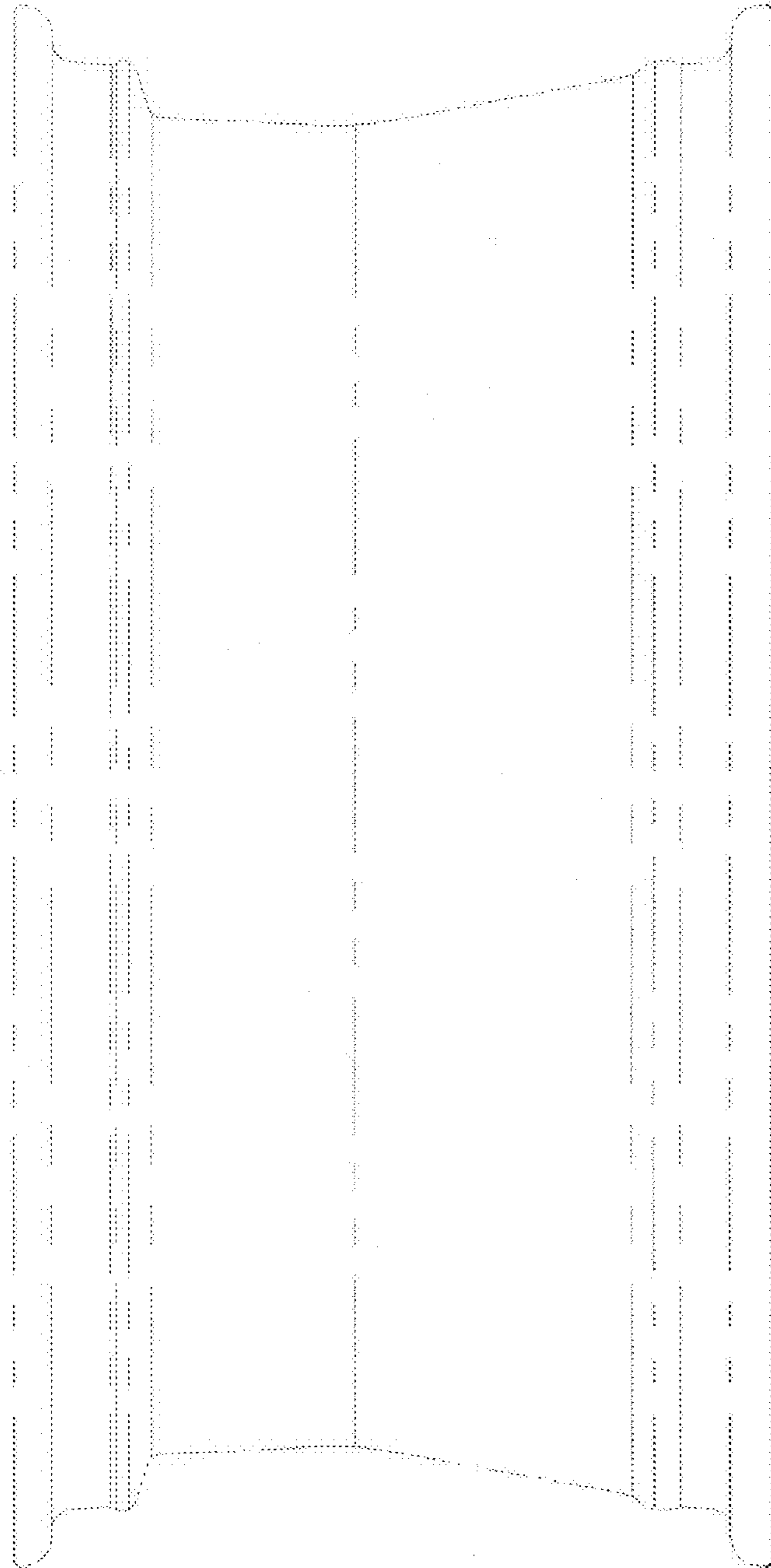

FIG. 4

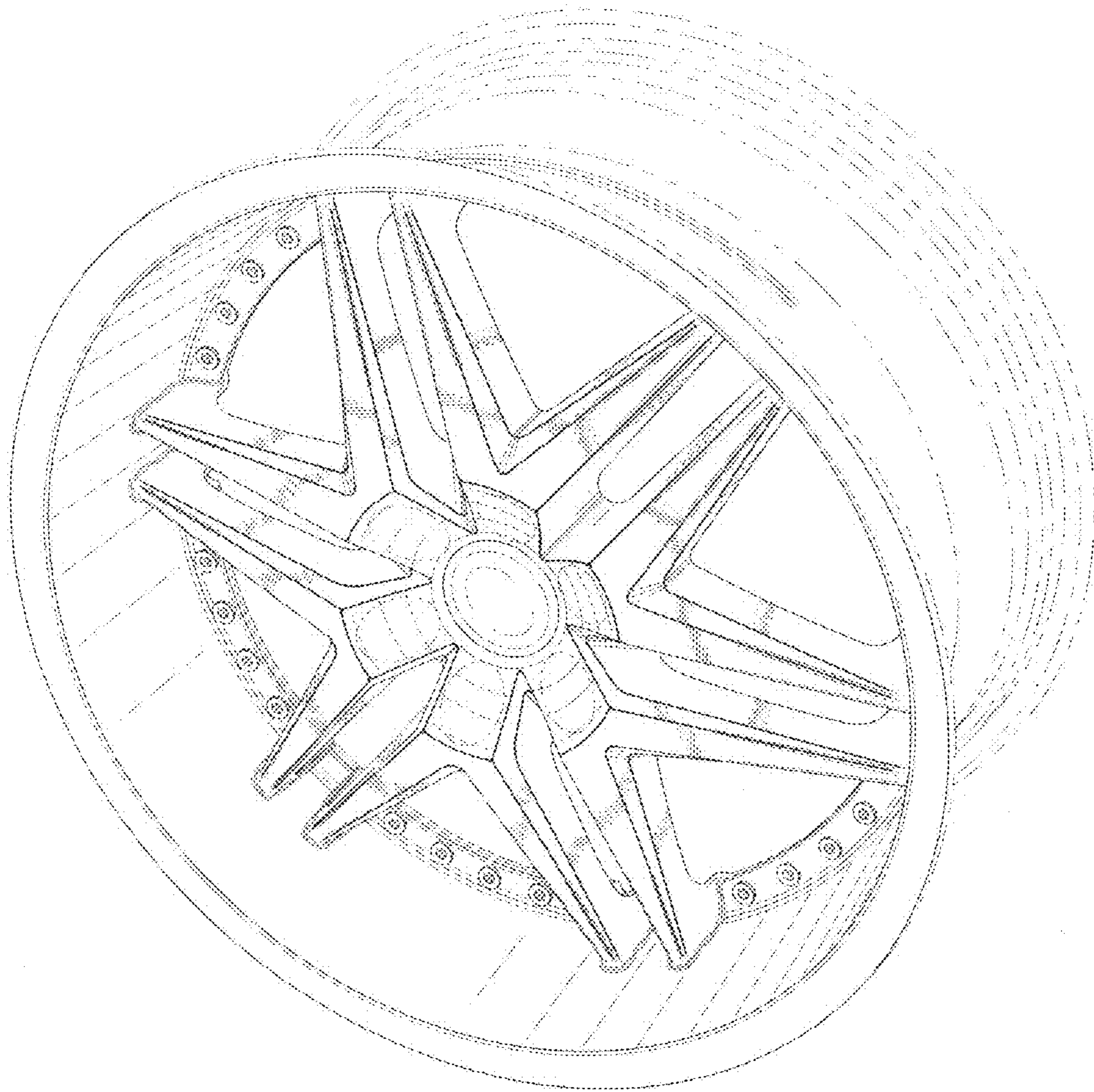
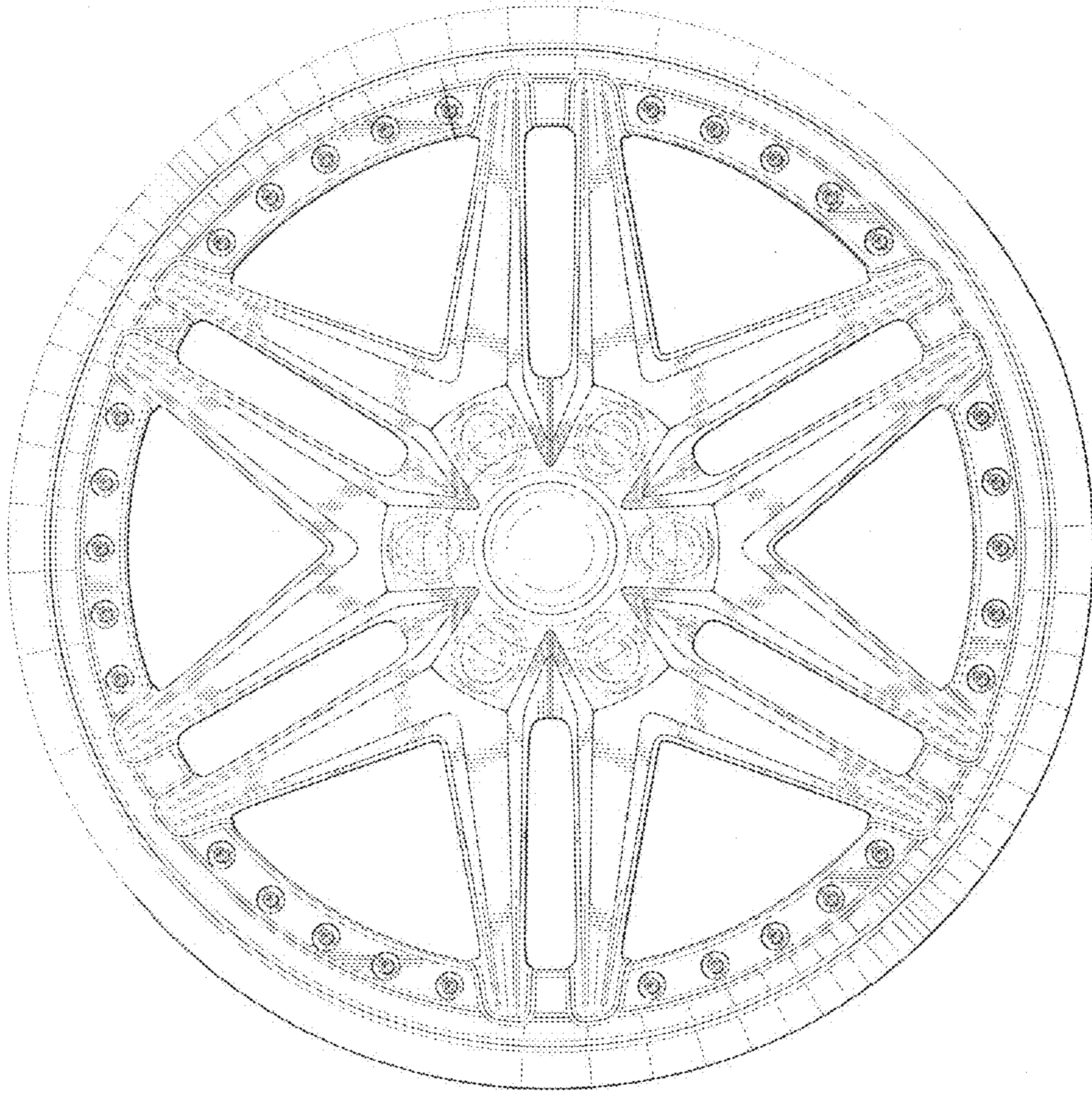

FIG. 5



*FIG. 6*

