



US00D544786S

(12) **United States Design Patent**
Barrese

(10) **Patent No.:** **US D544,786 S**

(45) **Date of Patent:** **** Jun. 19, 2007**

(54) **SHOWER CURTAIN ROD ASSEMBLY**

2005/0268394 A1* 12/2005 Monk et al 4/558

(75) Inventor: **Charles Barrese**, Huntington, NY (US)

* cited by examiner

(73) Assignee: **Ex-Cell Home Fashions, Inc.**, New York, NY (US)

Primary Examiner—T. Chase Nelson

Assistant Examiner—Barbara Blanton Lohr

(74) *Attorney, Agent, or Firm*—Robert L. Epstein; Epstein Drangel Bazerman & James

(**) Term: **14 Years**

(21) Appl. No.: **29/261,133**

(57) **CLAIM**

(22) Filed: **Jun. 8, 2006**

The ornamental design for a shower curtain rod assembly, substantially as shown and described.

(51) **LOC (8) Cl.** **08-05**

(52) **U.S. Cl.** **D8/376**

(58) **Field of Classification Search** D8/376-377;
D3/260; D6/575-581; D12/220; D13/155;
160/32, 168, 1 V; D25/119, 122; 4/506,
4/558; 52/169.5; D20/44; 16/87.4 R; 211/105.3
See application file for complete search history.

DESCRIPTION

FIG. 1 is a plan view showing the top of the preferred embodiment of my invention as it would appear mounted within a shower enclosure;

FIG. 2 is a plan view showing the bottom of the preferred embodiment of my invention;

FIG. 3 is a elevational view showing the front of the preferred embodiment of my invention;

FIG. 4 is a elevational view showing the back of the preferred embodiment of my invention;

FIG. 5 is a elevational view showing one side of the preferred embodiment of my invention, the other side being the mirror image of the side shown; and,

FIG. 6 is a partial, enlarged isometric view of the area circled and labeled 6 in the FIG. 1 view.

The broken line and dashed and dotted line borders and environmental structure shown in the FIGS. 1 and 6 views are for illustrative purposes only and form no part of the claimed design.

(56) **References Cited**

U.S. PATENT DOCUMENTS

2,778,030 A	1/1957	Goche	
3,107,361 A	10/1963	Glutting, Sr.	
3,557,390 A	1/1971	Ruggles et al.	
4,754,504 A	7/1988	Cellini	
5,103,531 A	4/1992	Perrotta	
5,513,419 A *	5/1996	Zinger	16/87.4 R
D397,928 S	9/1998	Wise	
D426,142 S	6/2000	Moore	
6,216,287 B1	4/2001	Wise	
6,263,523 B1	7/2001	Moore	
D483,251 S	12/2003	Suero, Jr.	
6,715,163 B1 *	4/2004	Cunningham	4/558
6,824,000 B2 *	11/2004	Samelson	211/105.3
D534,062 S *	12/2006	van den Bosch	D8/376

1 Claim, 2 Drawing Sheets

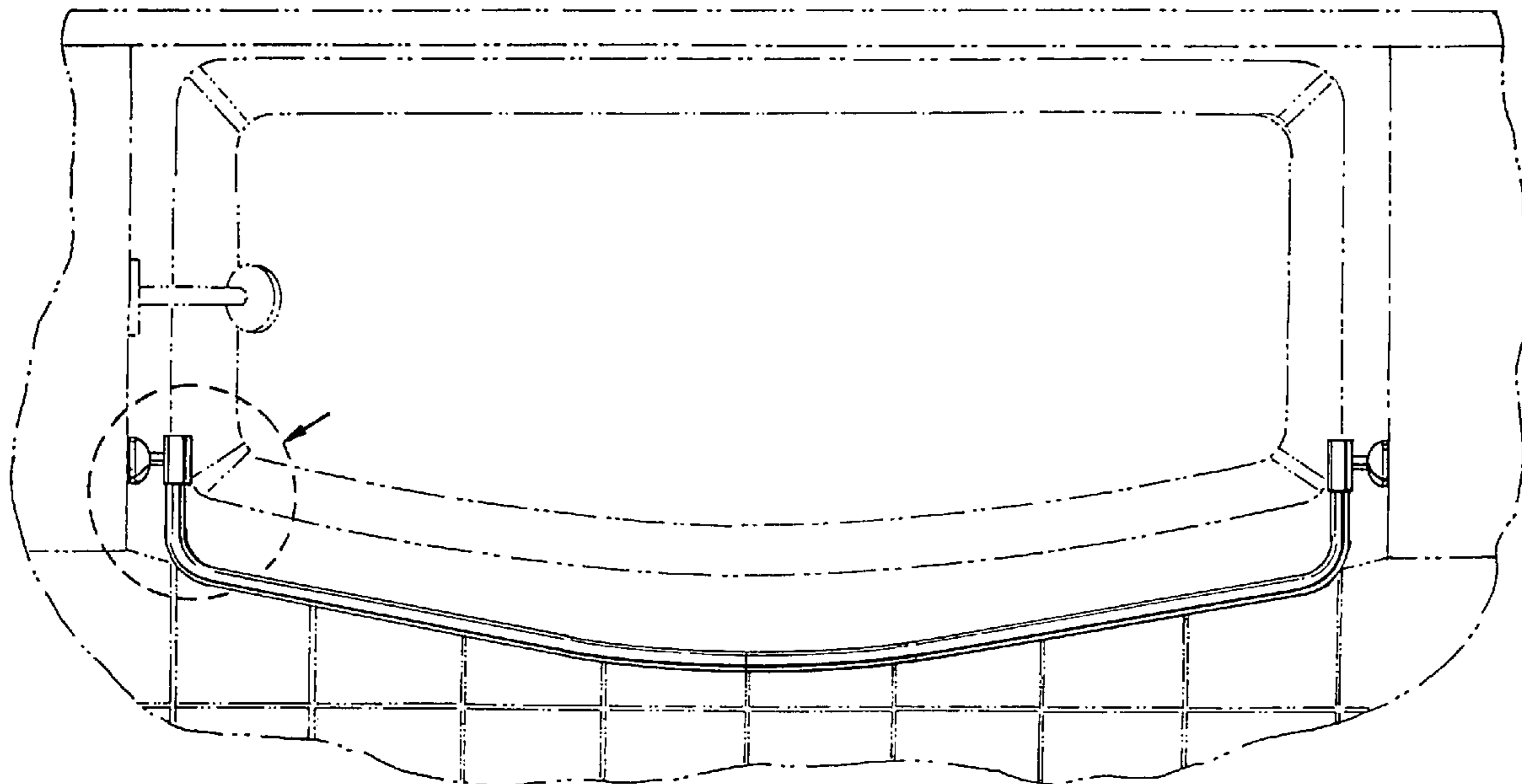

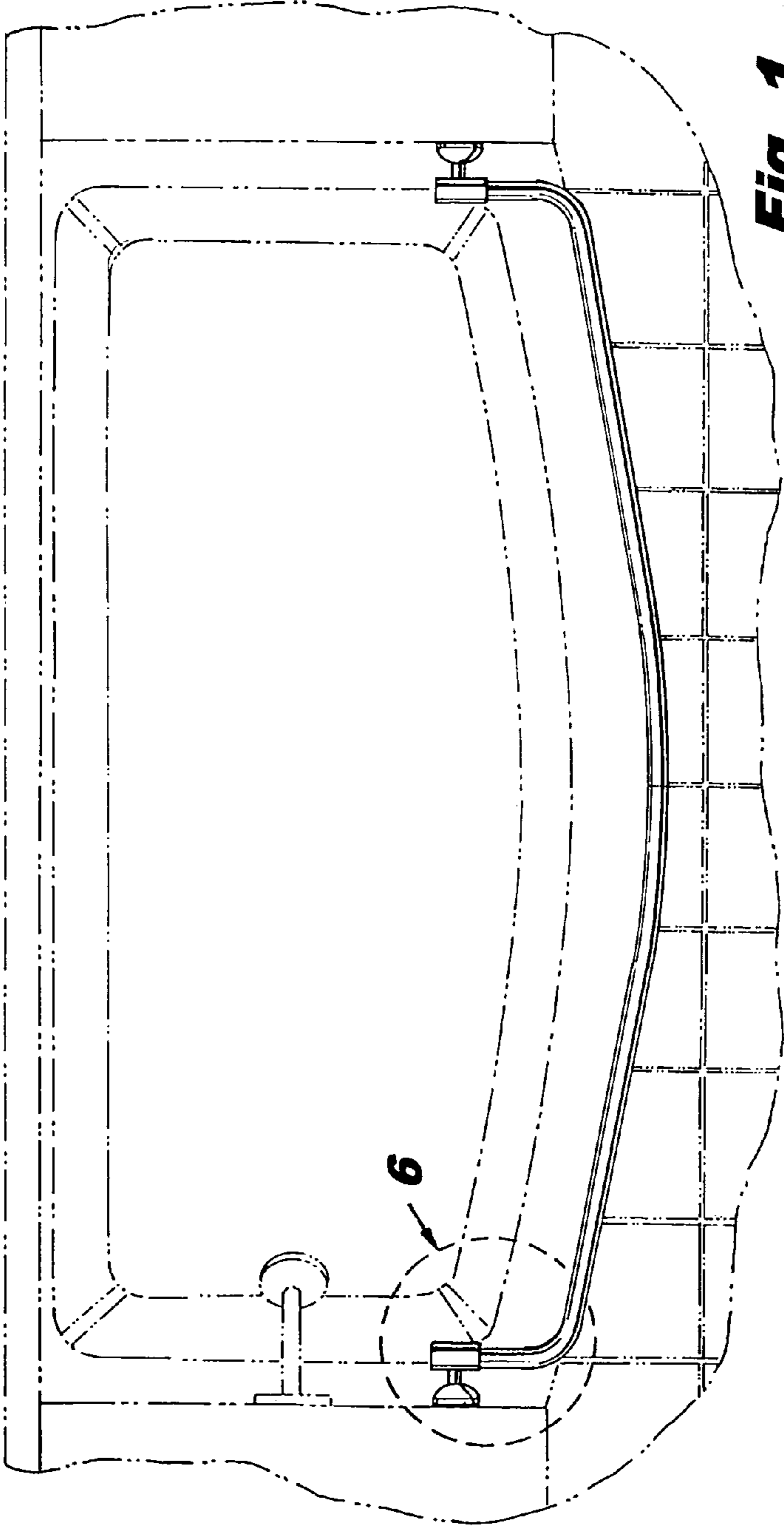

Fig. 1

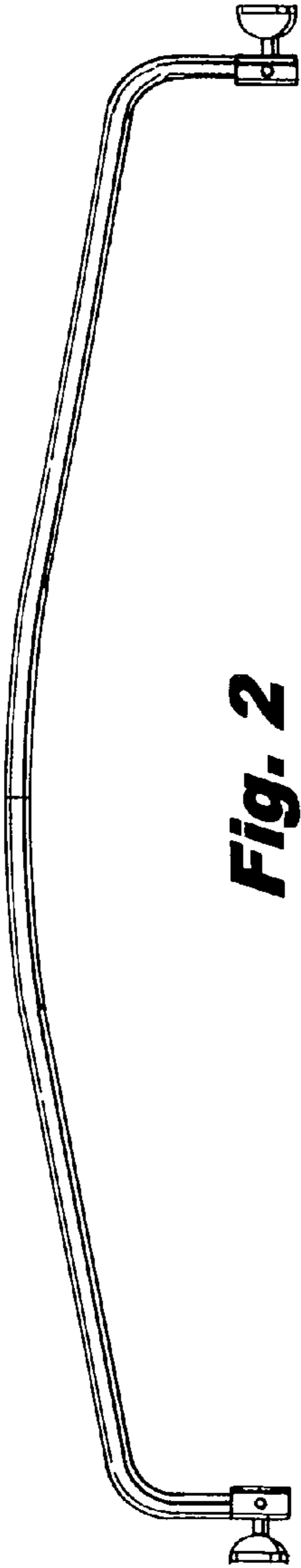

Fig. 2

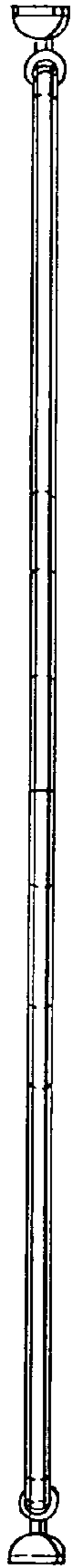

Fig. 3

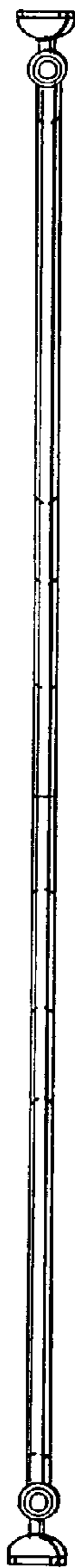

Fig. 4

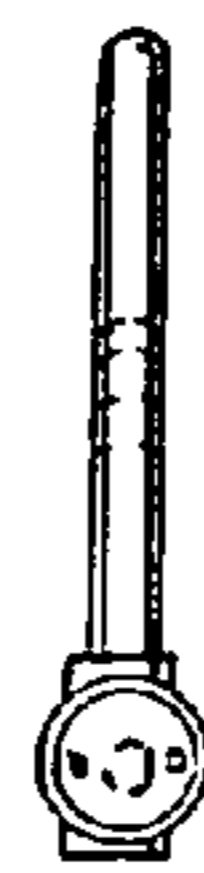

Fig. 5

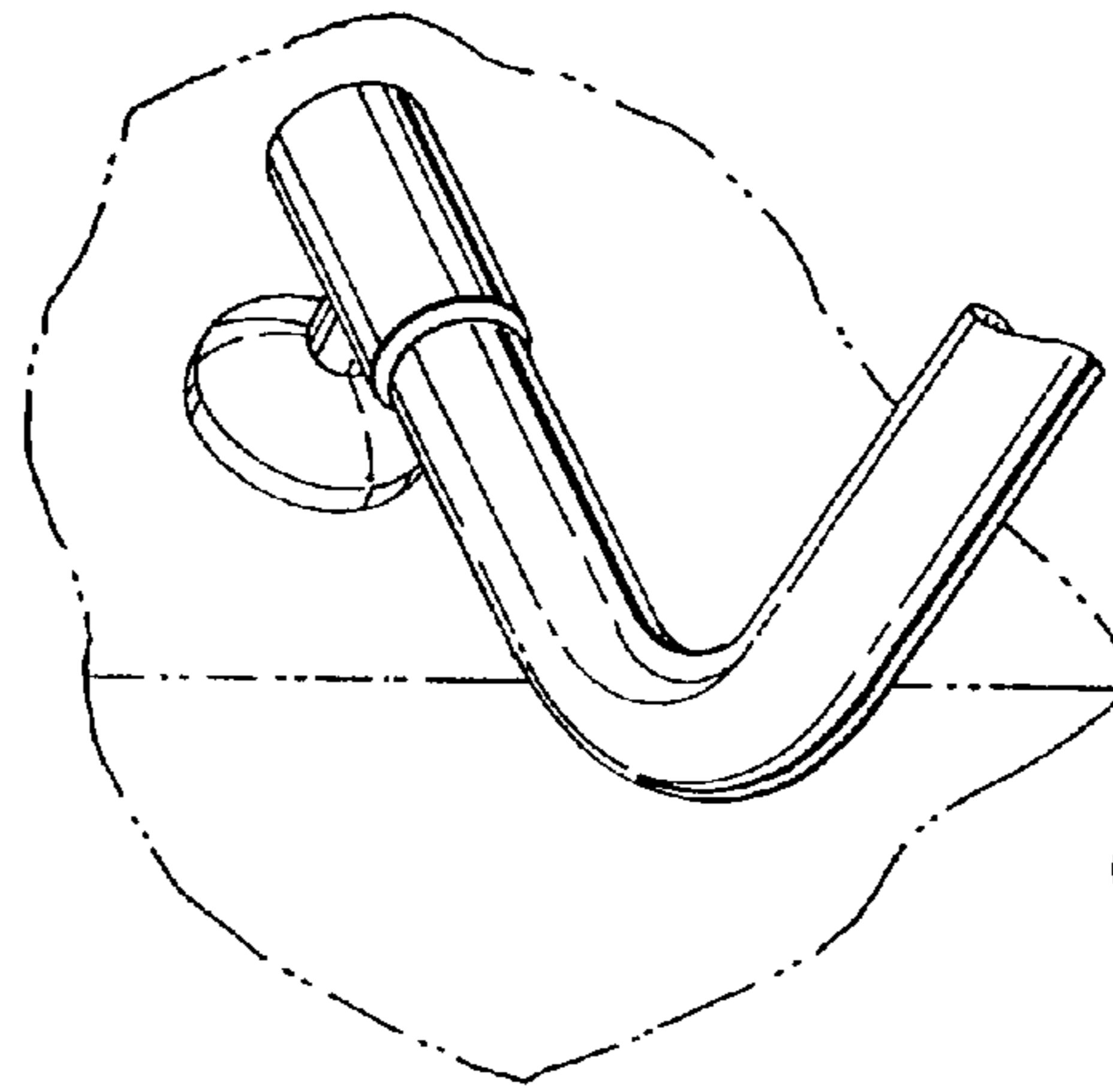

Fig. 6