

US00D544667S

(12) **United States Design Patent**
Nelson et al.

(10) **Patent No.:** **US D544,667 S**
(45) **Date of Patent:** **** Jun. 12, 2007**

(54) **FLOOR CLEANING DEVICE**

(75) Inventors: **Mark W. Nelson**, Lino Lakes, MN (US); **Michael J. Kubes**, Oakdale, MN (US); **Perry S. Dotterman**, Maplewood, MN (US); **Byron E. Trotter**, St. Paul, MN (US); **Arthur V. Lang**, Maplewood, MN (US)

(73) Assignee: **3M Innovative Properties Company**, St. Paul, MN (US)

(**) Term: **14 Years**

(21) Appl. No.: **29/222,359**

(22) Filed: **Jan. 28, 2005**

(51) **LOC (8) Cl.** **04-01**

(52) **U.S. Cl.** **D32/50**

(58) **Field of Classification Search** D32/40,
D32/50, 51; D4/199; 15/147.1, 147.2, 209.1,
15/210.1, 220.1, 228, 229.3, 229.4, 229.7,
15/229.8, 244.1, 244.2

See application file for complete search history.

(56) **References Cited**

U.S. PATENT DOCUMENTS

- 1,186,960 A 6/1916 Wells
- 2,214,519 A * 9/1940 Bailey 15/147.2 X
- D152,843 S 2/1949 Wagner
- D185,727 S 7/1959 Yamen
- 3,319,278 A * 5/1967 Frazer 15/41.1
- 5,347,679 A 9/1994 Saunders et al.
- 5,470,272 A 11/1995 Kikuchi et al.

- 5,596,787 A 1/1997 Stevens et al.
- 5,862,565 A 1/1999 Lundstedt
- 6,895,626 B2 5/2005 Tsai

* cited by examiner

Primary Examiner—Alan P. Douglas
Assistant Examiner—Lavone D. Tabor
(74) *Attorney, Agent, or Firm*—Trisha D. Adamson

(57) **CLAIM**

The ornamental design for a floor cleaning device, as shown and described.

DESCRIPTION

FIG. 1 is a perspective view of a floor cleaning device showing the new design;

FIG. 2 is a left side view thereof, the right side view thereof being a mirror image of the left side view shown view thereof;

FIG. 3 is a top view thereof;

FIG. 4 is a bottom view thereof;

FIG. 5 is a front view thereof; and,

FIG. 6 is a rear view thereof.

The broken line showing of the circular area on the top surface of the head, a connector, and handle is included for the purpose of illustrating portions of the article that form no part of the claimed design. The surface shading illustrated in the drawings is provided merely to highlight the contour of the design and is not intended to be illustrative texture or gloss.

1 Claim, 4 Drawing Sheets

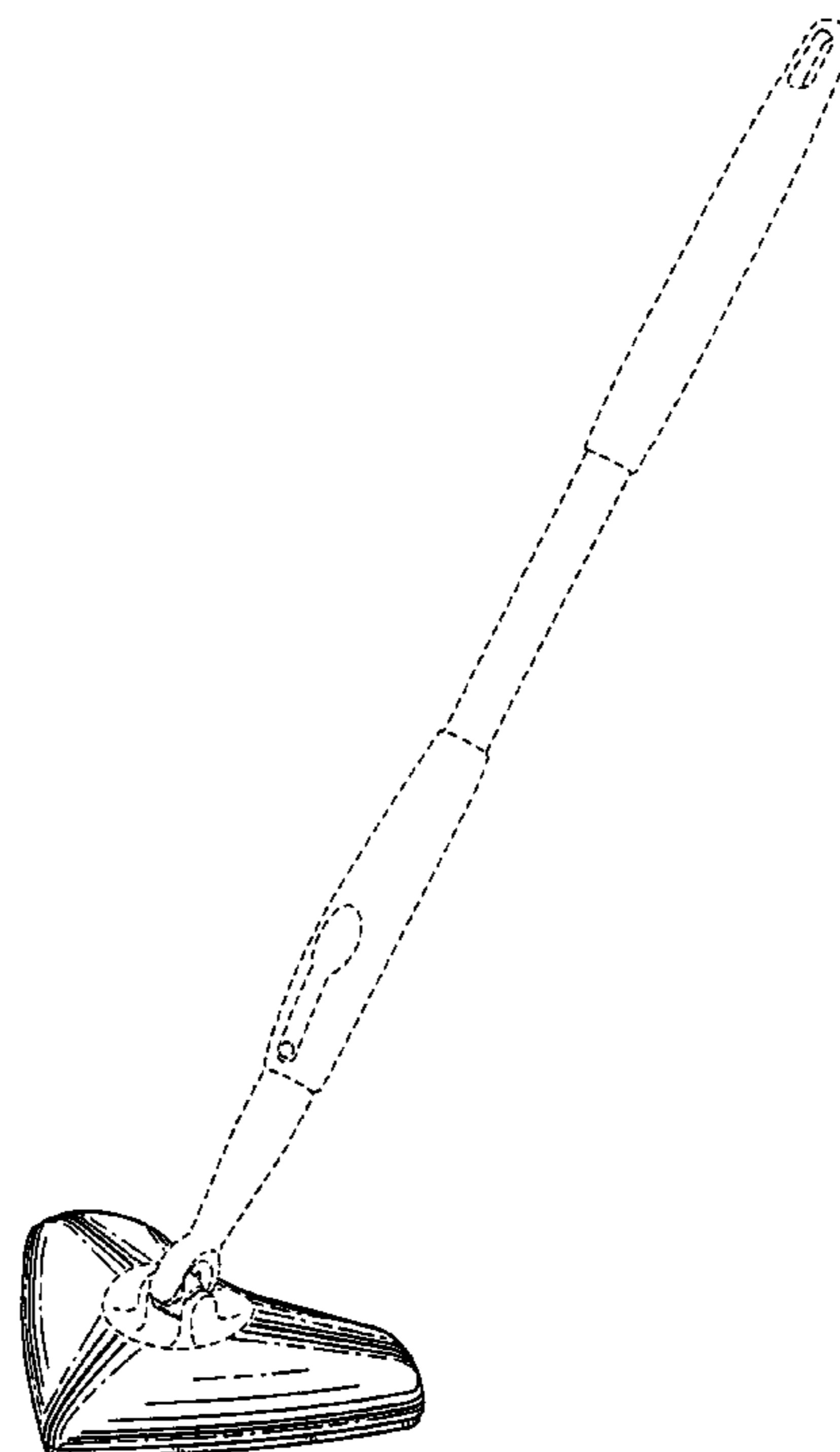

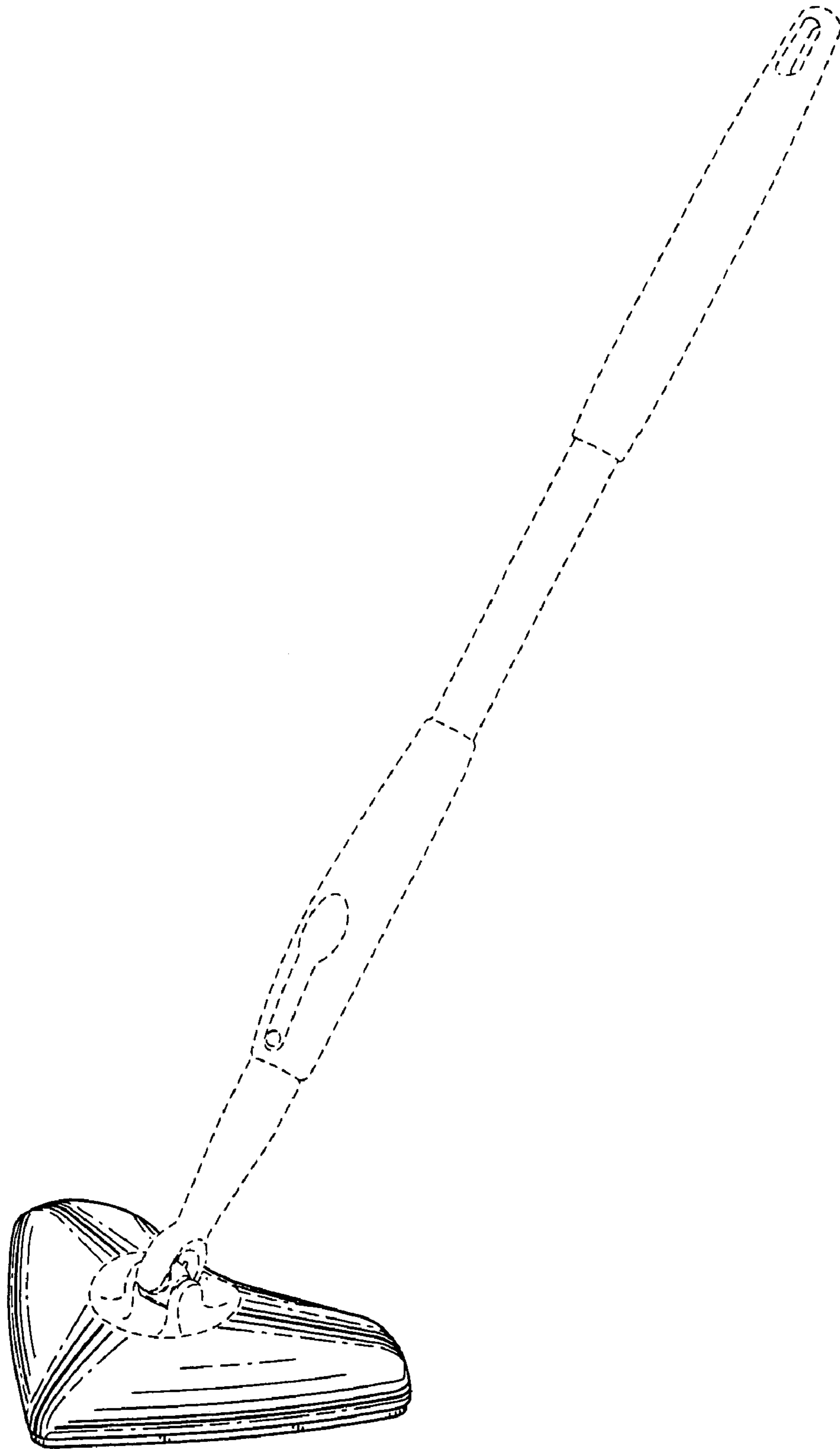

FIG. 1

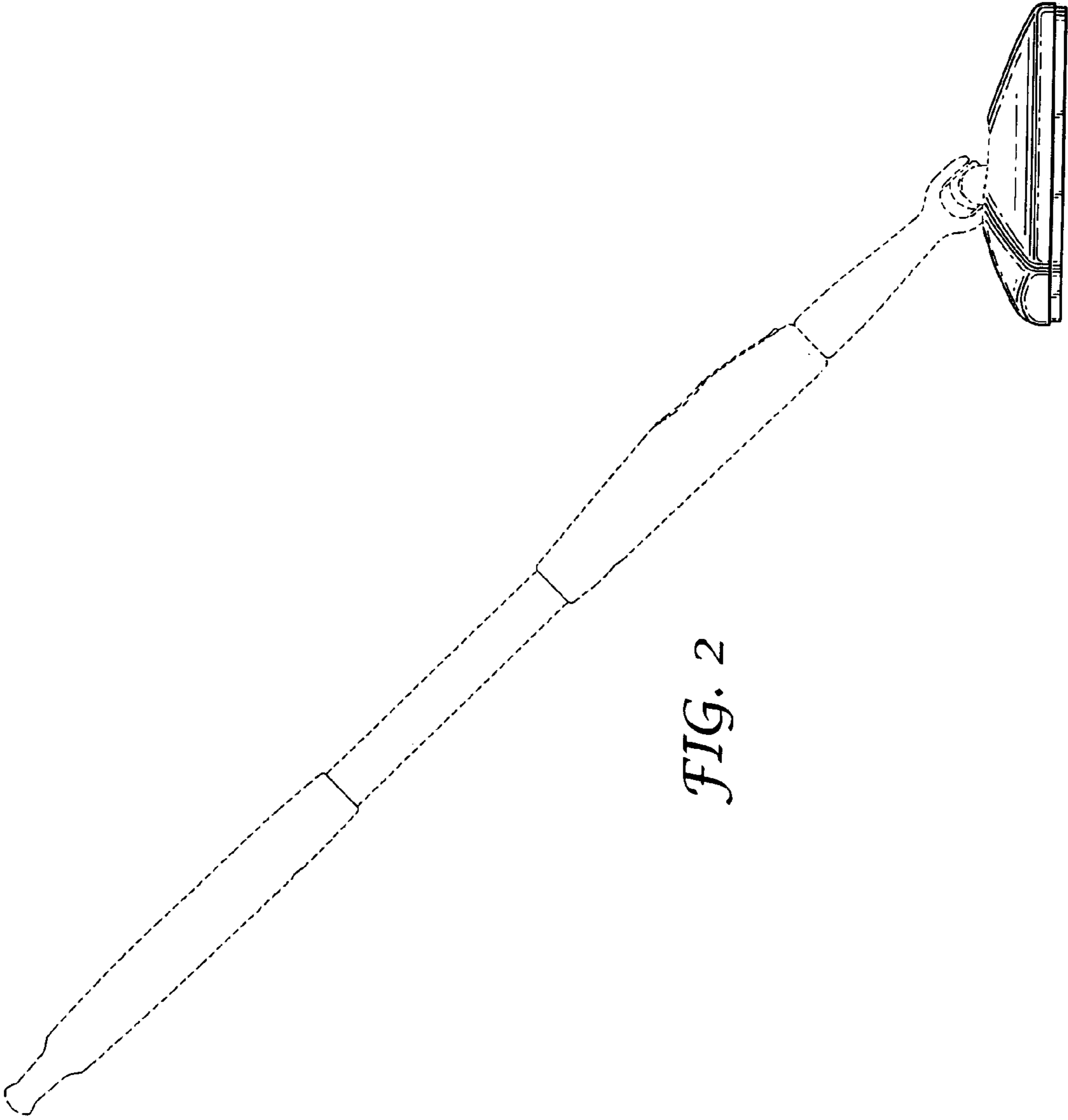

FIG. 2

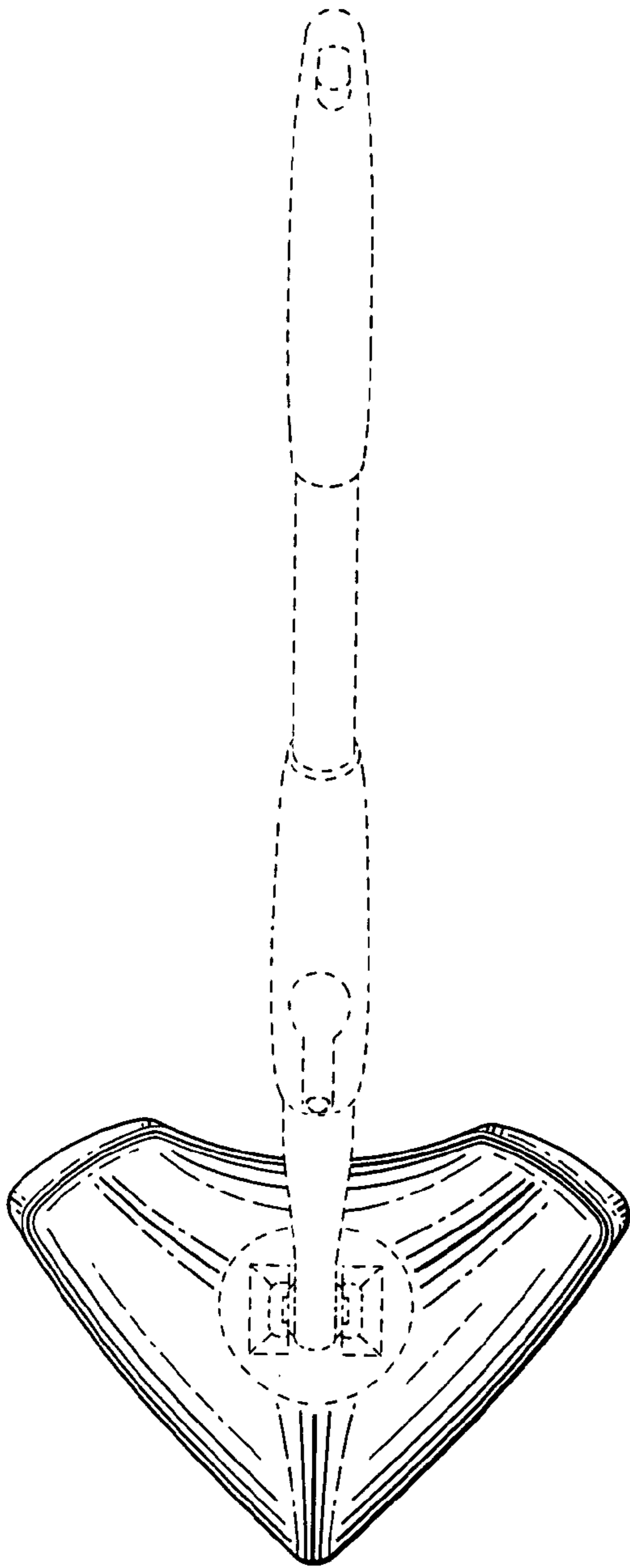

FIG. 3

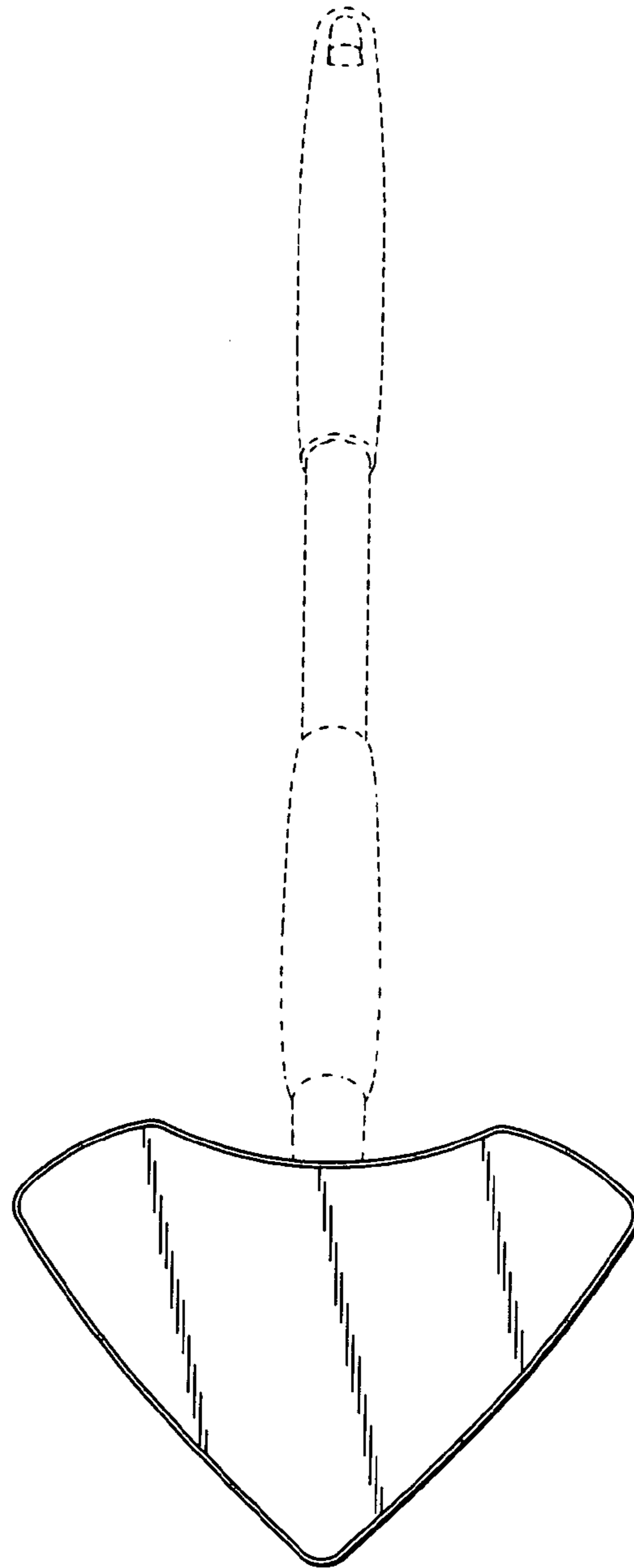

FIG. 4

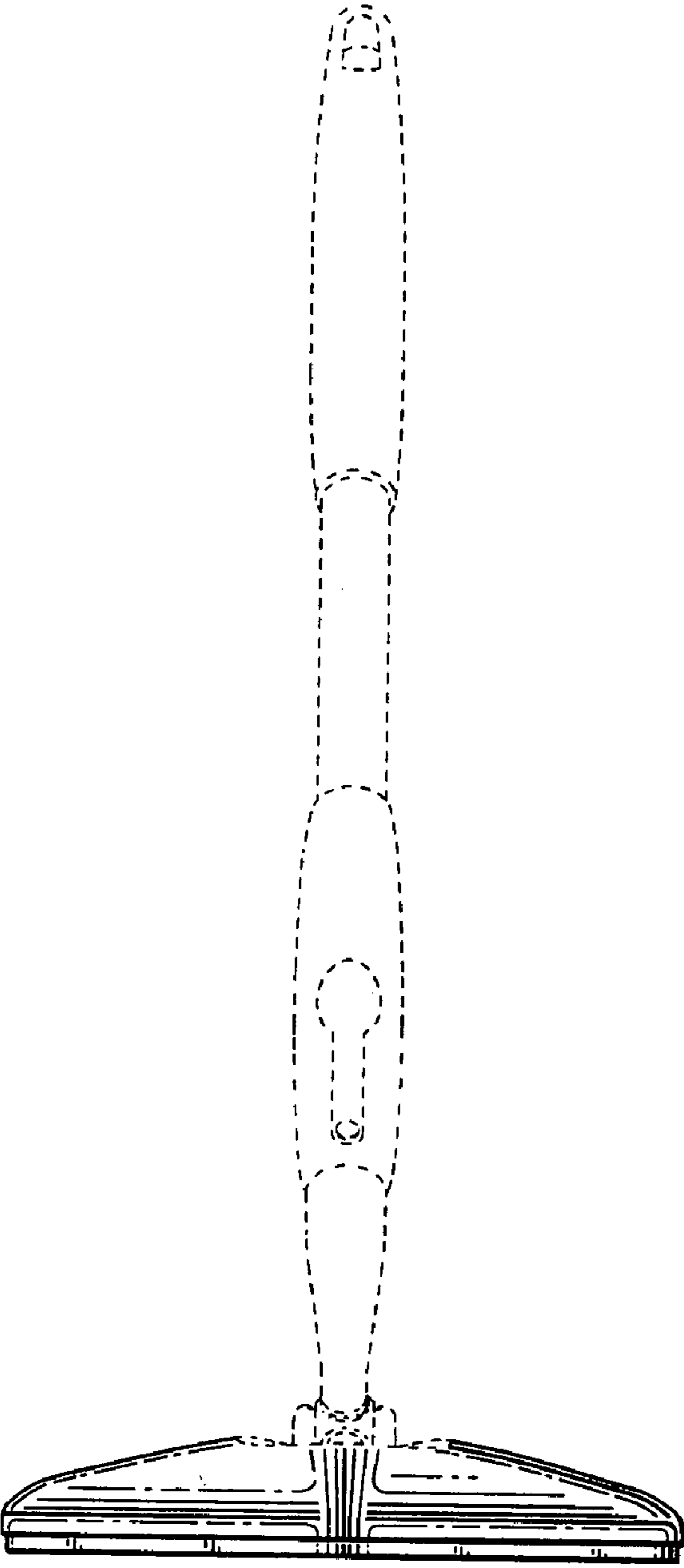

FIG. 5

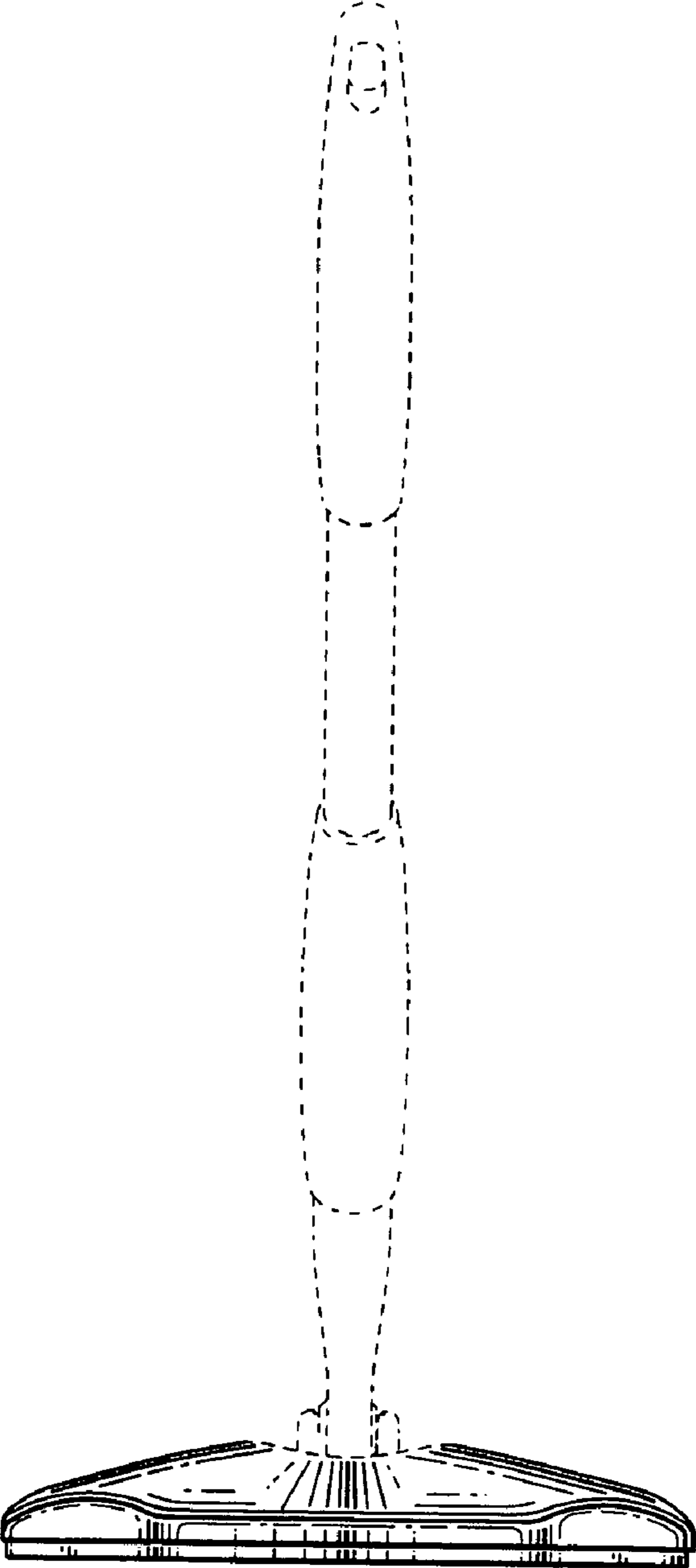

FIG. 6