



US00D544643S

(12) **United States Design Patent**  
**Lin**

(10) **Patent No.:** **US D544,643 S**  
(45) **Date of Patent:** **\*\* Jun. 12, 2007**

(54) **CIGARETTE-MAKING MACHINE**

(75) Inventor: **Mei Lin**, Glenview, IL (US)

(73) Assignee: **Republic Tobacco L.P.**, Glenview, IL (US)

(\*\*) Term: **14 Years**

(21) Appl. No.: **29/250,967**

(22) Filed: **Dec. 7, 2006**

(51) **LOC (8) Cl.** ..... **27-06**

(52) **U.S. Cl.** ..... **D27/194**

(58) **Field of Classification Search** ..... D27/172,  
D27/183, 184, 194; 131/58, 70-75

See application file for complete search history.

(56) **References Cited**

**U.S. PATENT DOCUMENTS**

2,699,787	A *	1/1955	Kastner	.....	131/70
D250,965	S *	1/1979	Moscovitch	.....	D27/194
4,249,546	A *	2/1981	Heil et al.	.....	131/70
5,088,506	A *	2/1992	Kastner	.....	131/70

\* cited by examiner

*Primary Examiner*—Jennifer Rivard

(74) *Attorney, Agent, or Firm*—Drinker Biddle & Reath LLP

(57) **CLAIM**

The ornamental design for a cigarette-making machine, as shown and described.

**DESCRIPTION**

FIG. 1 is a front perspective view of the cigarette making machine;

FIG. 2 is a rear perspective view of the cigarette making machine of FIG. 1;

FIG. 3 is a front elevation view of the cigarette making machine of FIG. 1;

FIG. 4 is a rear elevation view of the cigarette making machine of FIG. 1;

FIG. 5 is a right side elevation view of the cigarette making machine of FIG. 1;

FIG. 6 is a left side elevation view of the cigarette making machine of FIG. 1;

FIG. 7 is a top plan view of the cigarette making machine of FIG. 1; and,

FIG. 8 is a bottom plan view of the cigarette making machine of FIG. 1, wherein the broken lines show environmental structure for illustrative purposes only and form no part of the claimed design or a specified embodiment thereof.

**1 Claim, 7 Drawing Sheets**

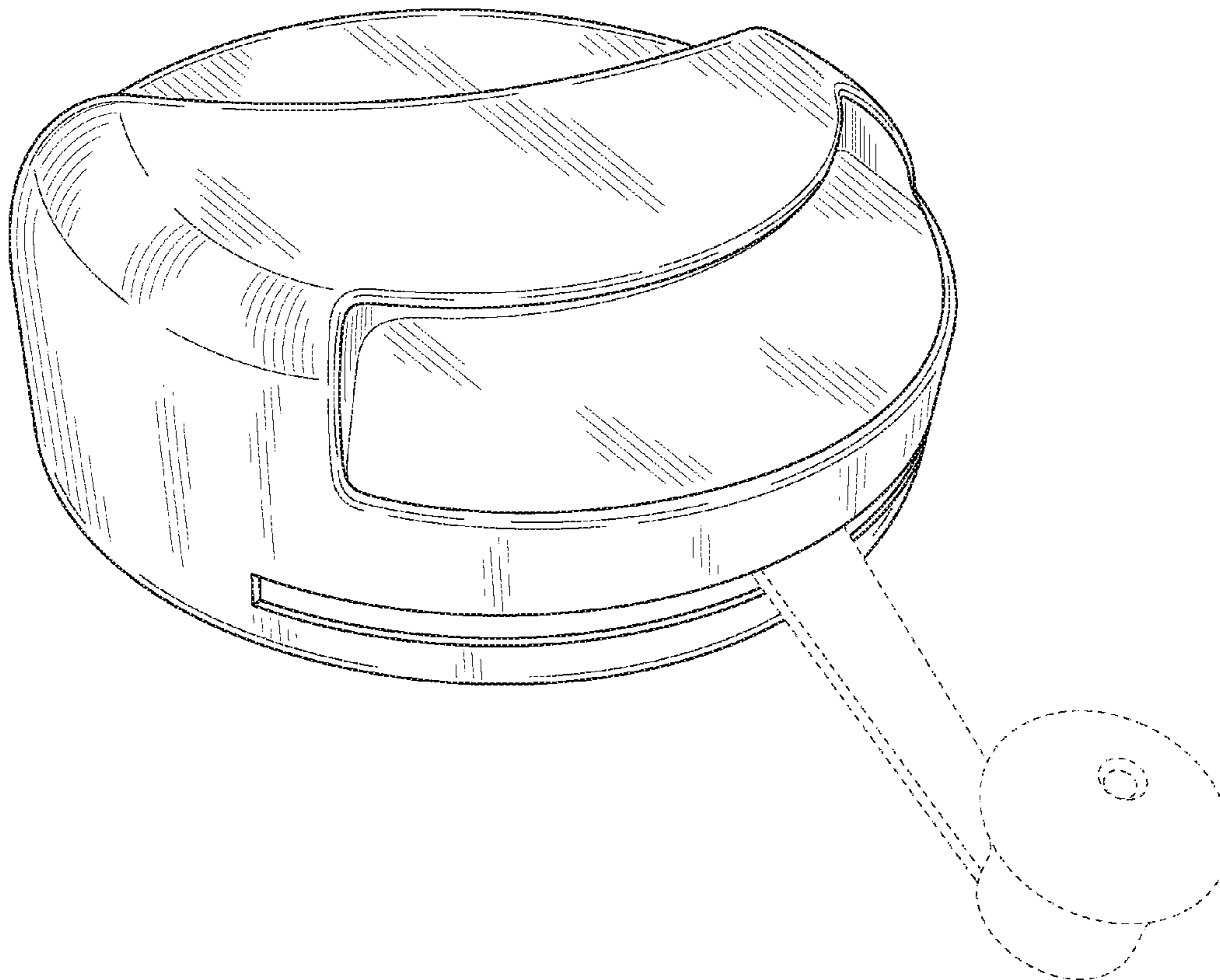

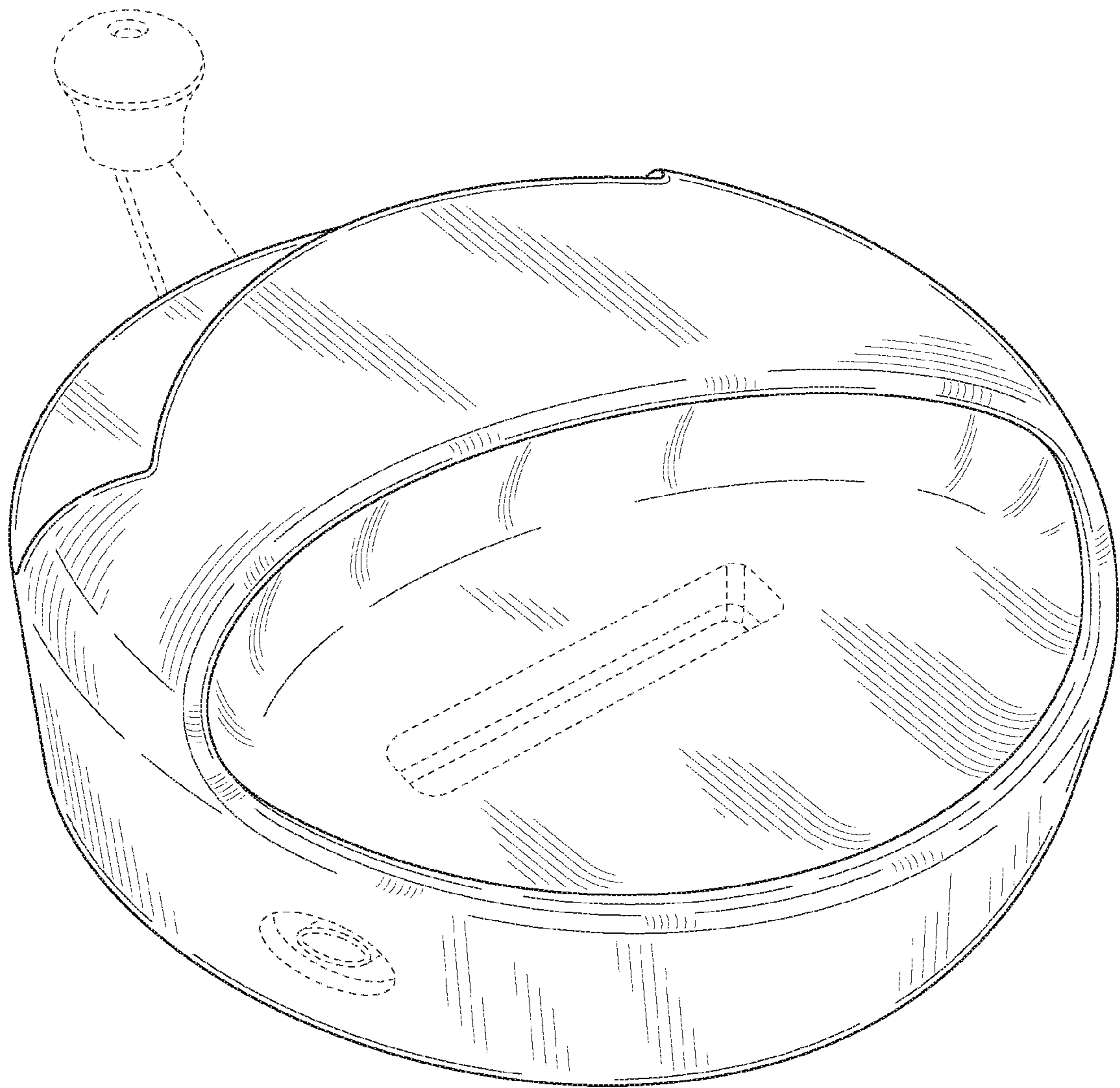

FIG. 1

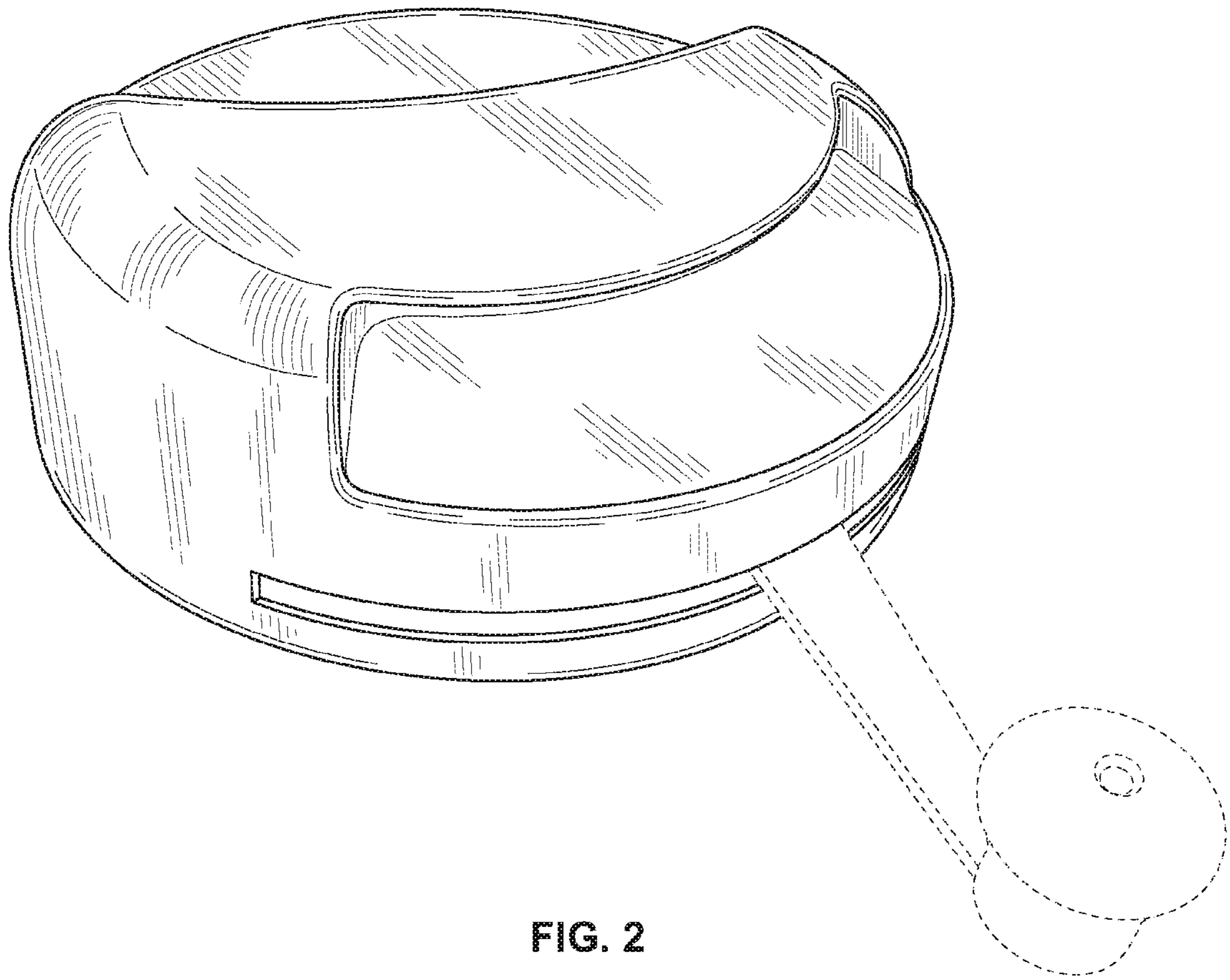

FIG. 2

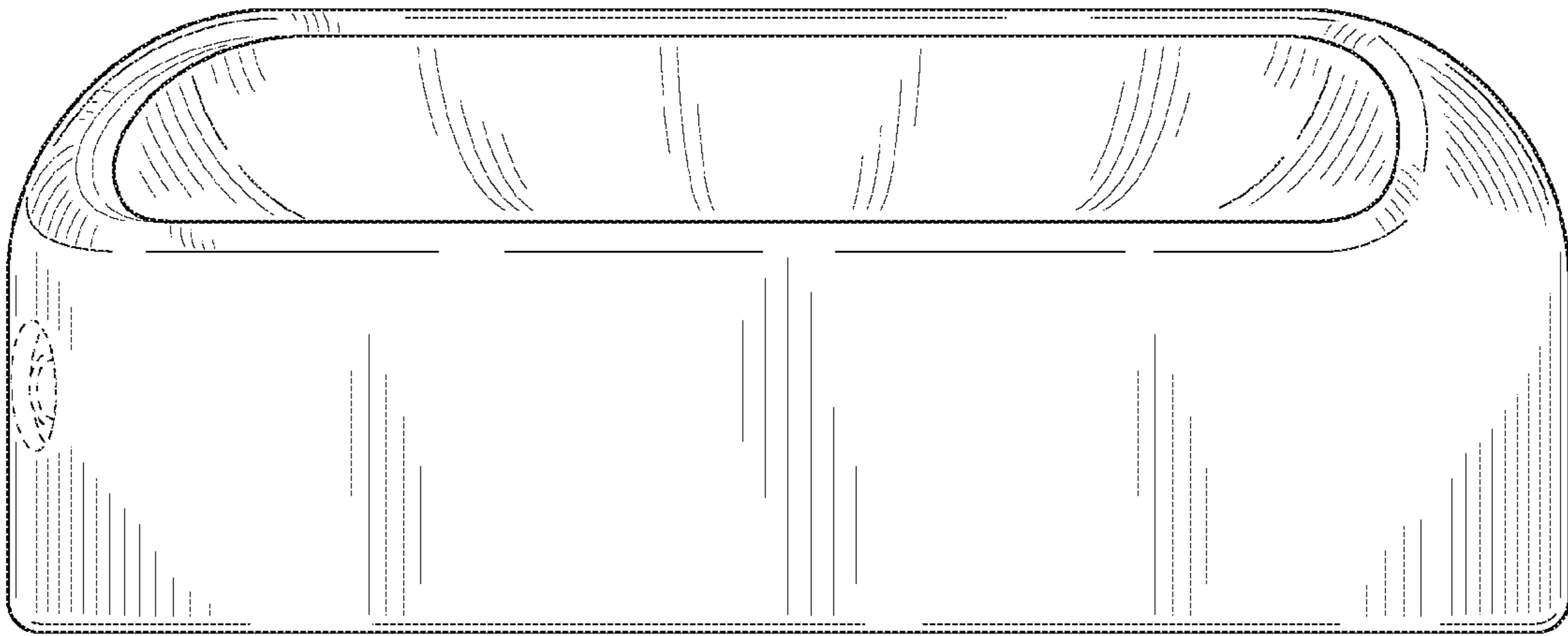

FIG. 3

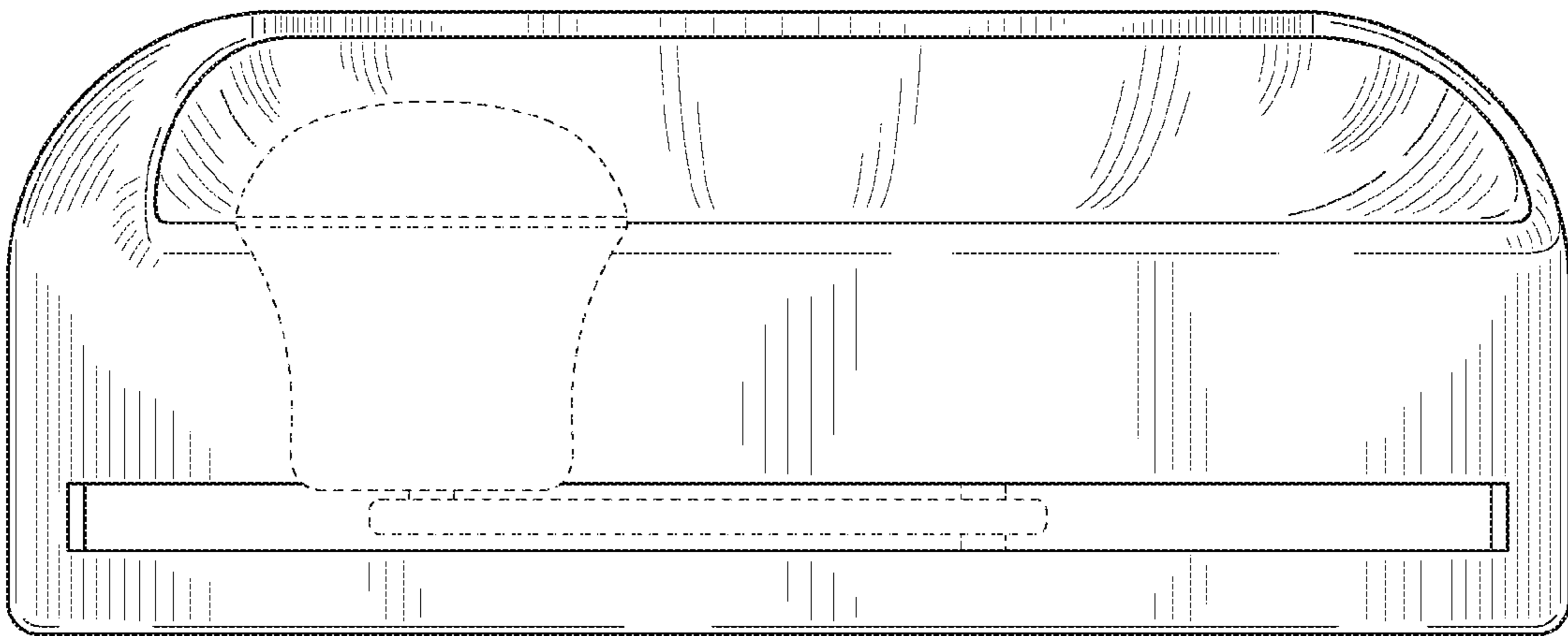

FIG. 4

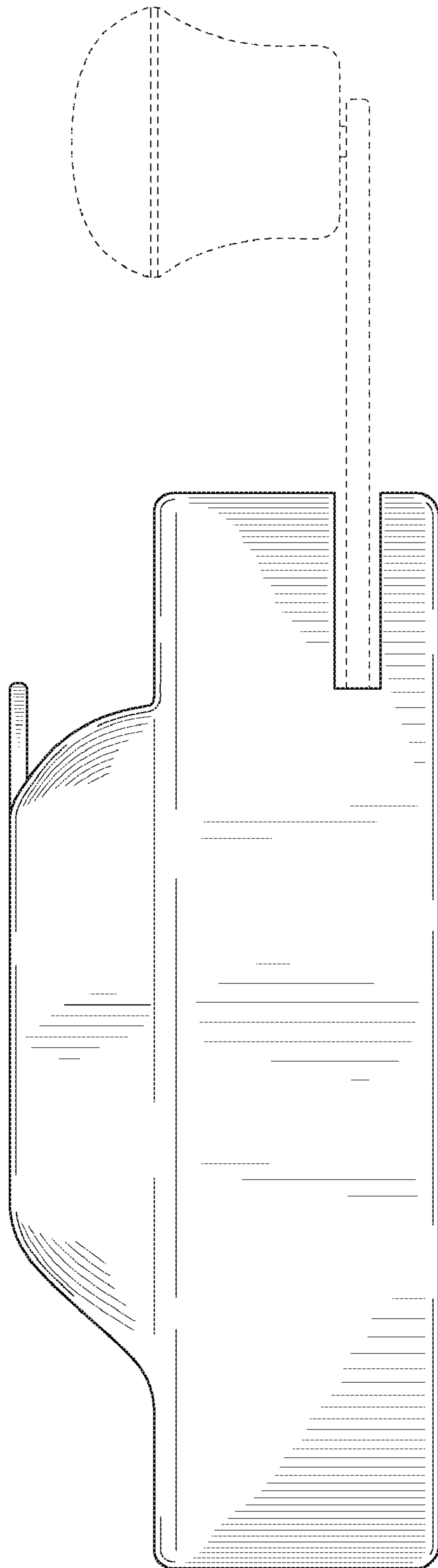

FIG. 5

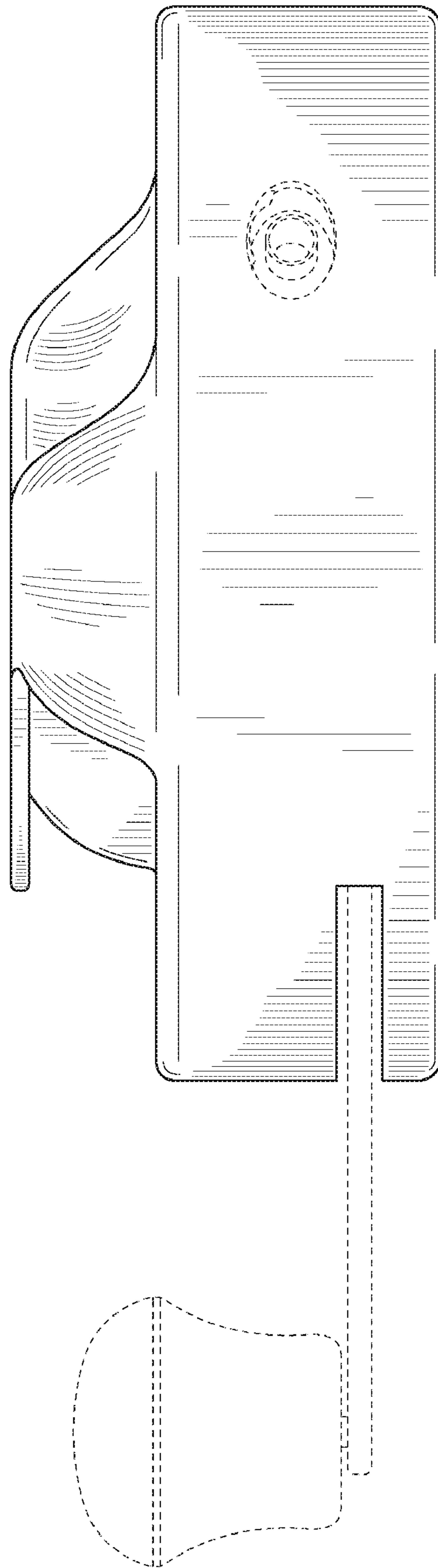

FIG. 6

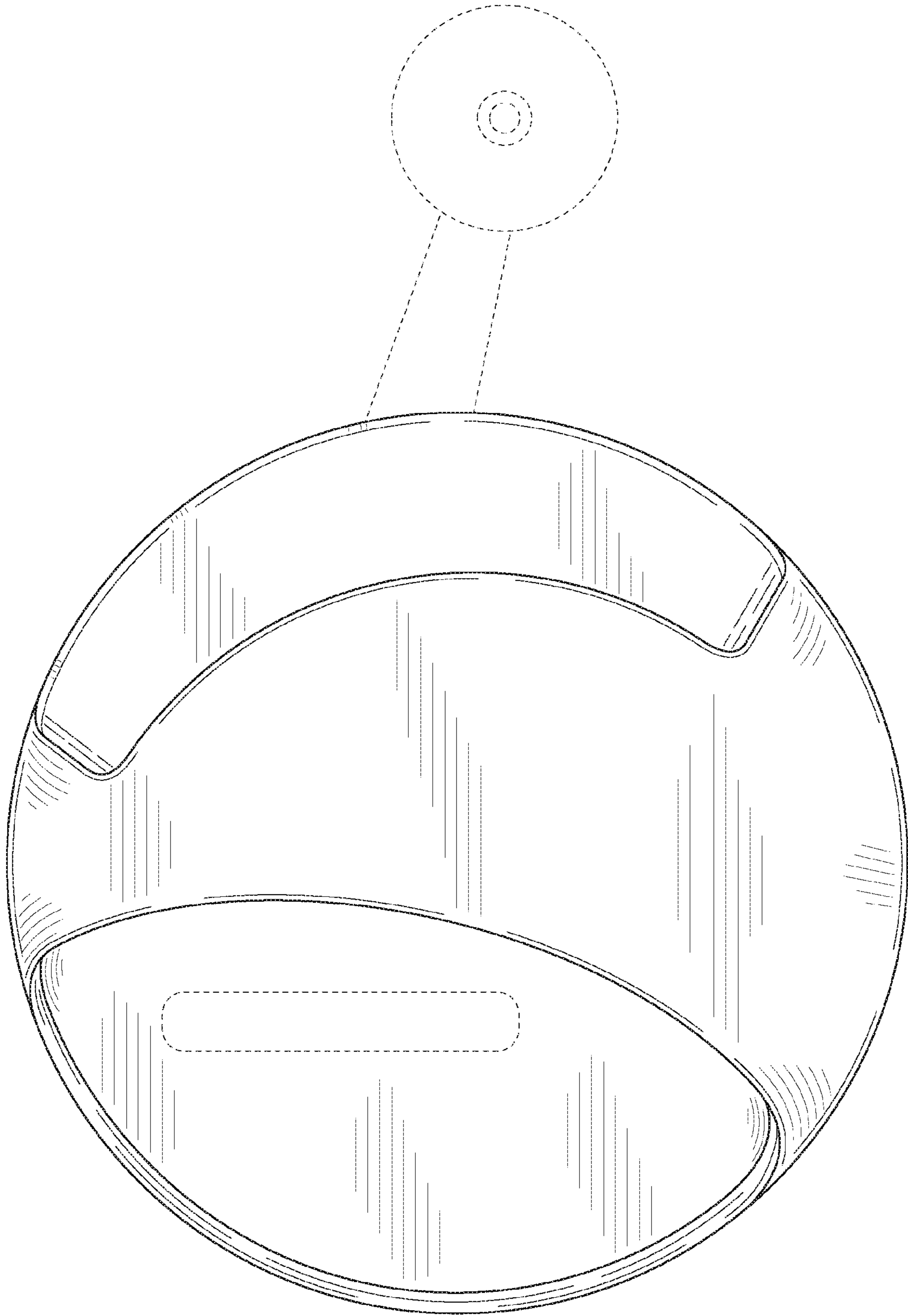

FIG. 7

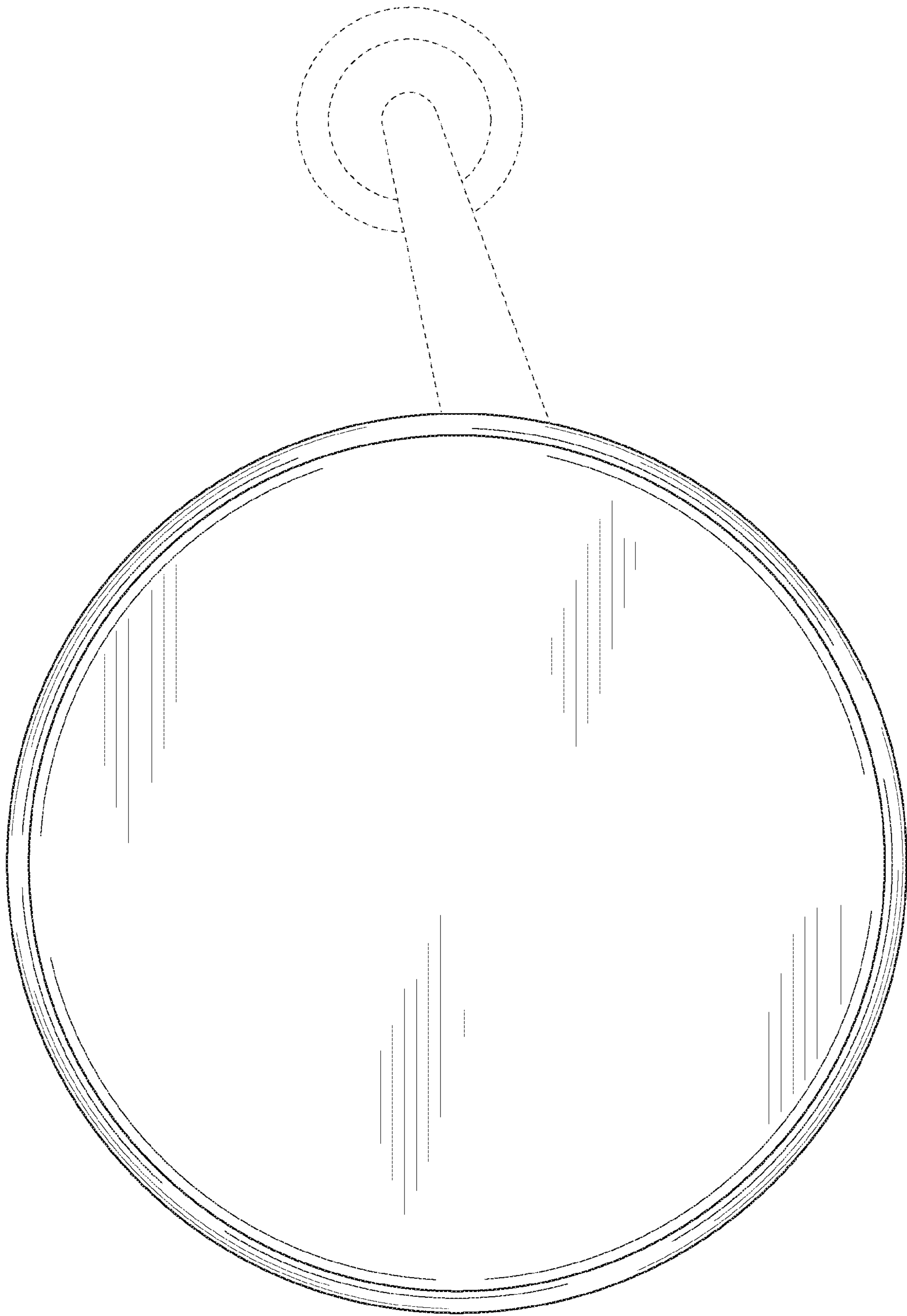

FIG. 8