

US00D544623S

(12) **United States Design Patent**
Pickett

(10) **Patent No.:** **US D544,623 S**

(45) **Date of Patent:** **** Jun. 12, 2007**

(54) **COMBINED CEILING FAN HOUSING AND LIGHT KIT**

(76) Inventor: **Mark Pickett**, 1419 E. Palm St., Altadena, CA (US) 91001

(**) Term: **14 Years**

(21) Appl. No.: **29/226,954**

(22) Filed: **Apr. 5, 2005**

(51) **LOC (8) Cl.** **26-05**

(52) **U.S. Cl.** **D26/59; D26/89**

(58) **Field of Classification Search** D26/59,
D26/72, 84, 85, 88, 89, 128, 130-136; D23/377,
D23/379, 411; 416/5; 362/96, 147, 312,
362/404-408

See application file for complete search history.

(56) **References Cited**

U.S. PATENT DOCUMENTS

D40,180 S *	7/1909	Mygatt	D26/134
D60,716 S *	3/1922	Ainsworth	D26/88
D63,700 S *	1/1924	Silverman	D26/88
D67,935 S *	8/1925	Ullman	D26/89
1,735,997 A *	11/1929	Doane	D26/88

D119,789 S *	4/1940	McFadden	D26/88
D435,901 S *	1/2001	Tsuji	D23/411
D525,696 S *	7/2006	Ertze	D23/377
D527,451 S *	8/2006	Glasbrenner	D23/377

* cited by examiner

Primary Examiner—Clare E Heflin

(74) *Attorney, Agent, or Firm*—Parsons & Goltry; Michael W. Goltry; Robert A. Parsons

(57) **CLAIM**

The ornamental design for a combined ceiling fan housing and light kit, as shown and described.

DESCRIPTION

FIG. 1 is a bottom perspective view of a combined ceiling fan housing and light kit showing my new design;

FIG. 2 is a top perspective view thereof;

FIG. 3 is a front elevational view thereof, the rear elevational view, the left side elevational view, and the right side elevational view being substantially the same thereof;

FIG. 4 is a top plan view thereof; and,

FIG. 5 is a bottom plan view thereof.

1 Claim, 5 Drawing Sheets

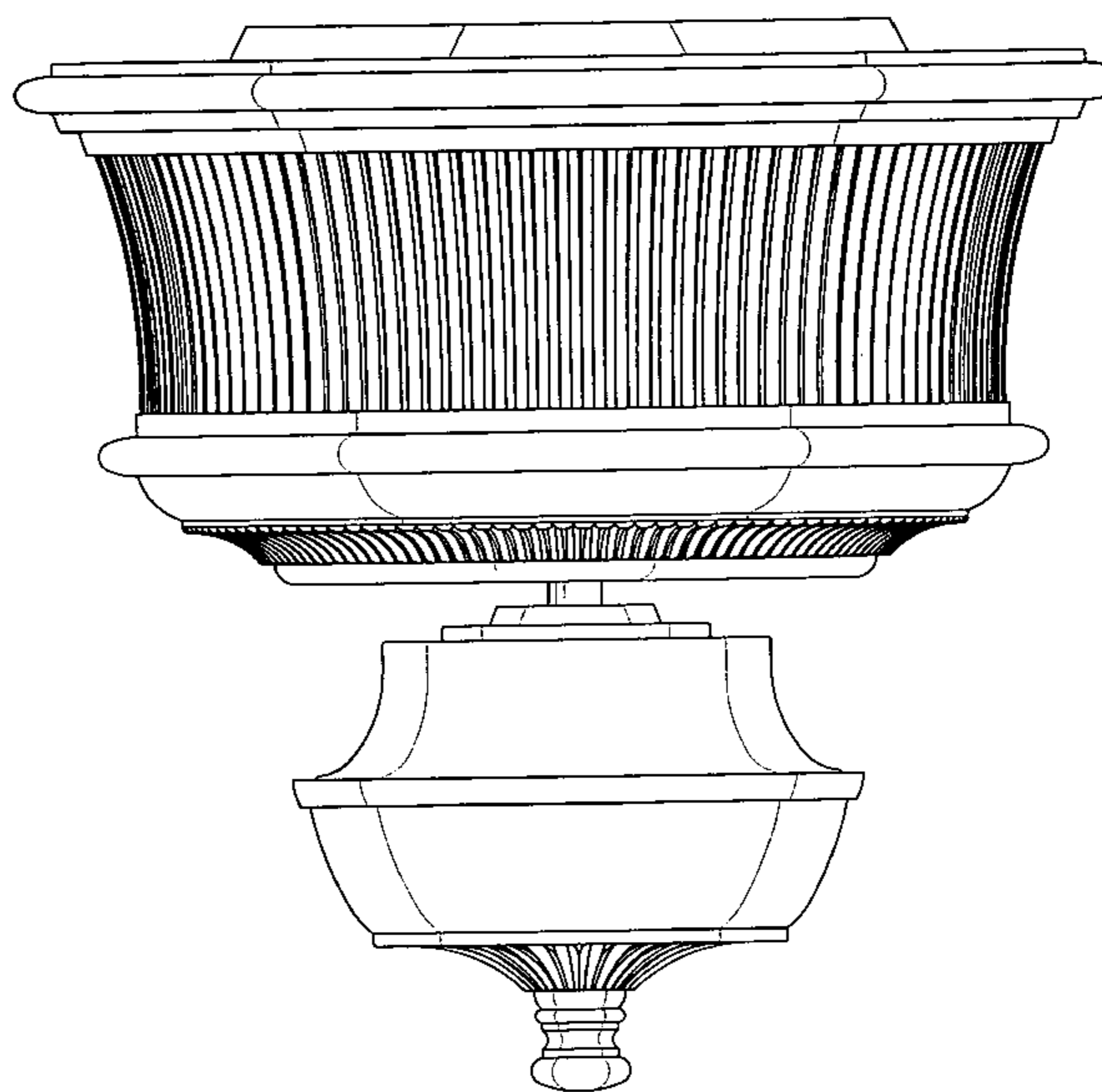
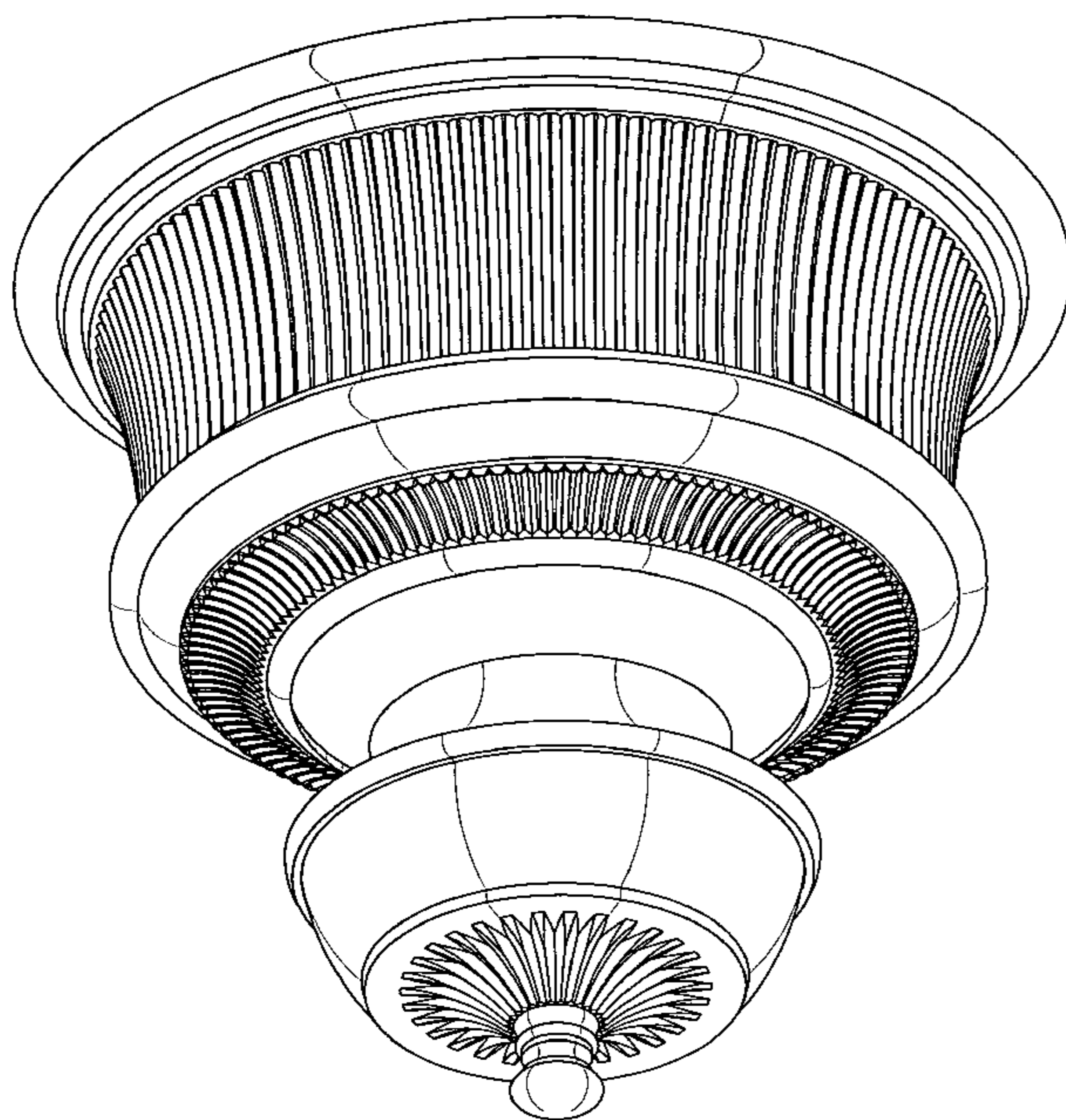

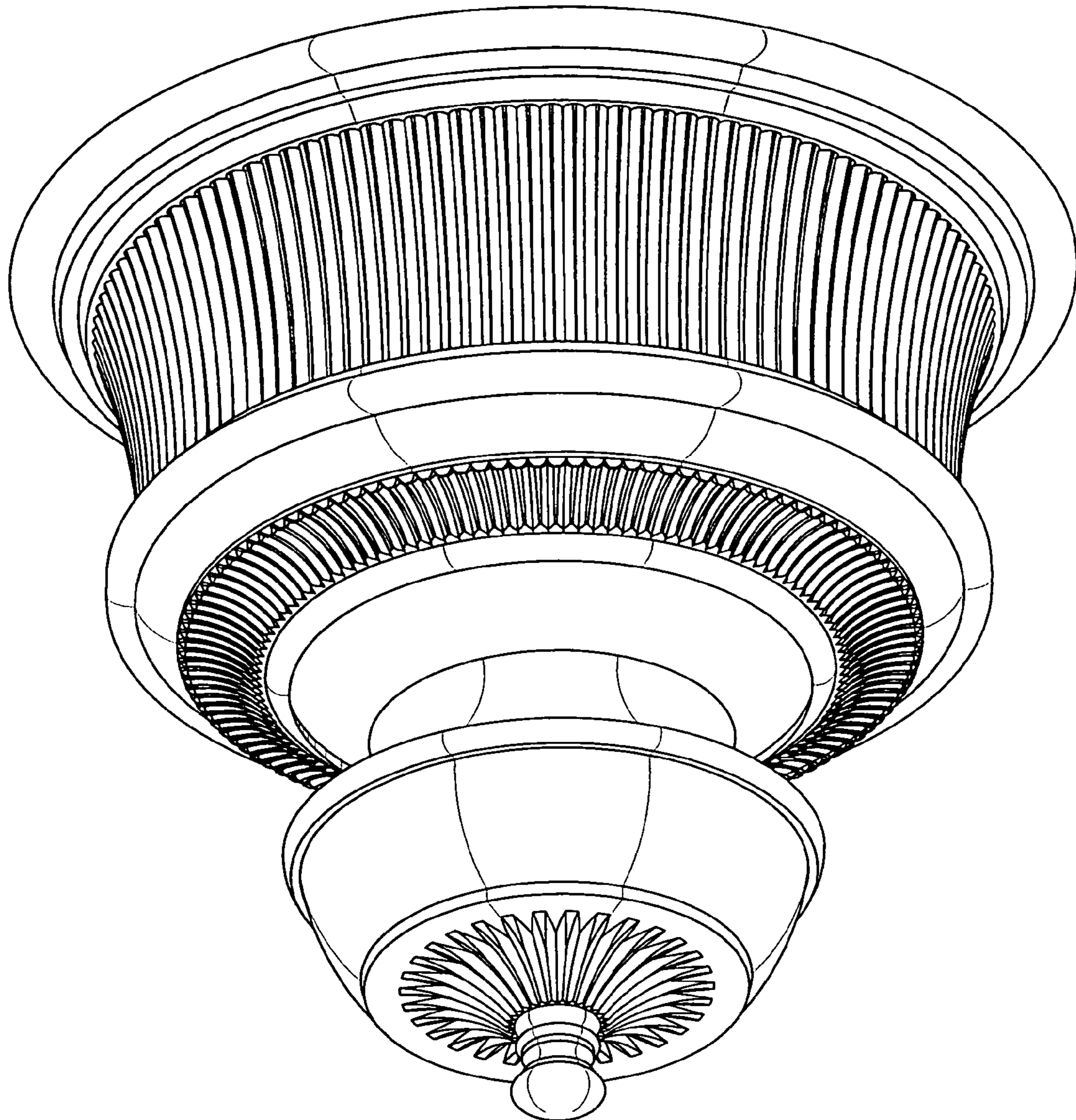

FIG. 1

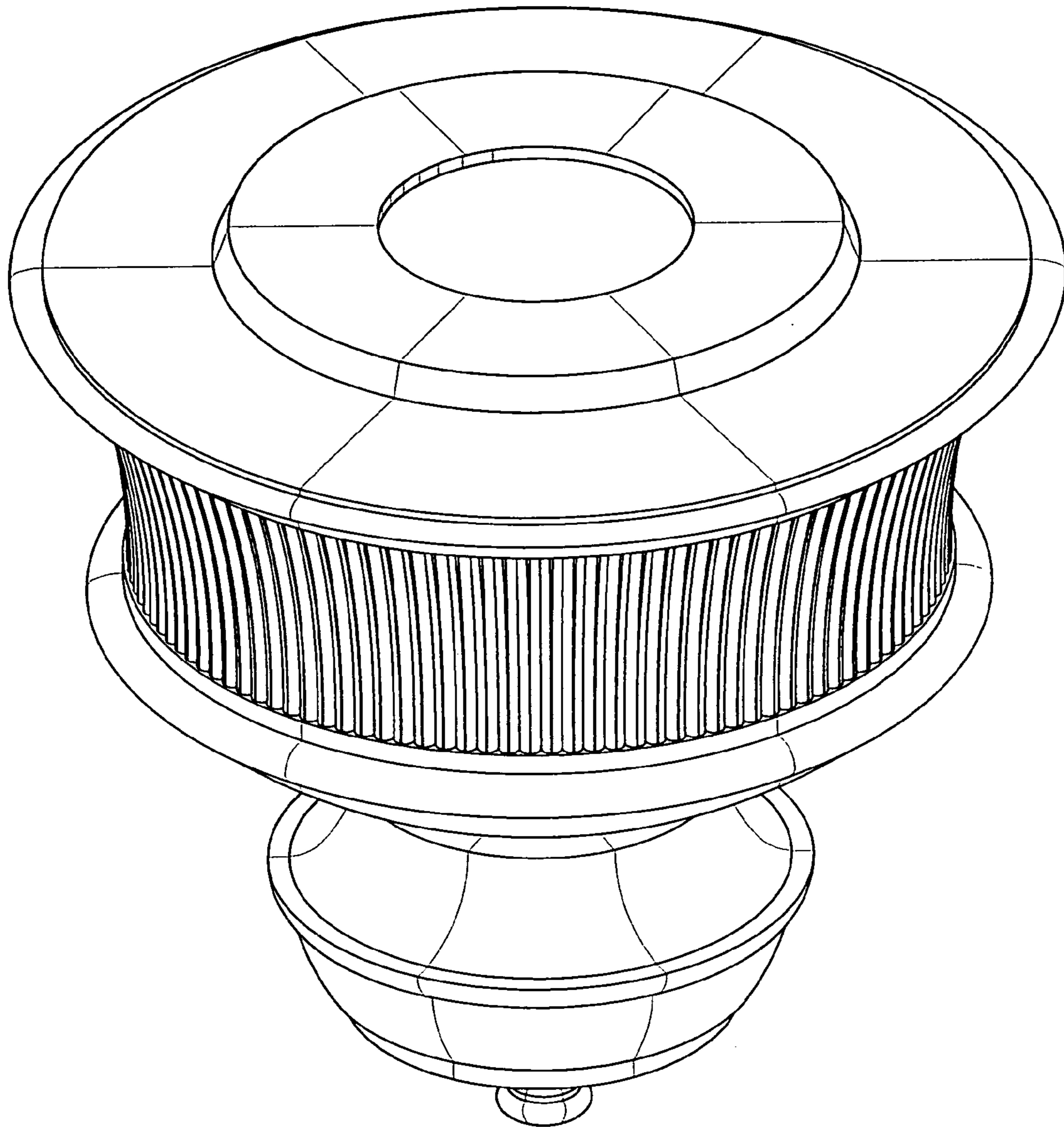

FIG. 2

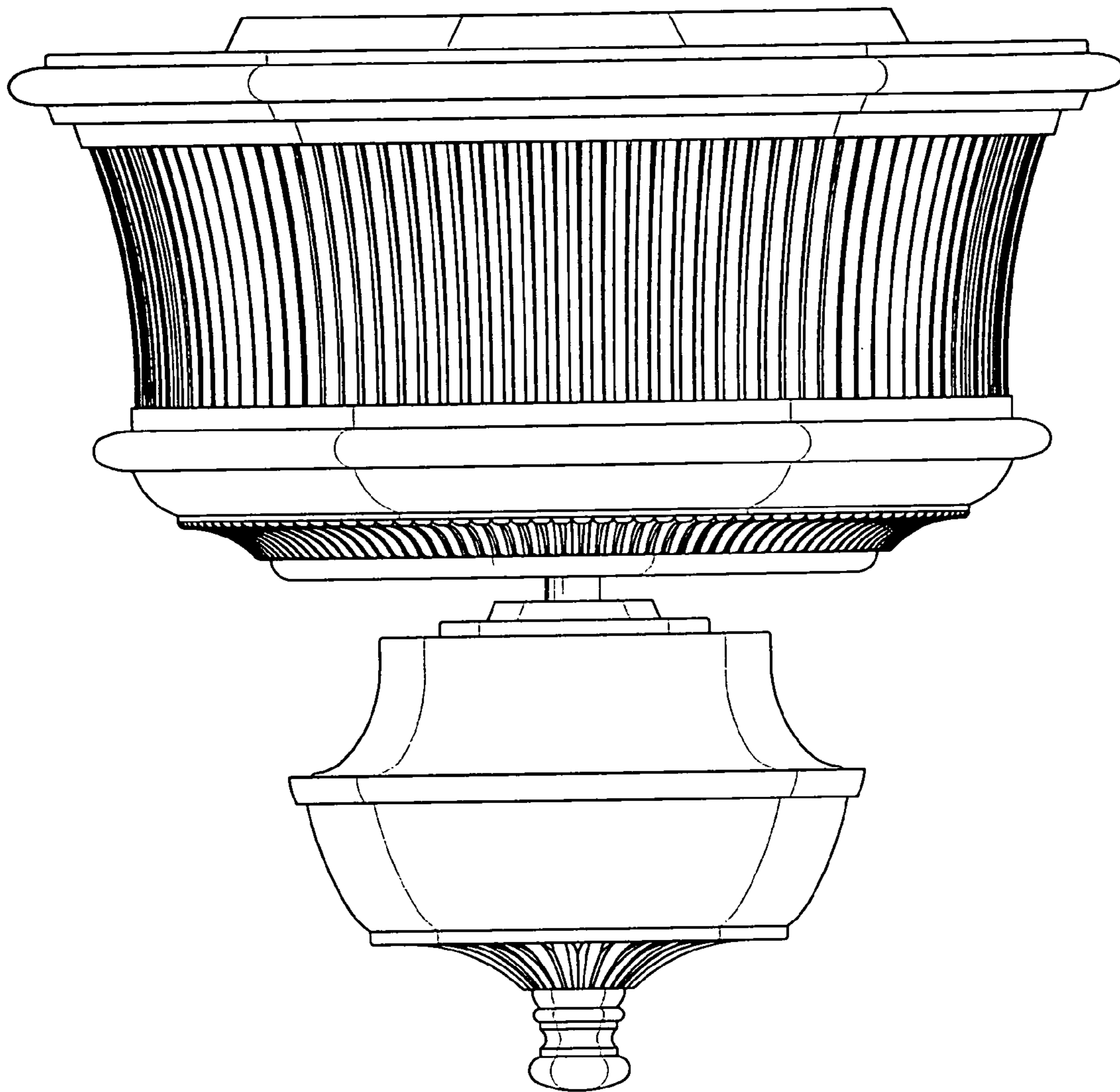

FIG. 3

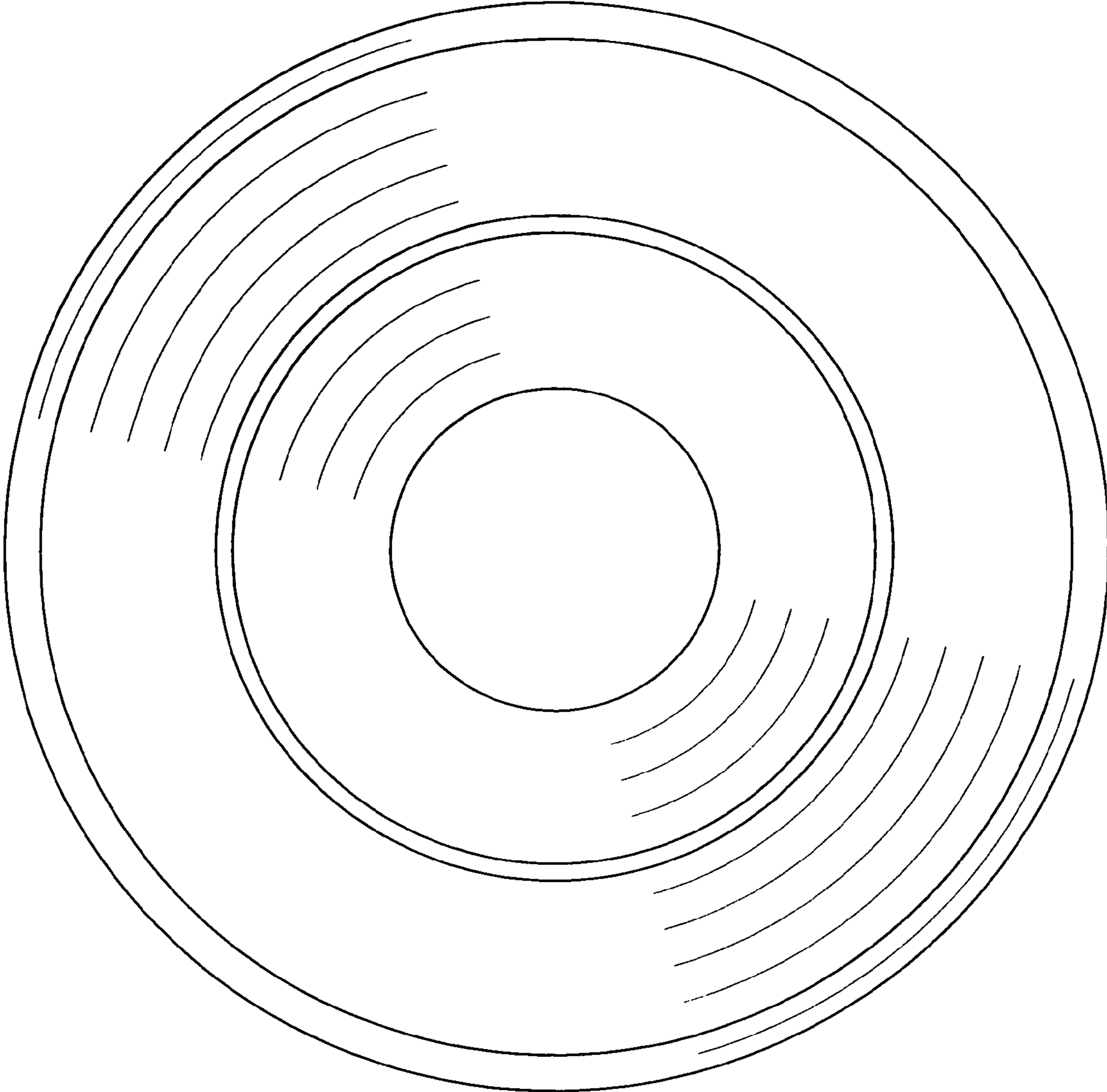

FIG. 4

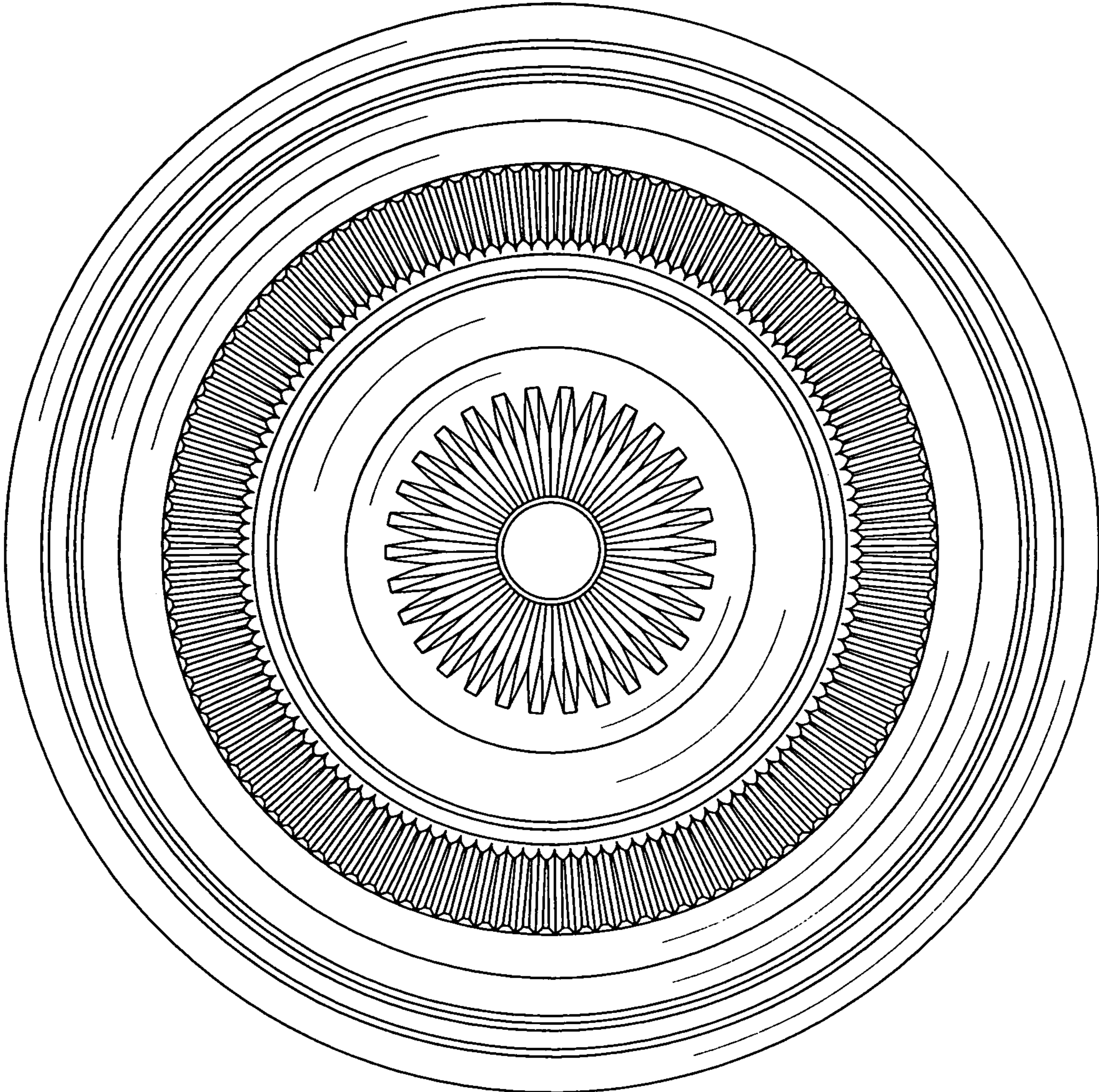

FIG. 5