

US00D544536S

(12) **United States Design Patent**
Motoki et al.

(10) **Patent No.:** **US D544,536 S**
(45) **Date of Patent:** **** Jun. 12, 2007**

(54) **RIBBON CARTRIDGE FOR A THERMAL-TRANSFER PRINTER**
(75) Inventors: **Zenko Motoki**, Fukushima-ken (JP); **Takahito Maruyama**, Fukushima-ken (JP); **Yoshibumi Abe**, Fukushima-ken (JP)

D332,275 S * 1/1993 Katsuno D18/56
D383,743 S * 9/1997 Suwa et al. D18/56
5,709,485 A * 1/1998 Kohno 400/208
D420,696 S * 2/2000 Yung et al. D18/12
D446,239 S * 8/2001 Funaki D18/12
6,962,451 B2 * 11/2005 Narita et al. 400/207
D514,153 S * 1/2006 Tu D18/12
D523,891 S * 6/2006 Tu D18/12

(73) Assignee: **Alps Electric Co., Ltd.**, Tokyo (JP)

* cited by examiner

(**) Term: **14 Years**

Primary Examiner—Cathy Anne MacCormac

(21) Appl. No.: **29/243,598**

(74) *Attorney, Agent, or Firm*—Brinks Hofer Gilson & Lione

(22) Filed: **Nov. 28, 2005**

(57) **CLAIM**

(30) **Foreign Application Priority Data**

The ornamental design for a ribbon cartridge for a thermal-transfer printer, as shown and described.

Jun. 2, 2005 (JP) 2005-015995

(51) **LOC (8) Cl.** **18-02**

(52) **U.S. Cl.** **D18/56**

(58) **Field of Classification Search** D18/12,
D18/40, 43, 56; D14/471, 481, 483; 347/178,
347/214; 399/110; 400/193, 196, 196.1,
400/207–208, 208.1, 240.4, 242, 613
See application file for complete search history.

DESCRIPTION

FIG. 1 is a front view of a ribbon cartridge for a thermal-transfer printer;

FIG. 2 is a rear view thereof;

FIG. 3 is a right side view thereof;

FIG. 4 is a left side view thereof;

FIG. 5 is a top view thereof;

FIG. 6 is a bottom view thereof; and,

FIG. 7 is a top perspective thereof.

(56) **References Cited**

U.S. PATENT DOCUMENTS

4,901,090 A * 2/1990 Ozawa et al. 347/214
4,978,240 A * 12/1990 Katsuno 347/214

1 Claim, 4 Drawing Sheets

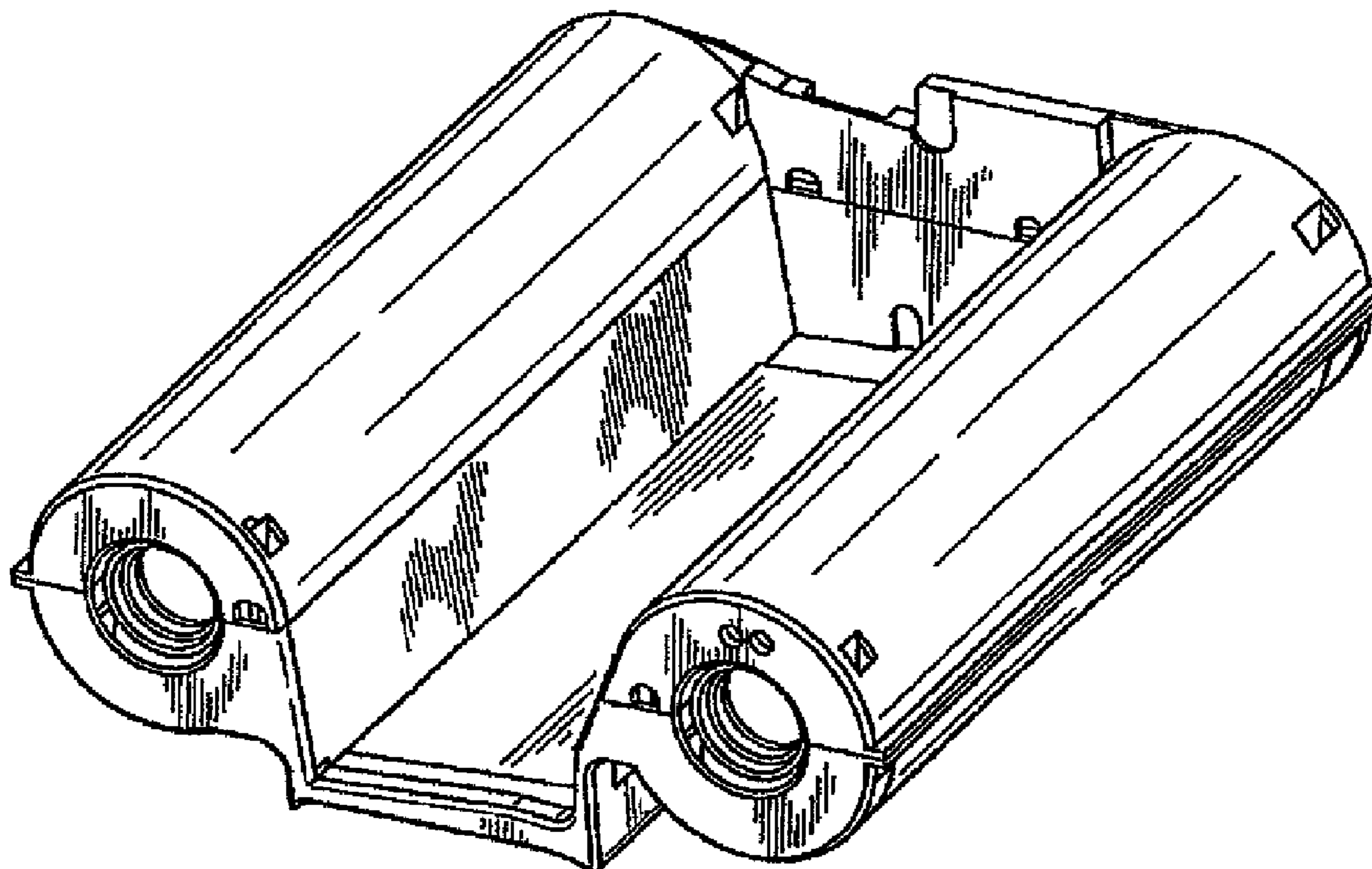

FIG. 1

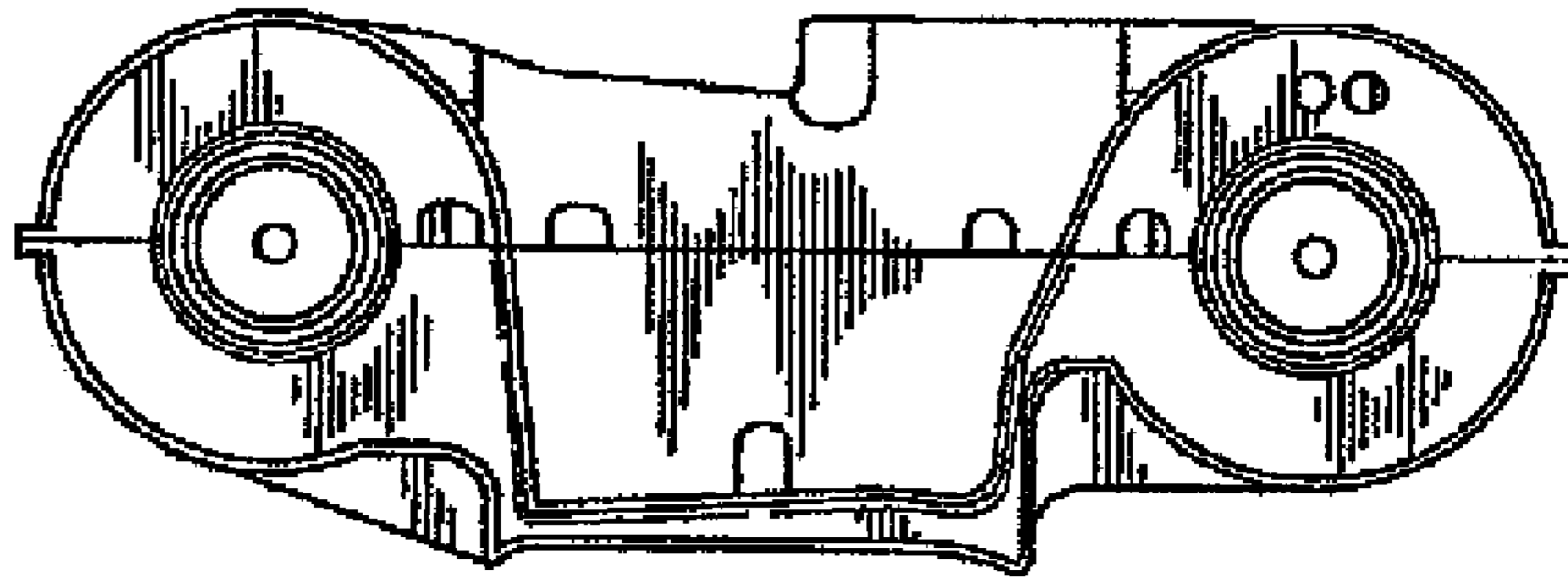

FIG. 2

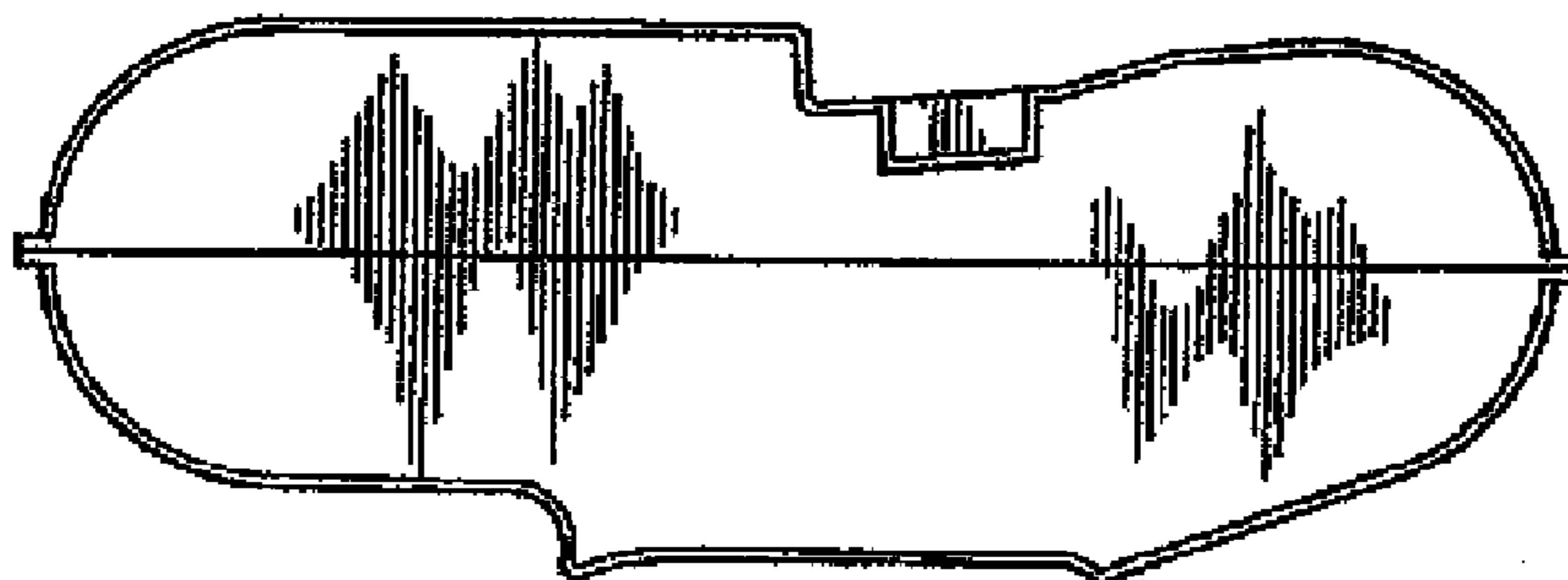

FIG. 3

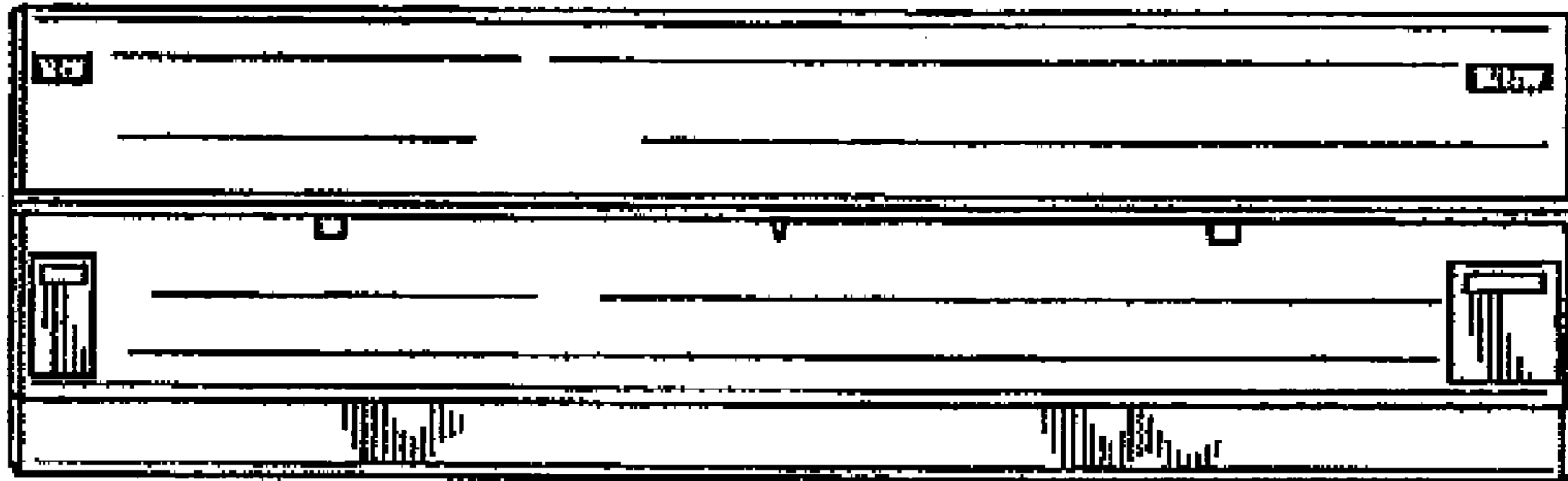

FIG. 4

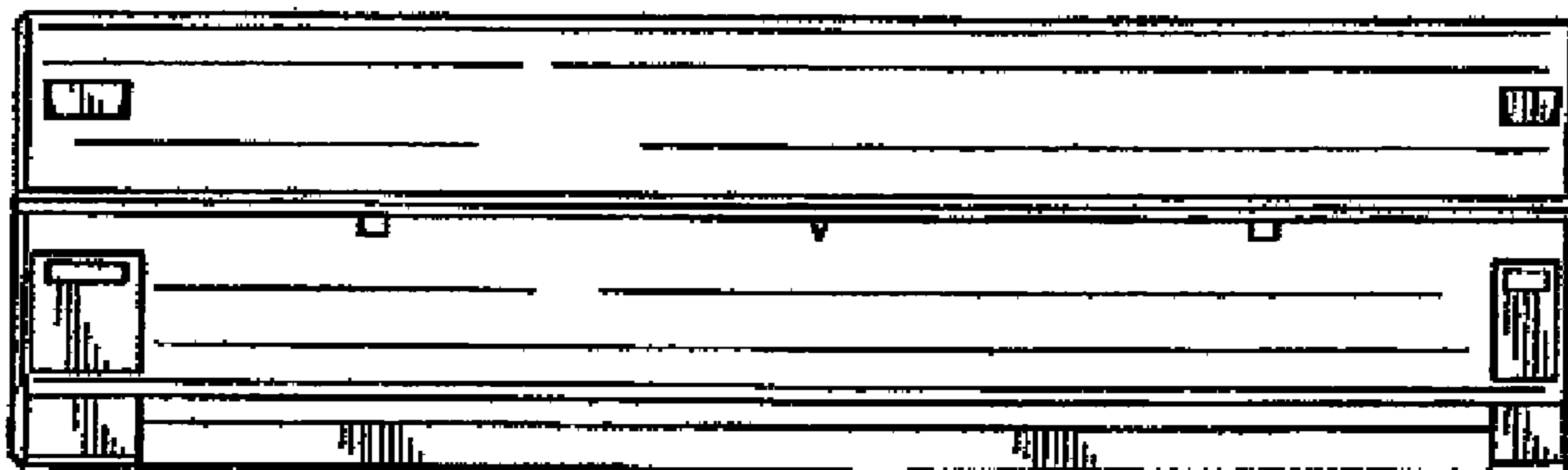

FIG. 5

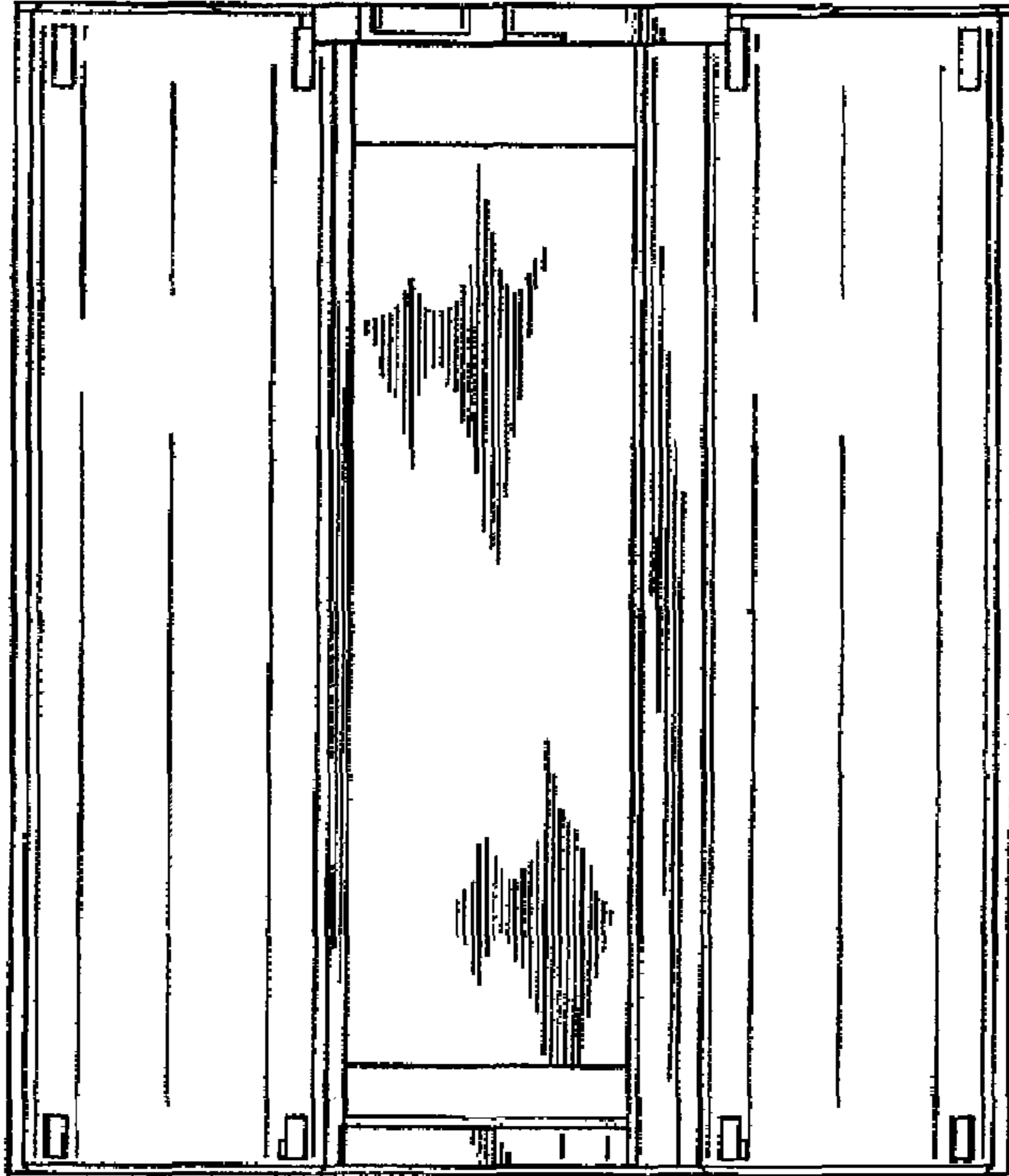

FIG. 6

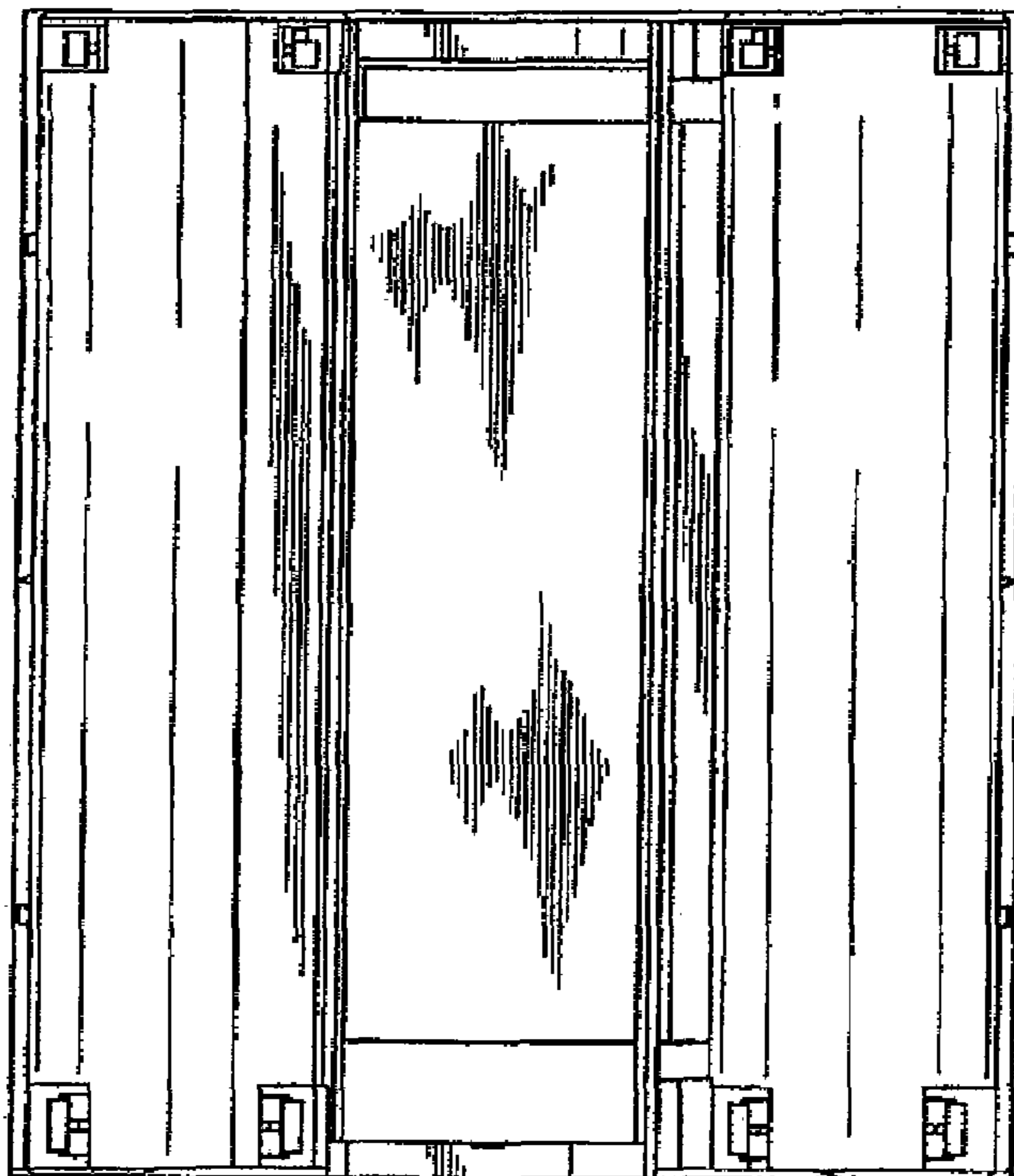

FIG. 7

