

US00D544411S

(12) **United States Design Patent**
Spiva

(10) **Patent No.:** **US D544,411 S**

(45) **Date of Patent:** **** Jun. 12, 2007**

(54) **MOTORCYCLE AIR CLEANER**

(76) **Inventor:** **Lonny Spiva**, 1270 Smoke Tree, La Habra, CA (US) 90631

(**) **Term:** **14 Years**

(21) **Appl. No.:** **29/264,194**

(22) **Filed:** **Aug. 3, 2006**

(51) **LOC (8) Cl.** **12-11**

(52) **U.S. Cl.** **D12/114; D12/126**

(58) **Field of Classification Search** D12/110,
D12/114, 126; D15/1-5; 280/288.4, 304.3;
180/219; 123/195 C, 198 E; D23/364, 365;
55/385.3

See application file for complete search history.

(56) **References Cited**

OTHER PUBLICATIONS

Custom Chrome® Chrome Specialties® 2003 catalog, Siren Air Cleaner on p. 8.36, and Finned Teardrop Air Cleaner Assembly and Teardrop Air Cleaner Assembly shown on p. 8.38.*

* cited by examiner

Primary Examiner—Alan P. Douglas

Assistant Examiner—Linda Brooks

(74) *Attorney, Agent, or Firm*—Sandy Lipkin

(57) **CLAIM**

The ornamental design for a motorcycle air cleaner, as shown and described.

DESCRIPTION

FIG. 1 is a perspective view thereof;
FIG. 2 is a front elevational view thereof;
FIG. 3 is a right side elevational view thereof;
FIG. 4 is a left side elevational view thereof;
FIG. 5 is a rear elevational view thereof;
FIG. 6 is a top plan view thereof; and,
FIG. 7 is a bottom plan view thereof.

1 Claim, 2 Drawing Sheets

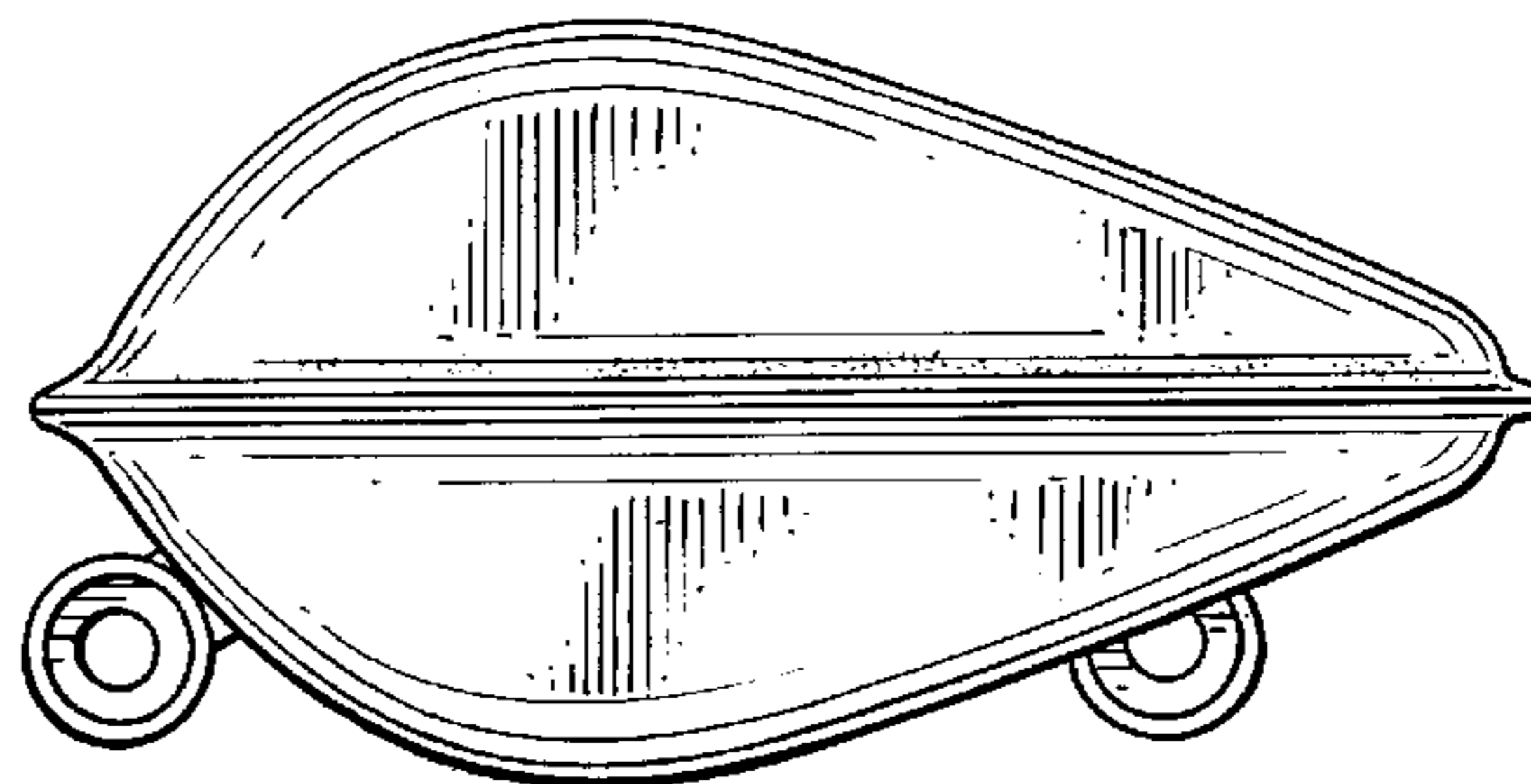
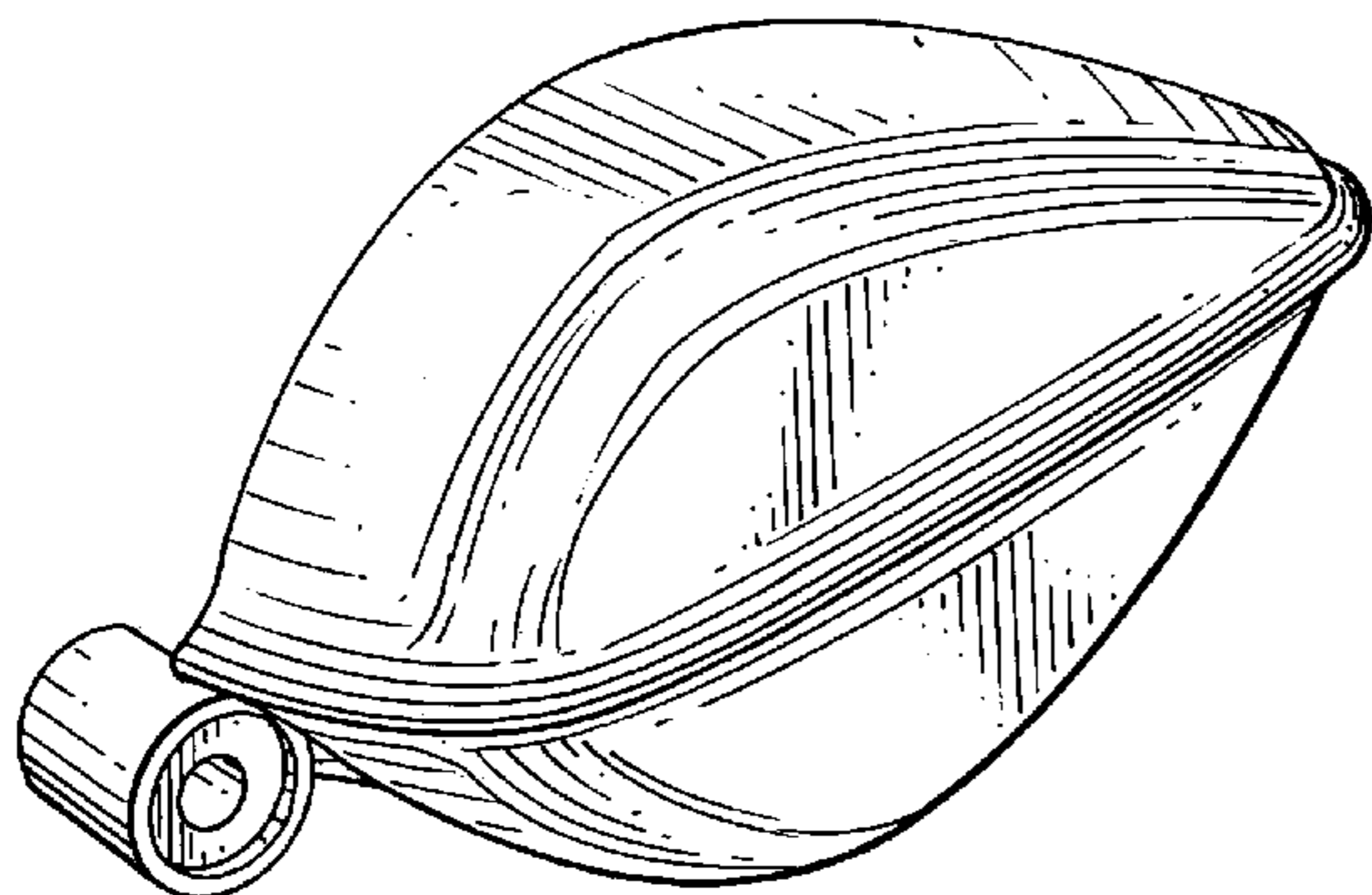

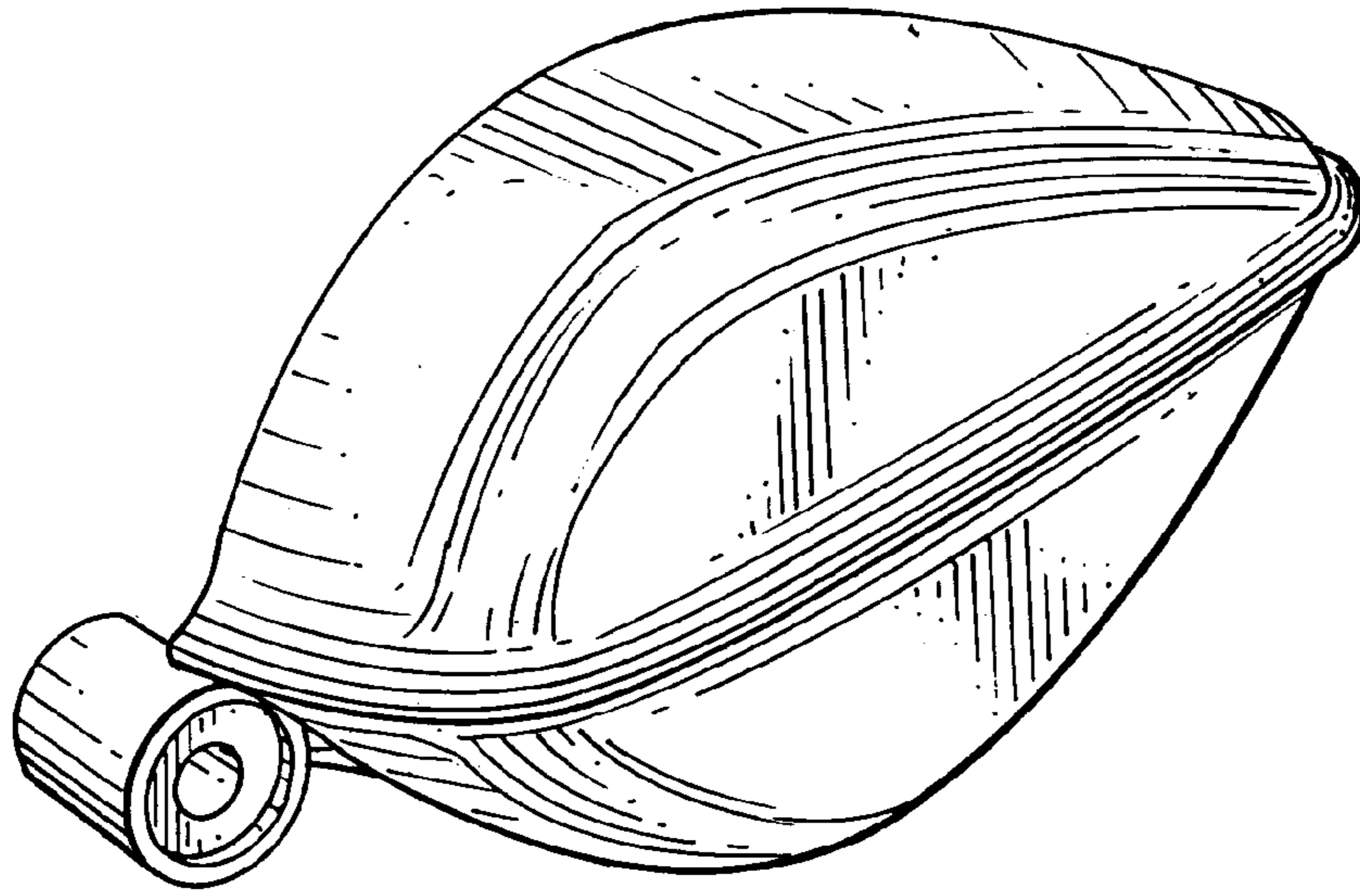

Fig. 1.

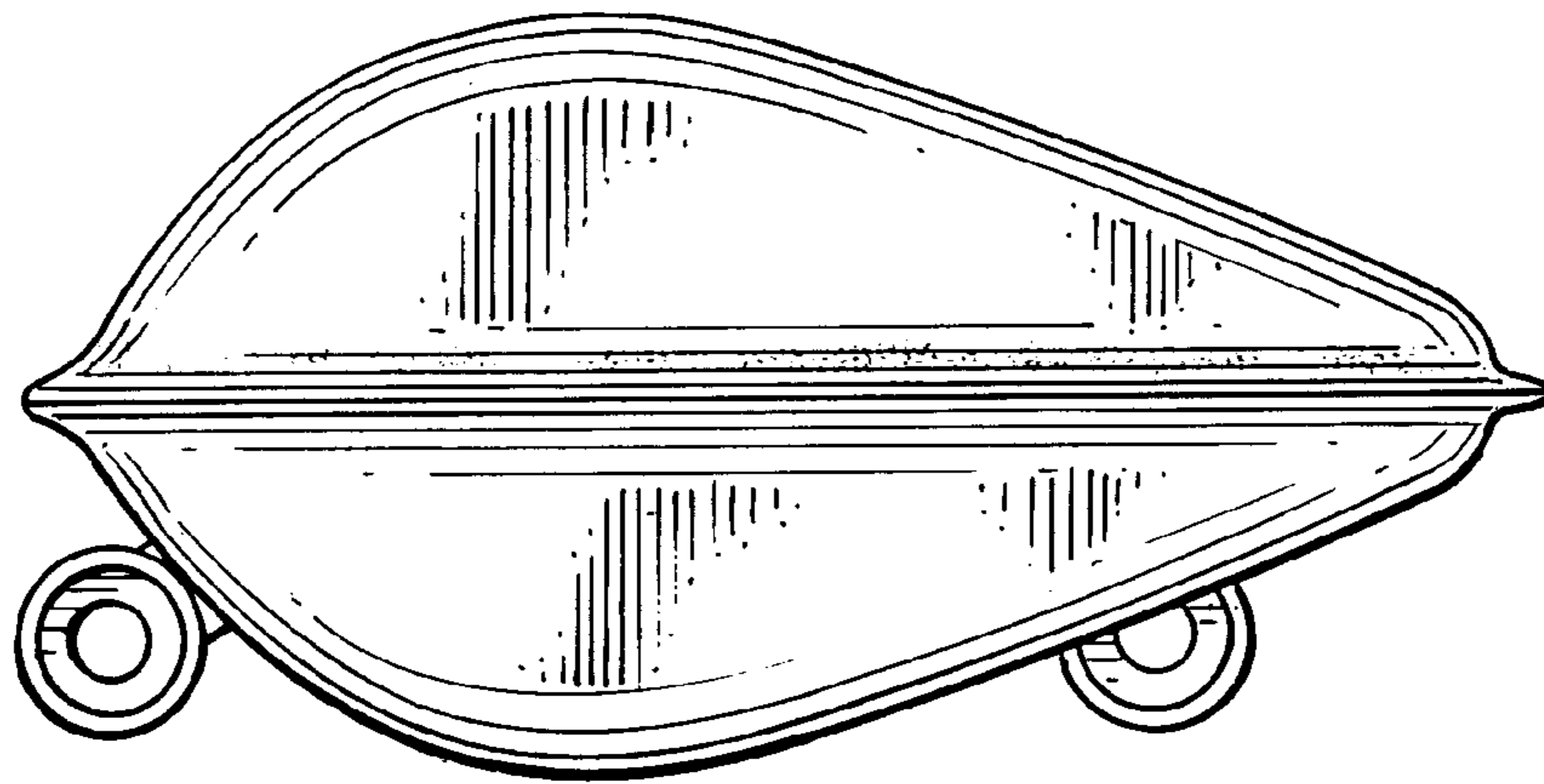

Fig. 2.

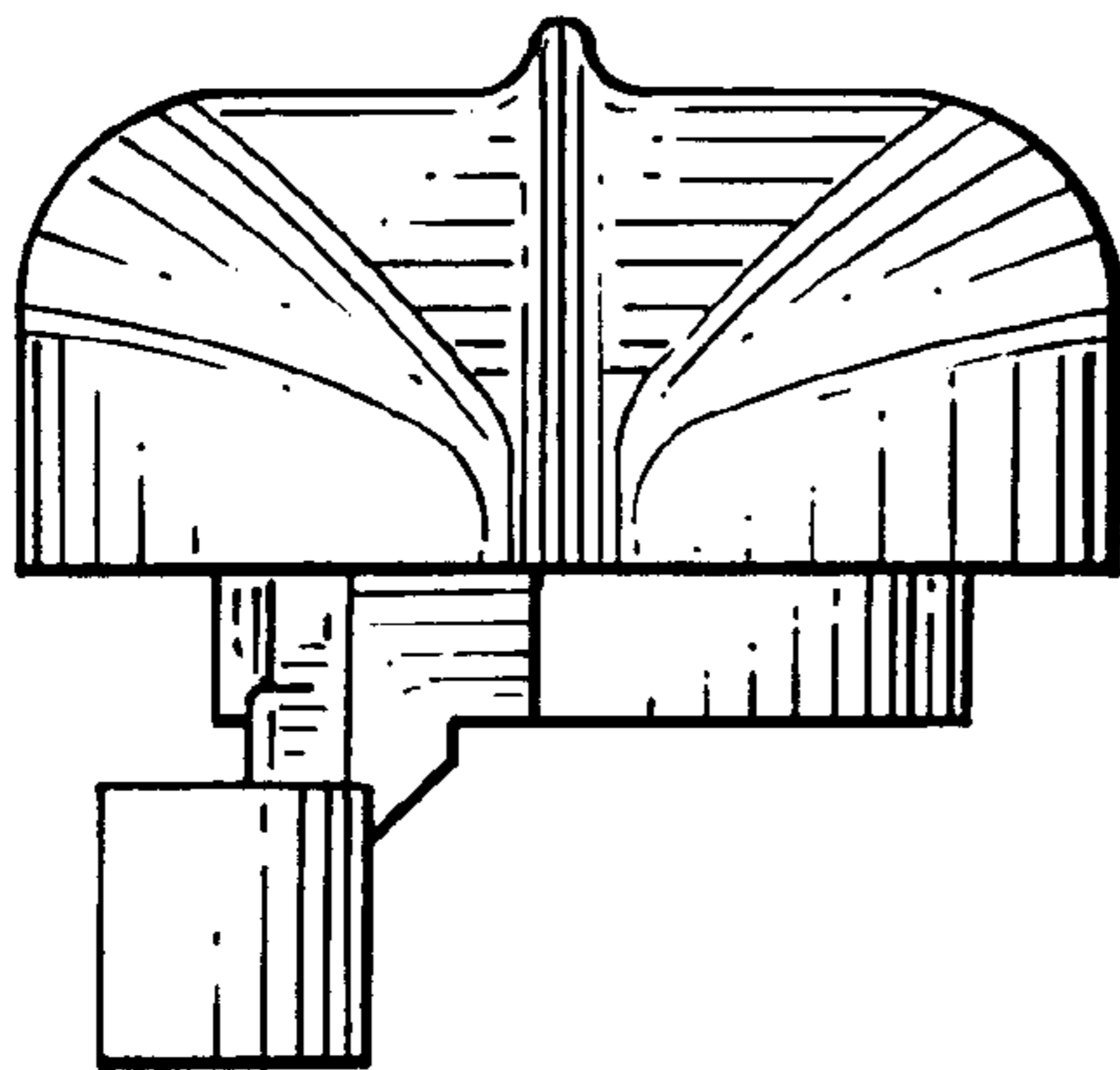

Fig. 3.

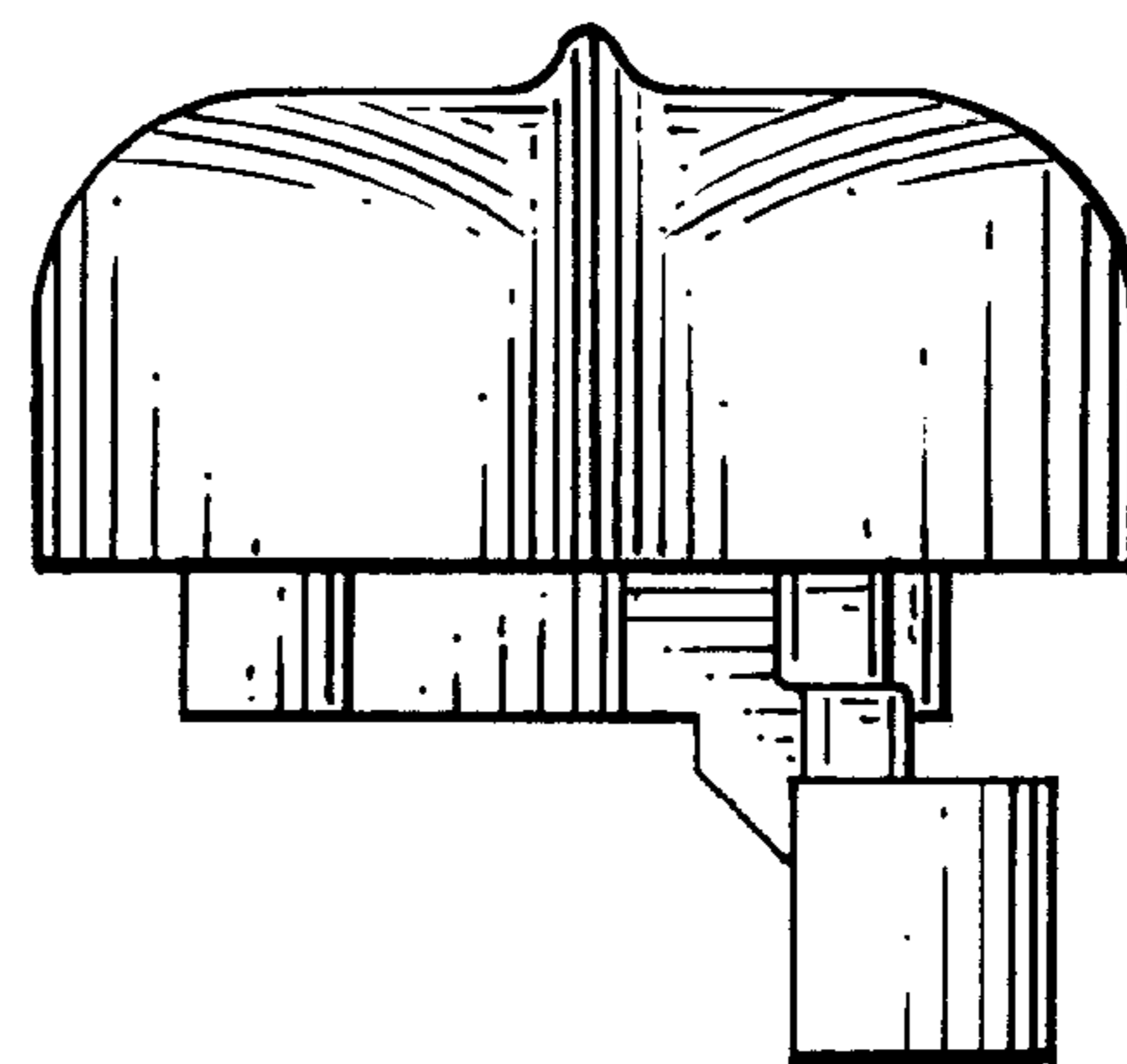

Fig. 4.

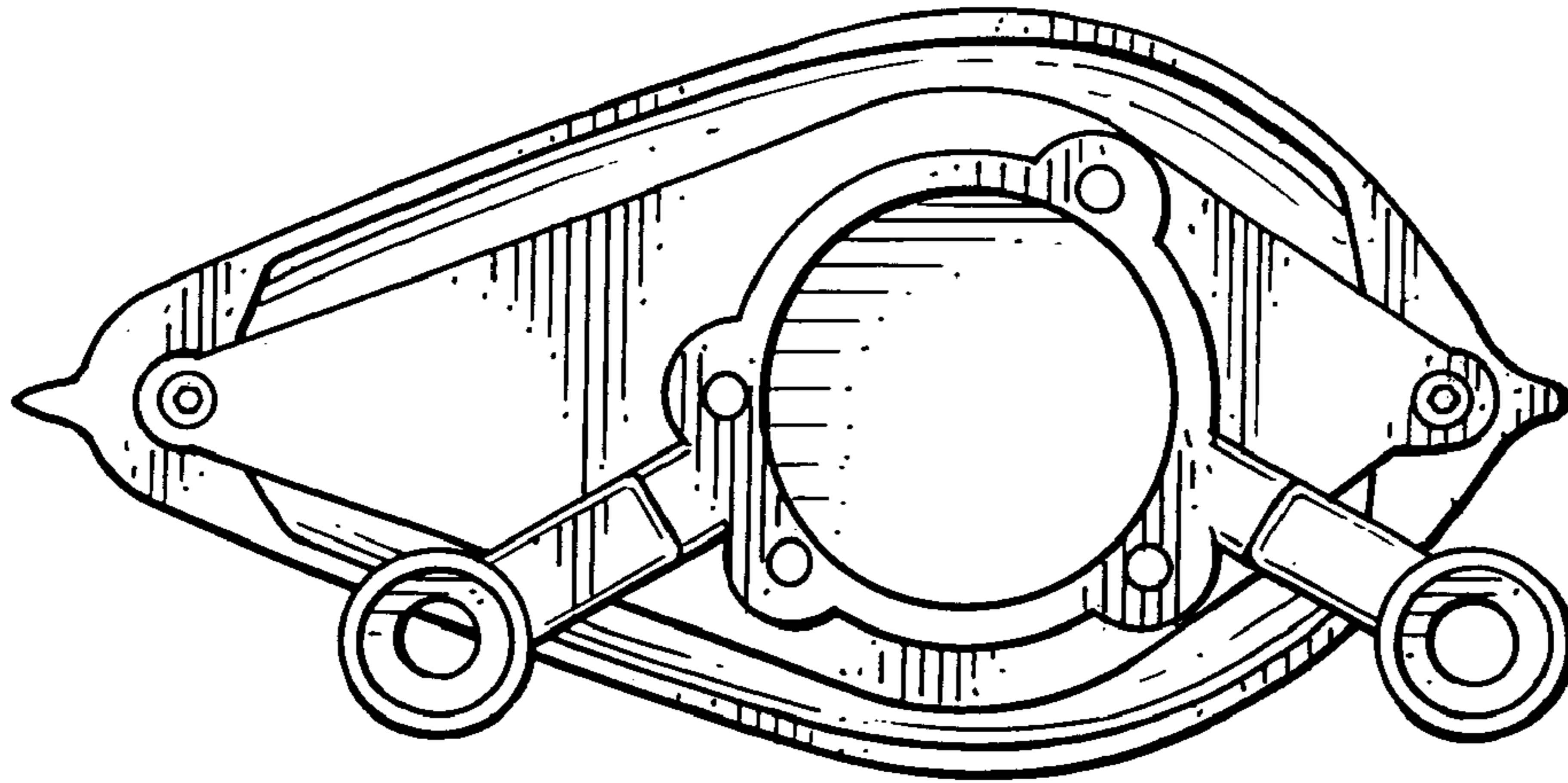

Fig. 5.

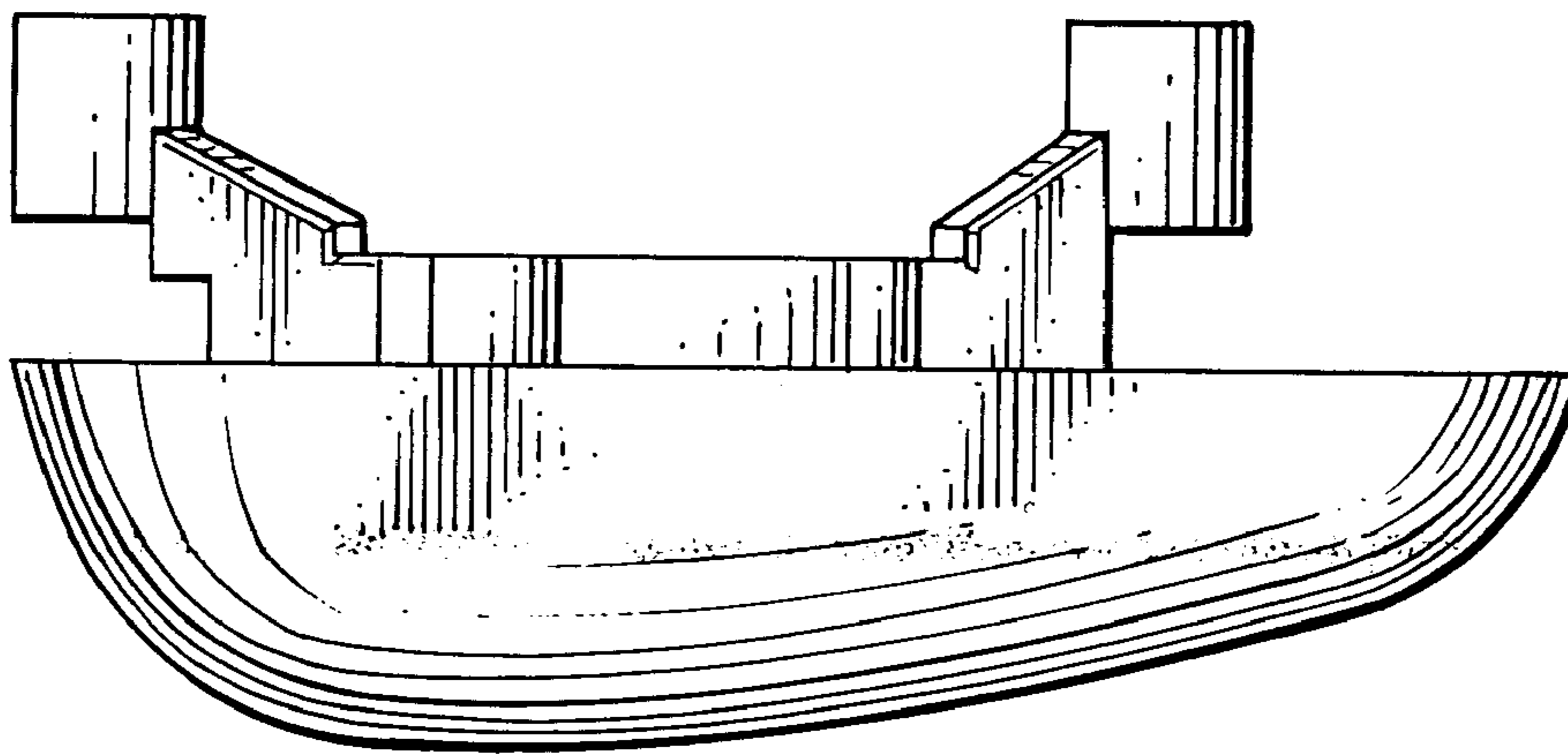

Fig. 6.

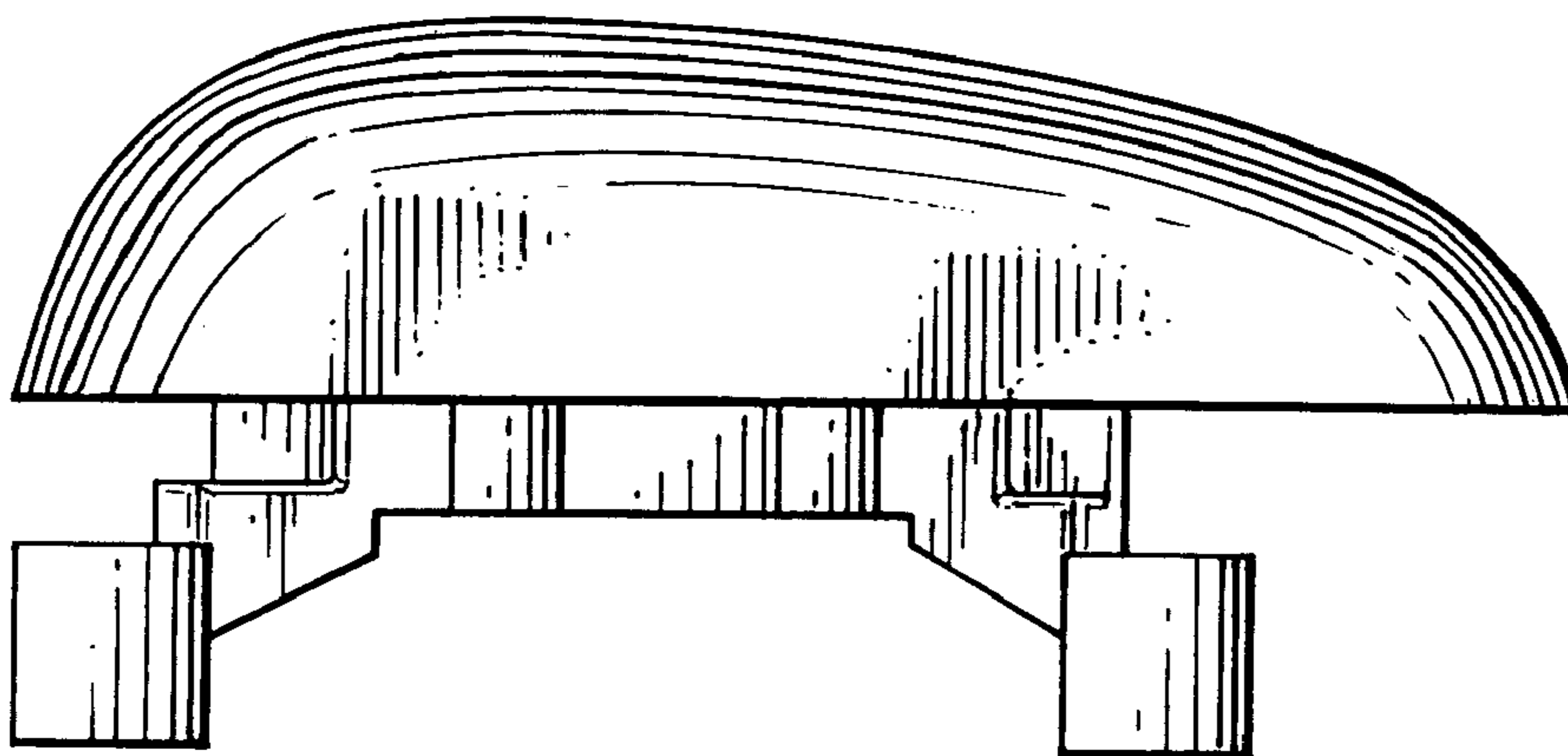

Fig. 7.