



US00D544354S

(12) **United States Design Patent**
Lankford

(10) **Patent No.:** **US D544,354 S**

(45) **Date of Patent:** **** Jun. 12, 2007**

(54) **BOTTLE**

(75) Inventor: **Audrey Anne Lankford**, Cornelius, NC (US)

(73) Assignee: **Irwin Industrial Tool Company**, Huntersville, NC (US)

(**) Term: **14 Years**

(21) Appl. No.: **29/222,638**

(22) Filed: **Feb. 2, 2005**

(51) **LOC (8) Cl.** **09-01**

(52) **U.S. Cl.** **D9/516**

(58) **Field of Classification Search** D9/434,
D9/449-457, 516, 541-544, 551, 552, 667,
D9/563-570; D10/104, 106, 116, 119-121;
D14/168, 187, 207; D23/314, 386-388;
215/382-384; 220/669, 675

See application file for complete search history.

(56) **References Cited**

U.S. PATENT DOCUMENTS

- D98,382 S * 1/1936 Barbiers D9/563
- 2,994,259 A * 8/1961 O'Day 454/300
- D212,322 S * 10/1968 Koenigsberg D9/667
- D215,976 S * 11/1969 Bernt D10/120
- D256,433 S * 8/1980 Kretz D7/300
- D276,029 S * 10/1984 Skarman D10/106
- D313,172 S * 12/1990 Nilsen D8/400
- 5,279,433 A * 1/1994 Krishnakumar et al. 215/381
- D528,427 S * 9/2006 Sasaki et al. D9/541
- 2006/0054587 A1 * 3/2006 Oguchi et al. 215/381

* cited by examiner

Primary Examiner—Prabhakar Deshmukh

Assistant Examiner—Keli' L. Acker

(74) *Attorney, Agent, or Firm*—Dennis J. Williamson;
Moore & Van Allen PLLC

(57) **CLAIM**

The ornamental design for a bottle, as shown and described.

DESCRIPTION

FIG. 1 is a perspective view showing a first embodiment of my new design for a bottle;

FIG. 2 is a front view showing my new design shown in FIG. 1;

FIG. 3 is a side view showing my new design shown in FIG. 1 and wherein the left side view of my design is a mirror image of the right side view of FIG. 3;

FIG. 4 is a back view of the bottle incorporating my design shown in FIG. 1;

FIG. 5 is a top view of the bottle incorporating my design shown in FIG. 1;

FIG. 6 is a bottom view of the bottle incorporating my design shown in FIG. 1;

FIG. 7 is a perspective view showing a second embodiment of my new design for a bottle;

FIG. 8 is a front view showing my new design shown in FIG. 7;

FIG. 9 is a side view showing my new design shown in FIG. 7 and wherein the left side view of my design is a mirror image of the right side view of FIG. 9;

FIG. 10 is a back view of the bottle incorporating my design shown in FIG. 7;

FIG. 11 is a top view of the bottle incorporating my design shown in FIG. 7;

FIG. 12 is a bottom view of the bottle incorporating my design shown in FIG. 7;

FIG. 13 is a perspective view showing a third embodiment of my new design for a bottle;

FIG. 14 is a front view showing my new design shown in FIG. 13;

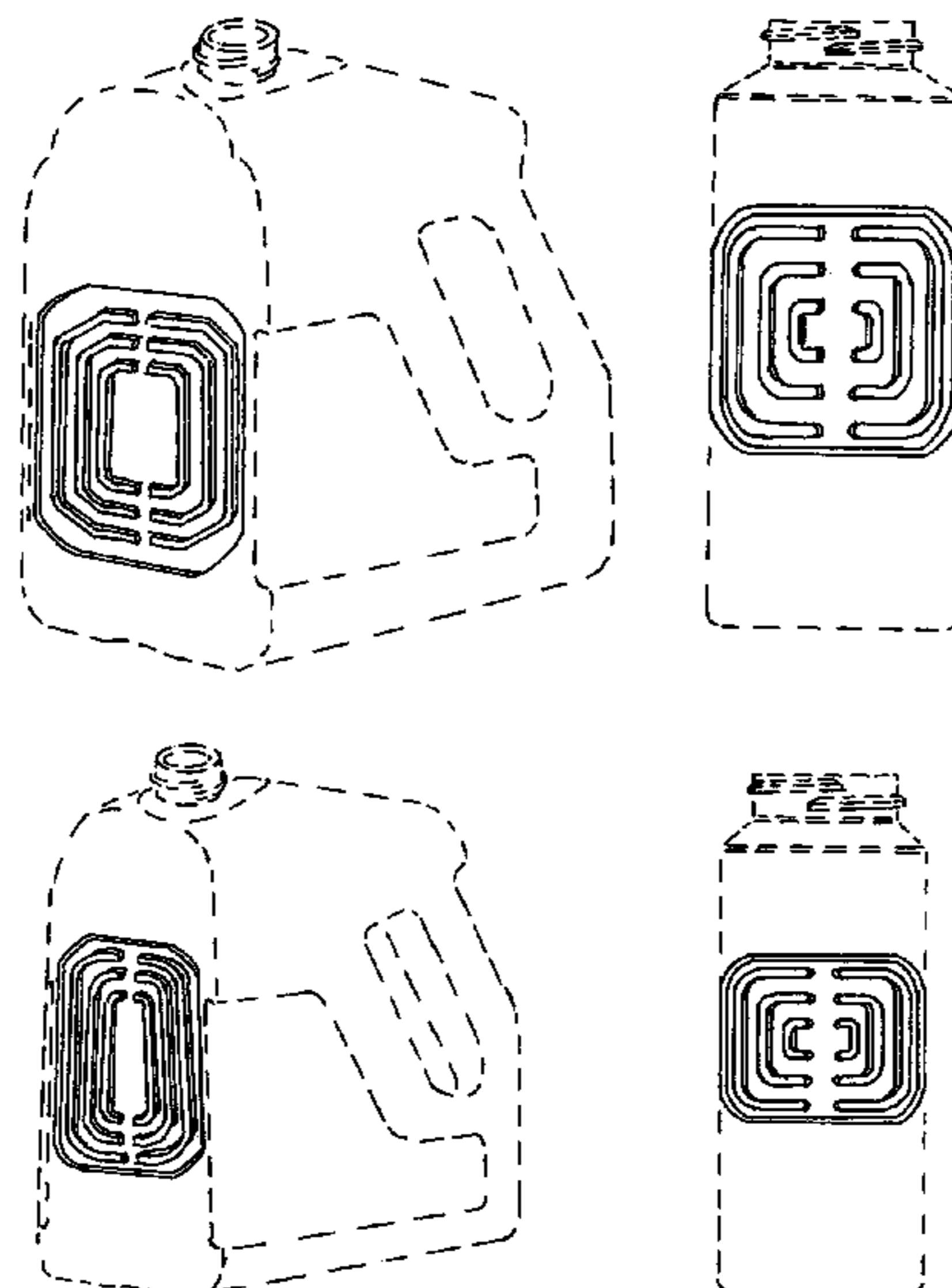

FIG. 15 is a side view showing my new design shown in FIG. 13 and wherein the left side view of my design is a mirror image of the right side view of FIG. 15;

FIG. 16 is a back view of the bottle incorporating my design shown in FIG. 13;

FIG. 17 is a top view of the bottle incorporating my design shown in FIG. 13;

FIG. 18 is a bottom view of the bottle incorporating my design shown in FIG. 13;

FIG. 19 is a perspective view showing a fourth embodiment of my new design for a bottle;

FIG. 20 is a front view showing my new design shown in FIG. 19;

FIG. 21 is a side view showing my new design shown in FIG. 19 and wherein the left side view of my design is a mirror image of the right side view of FIG. 21;

FIG. 22 is a back view of the bottle incorporating my design shown in FIG. 19;

FIG. 23 is a top view of the bottle incorporating my design shown in FIG. 19; and,

FIG. 24 is a bottom view of the bottle incorporating my design shown in FIG. 19.

The broken line showing of the bottle is included for the purpose of illustrating environmental structure and forms no part of the claimed design.

1 Claim, 8 Drawing Sheets

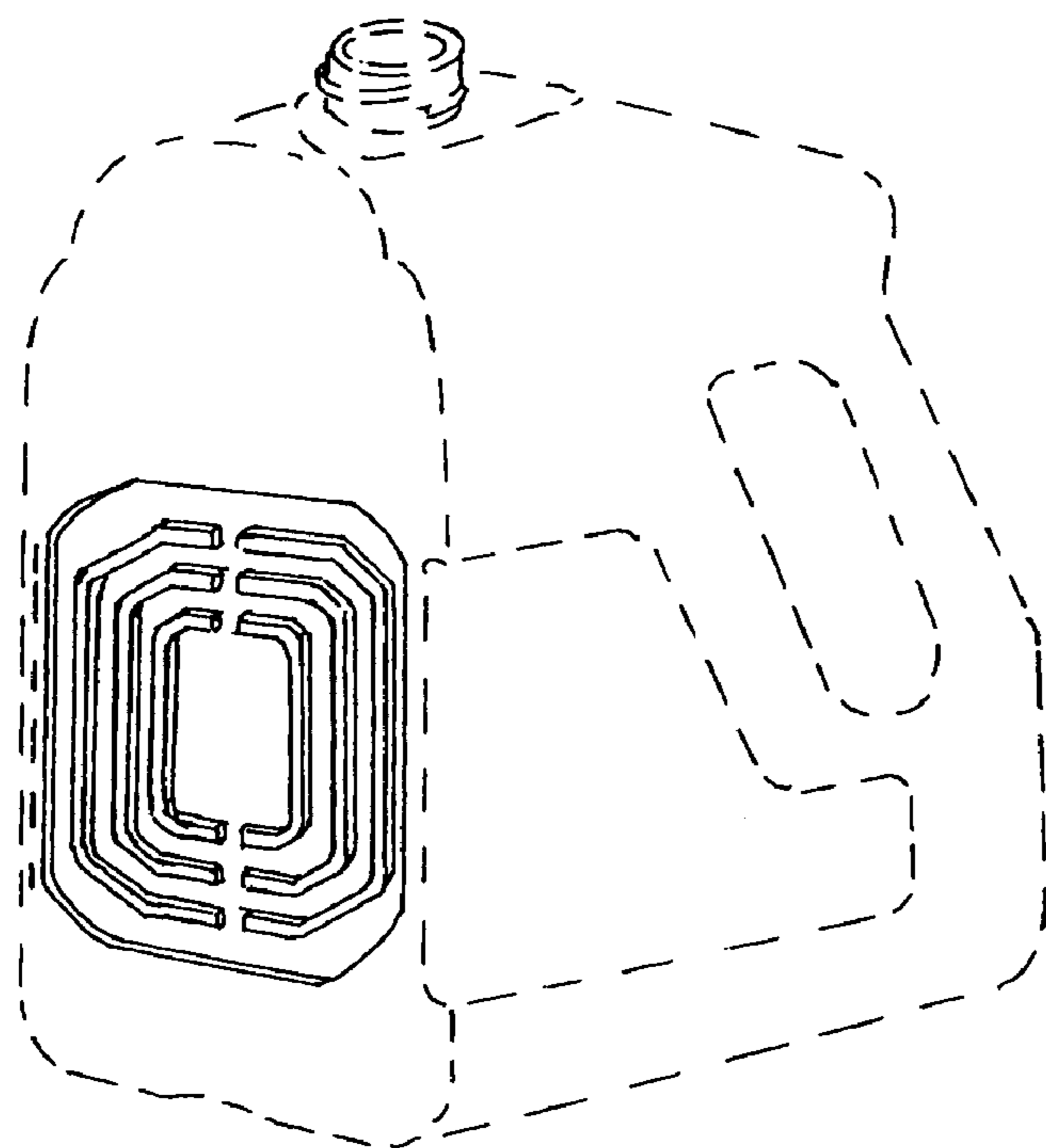

FIG. 1

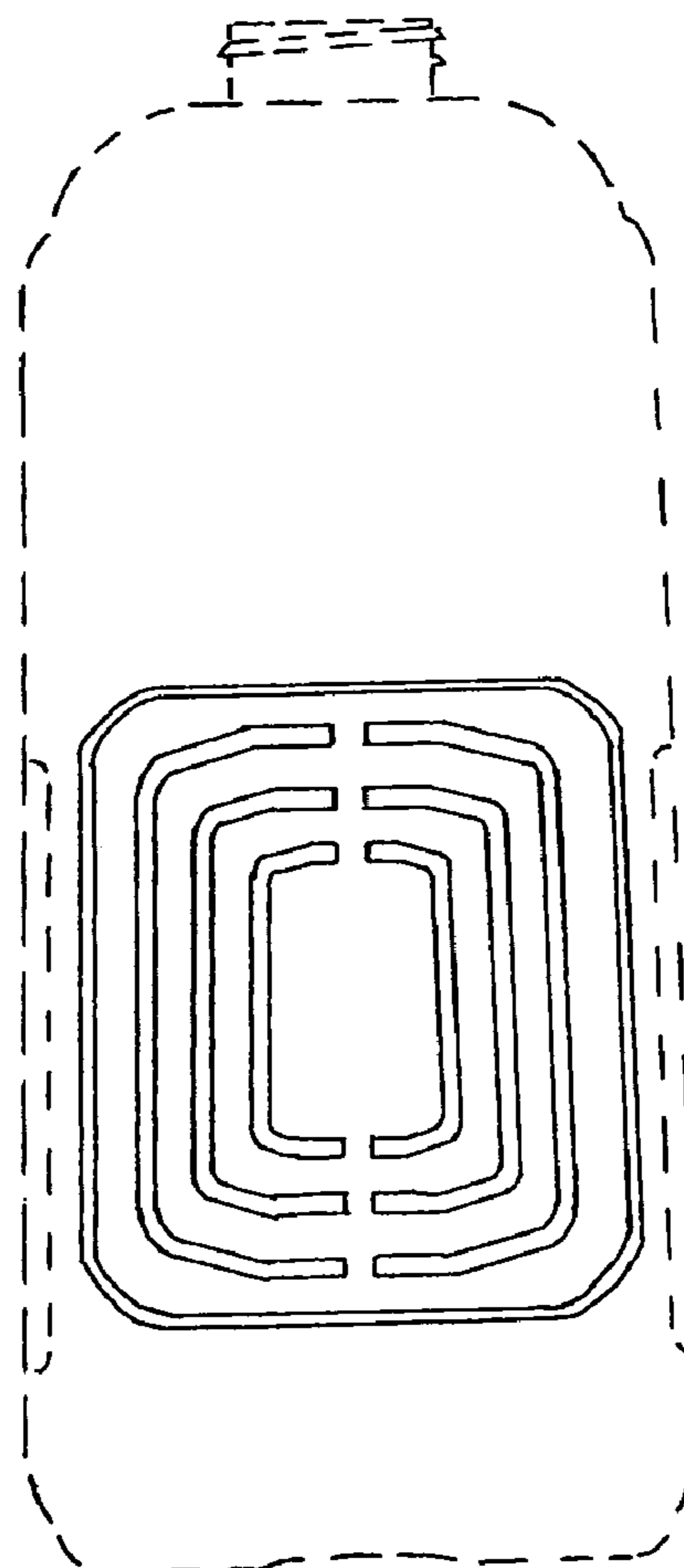

FIG. 2

FIG. 3

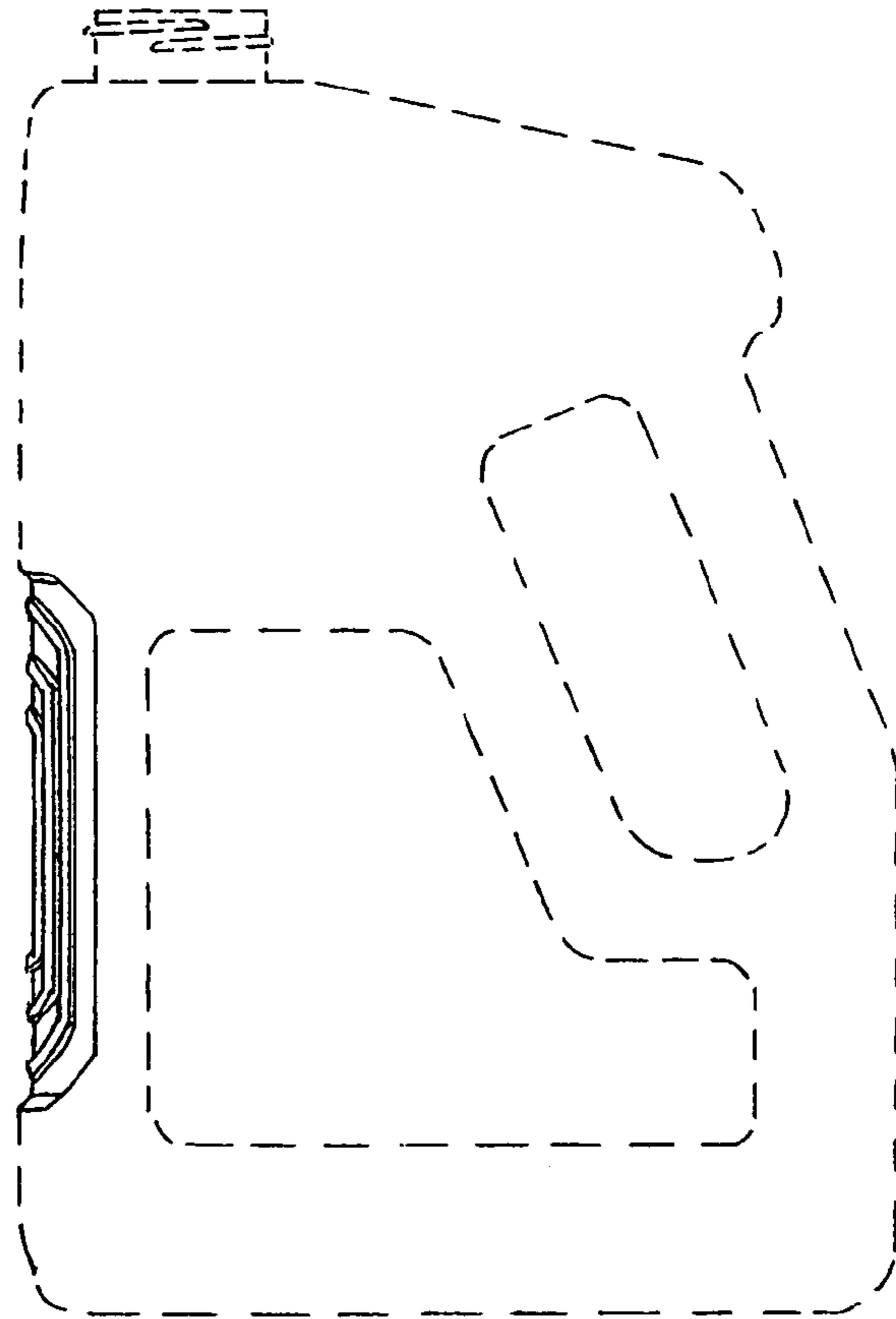
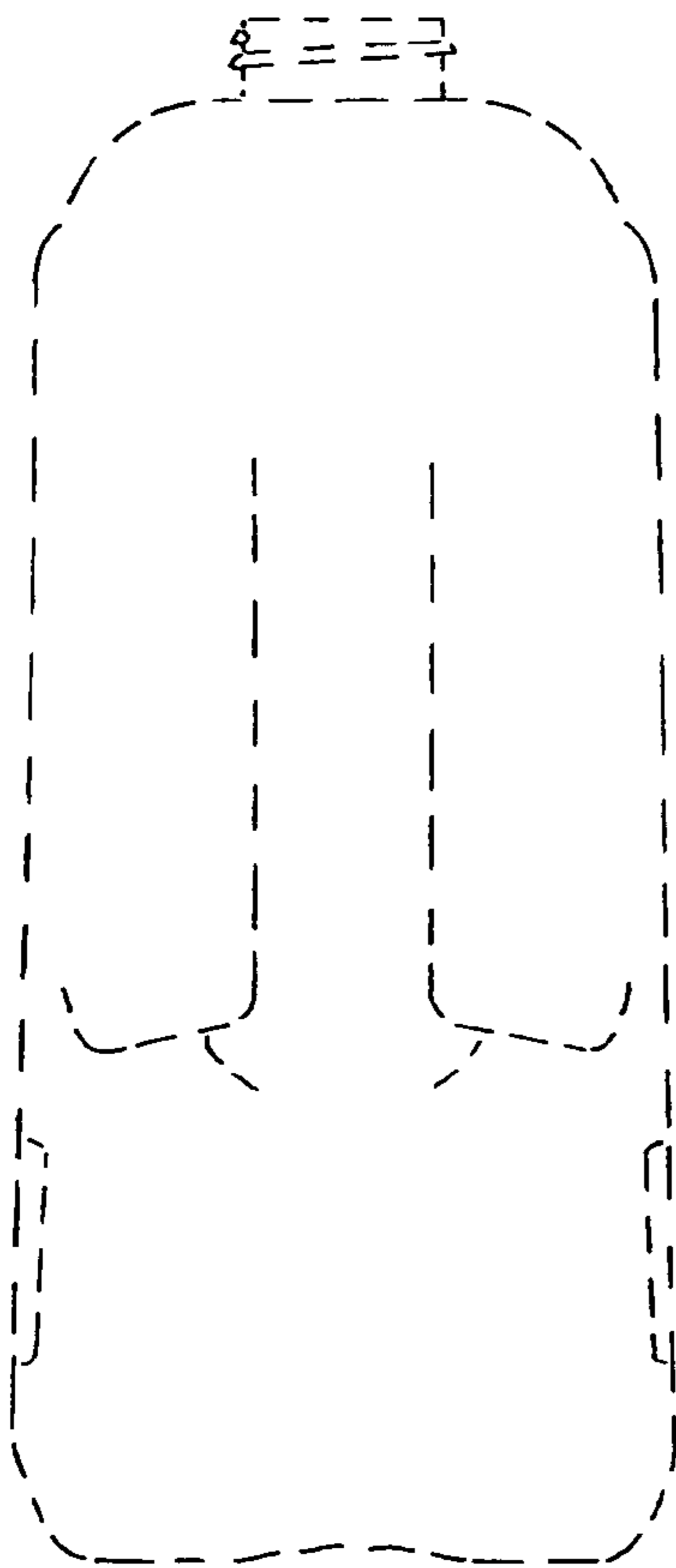

FIG. 4



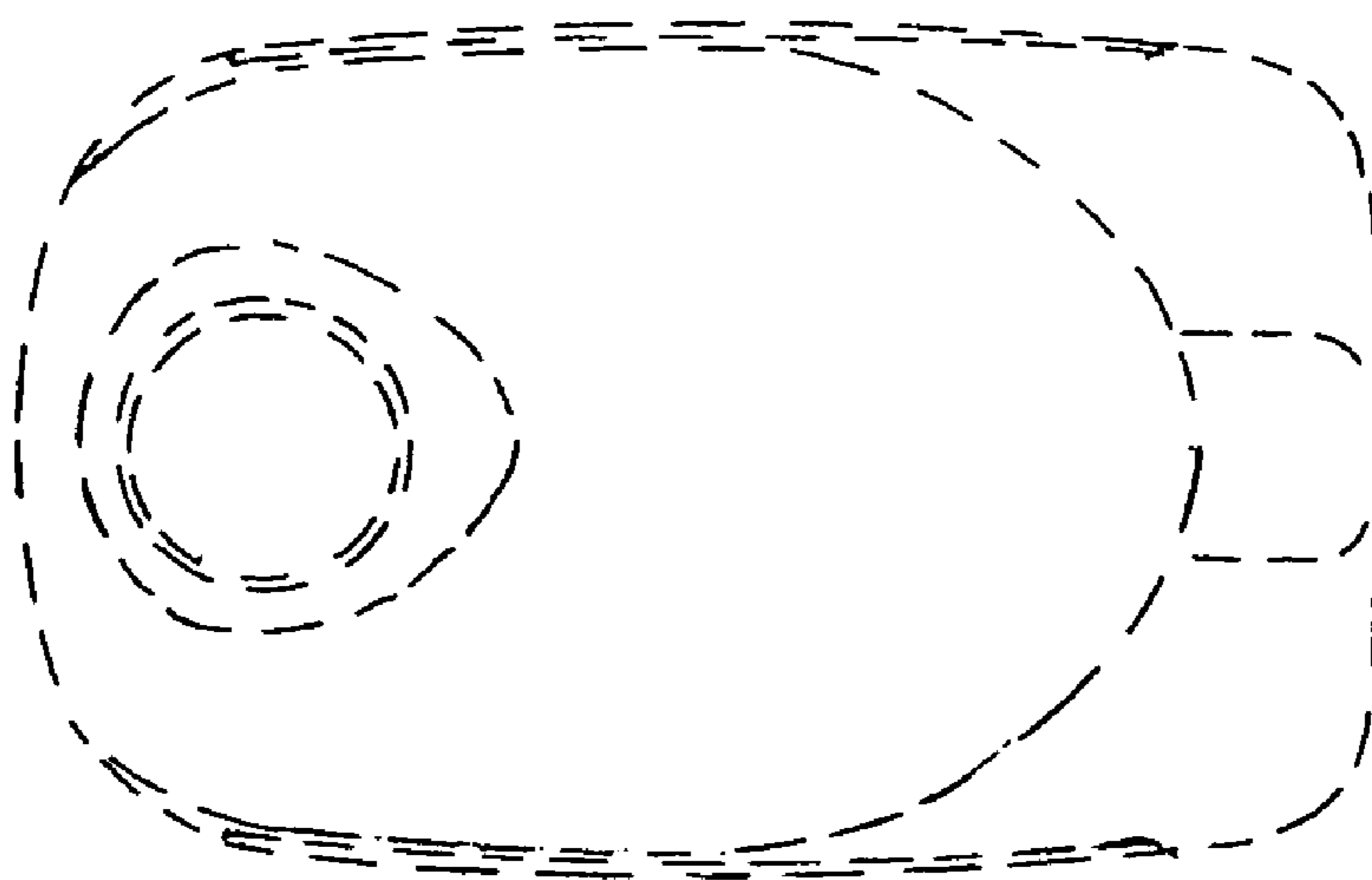

FIG. 5

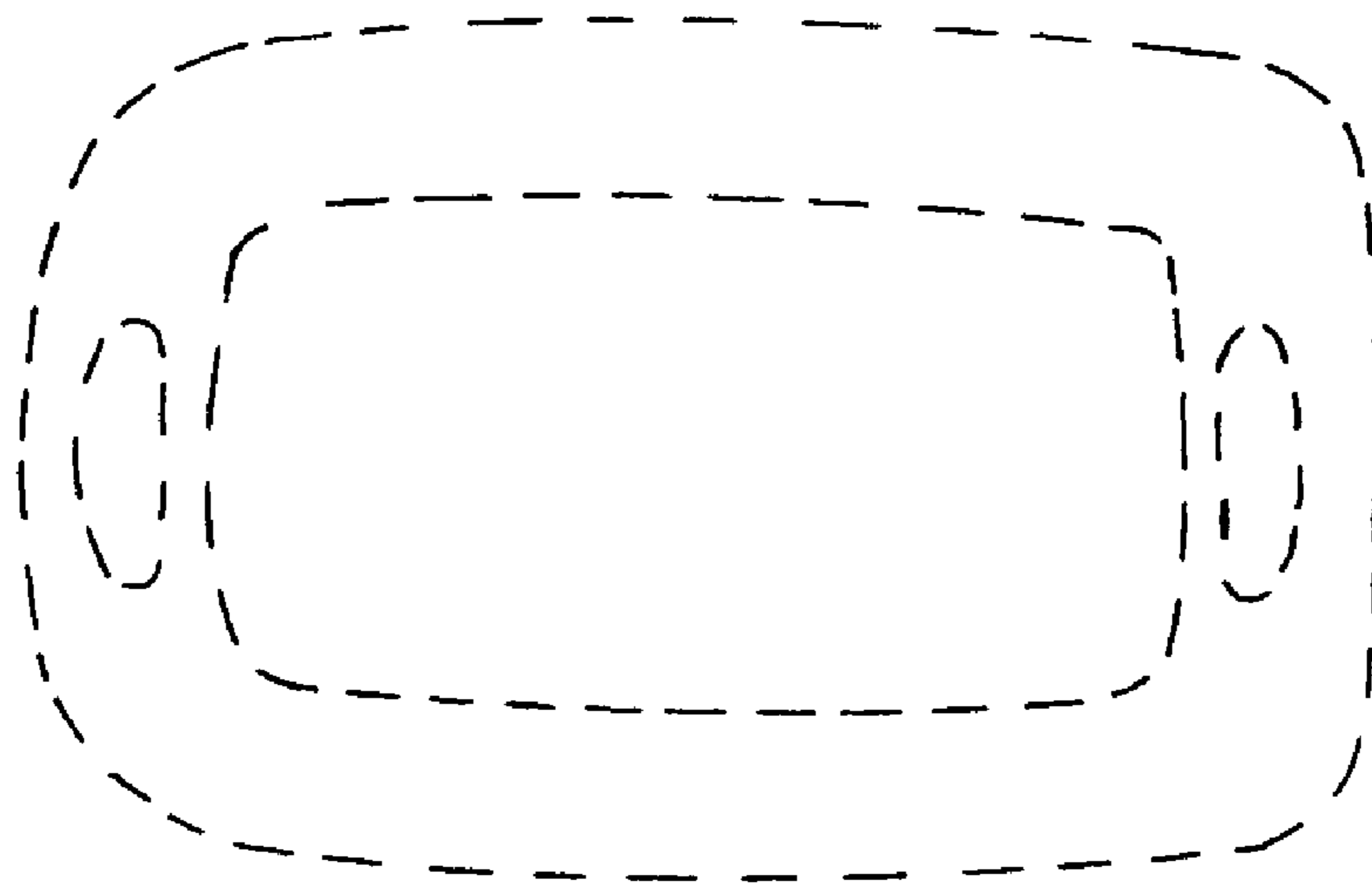

FIG. 6

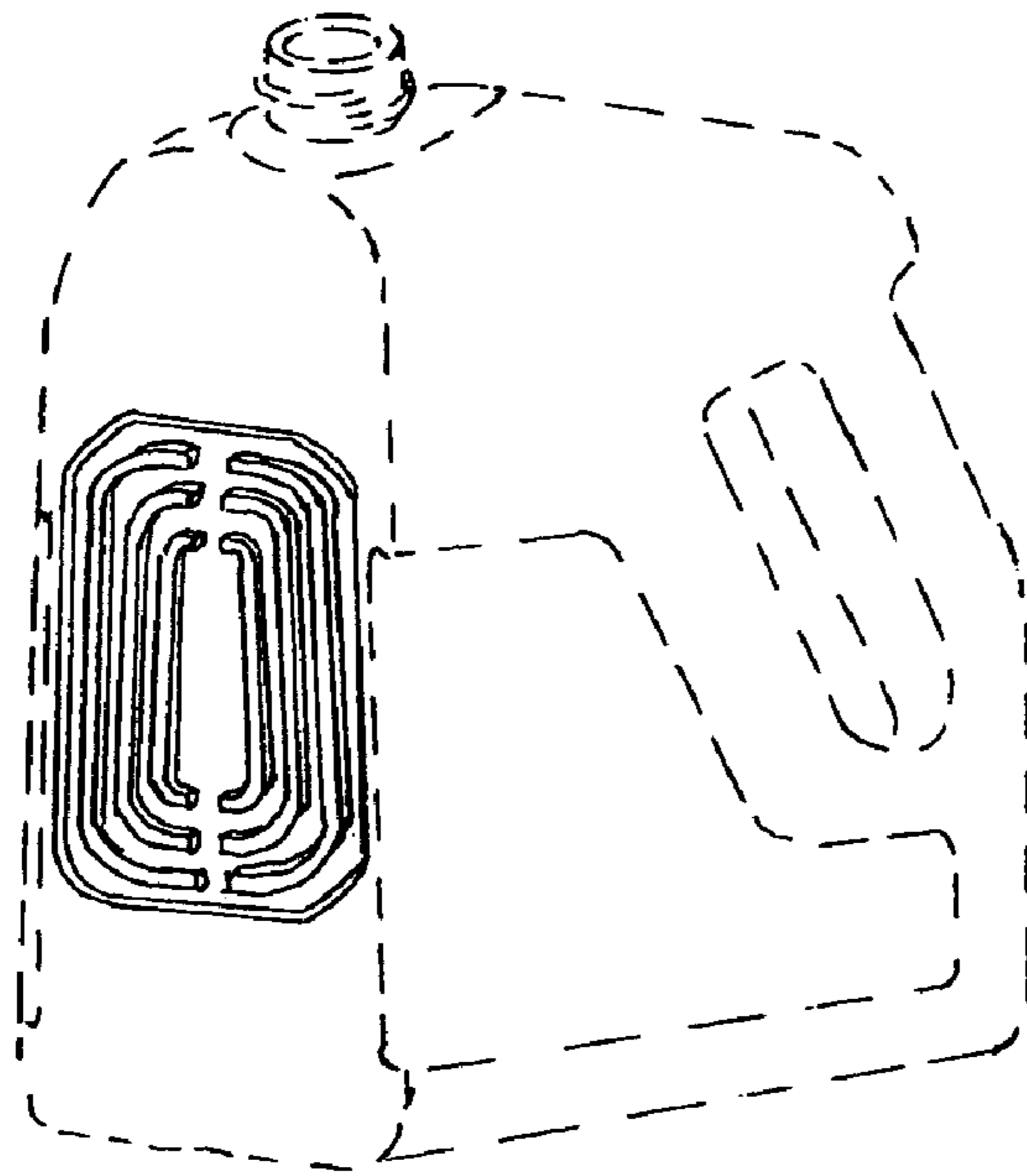

FIG. 7

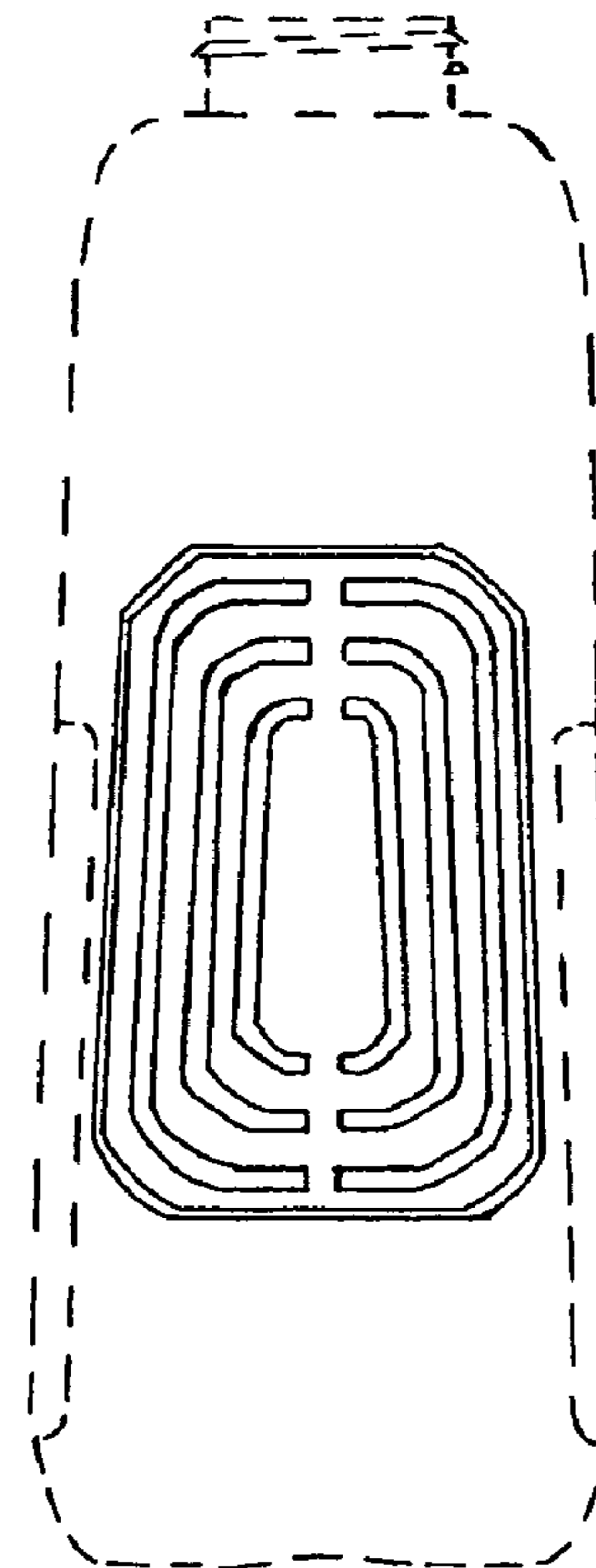

FIG. 8

FIG. 9

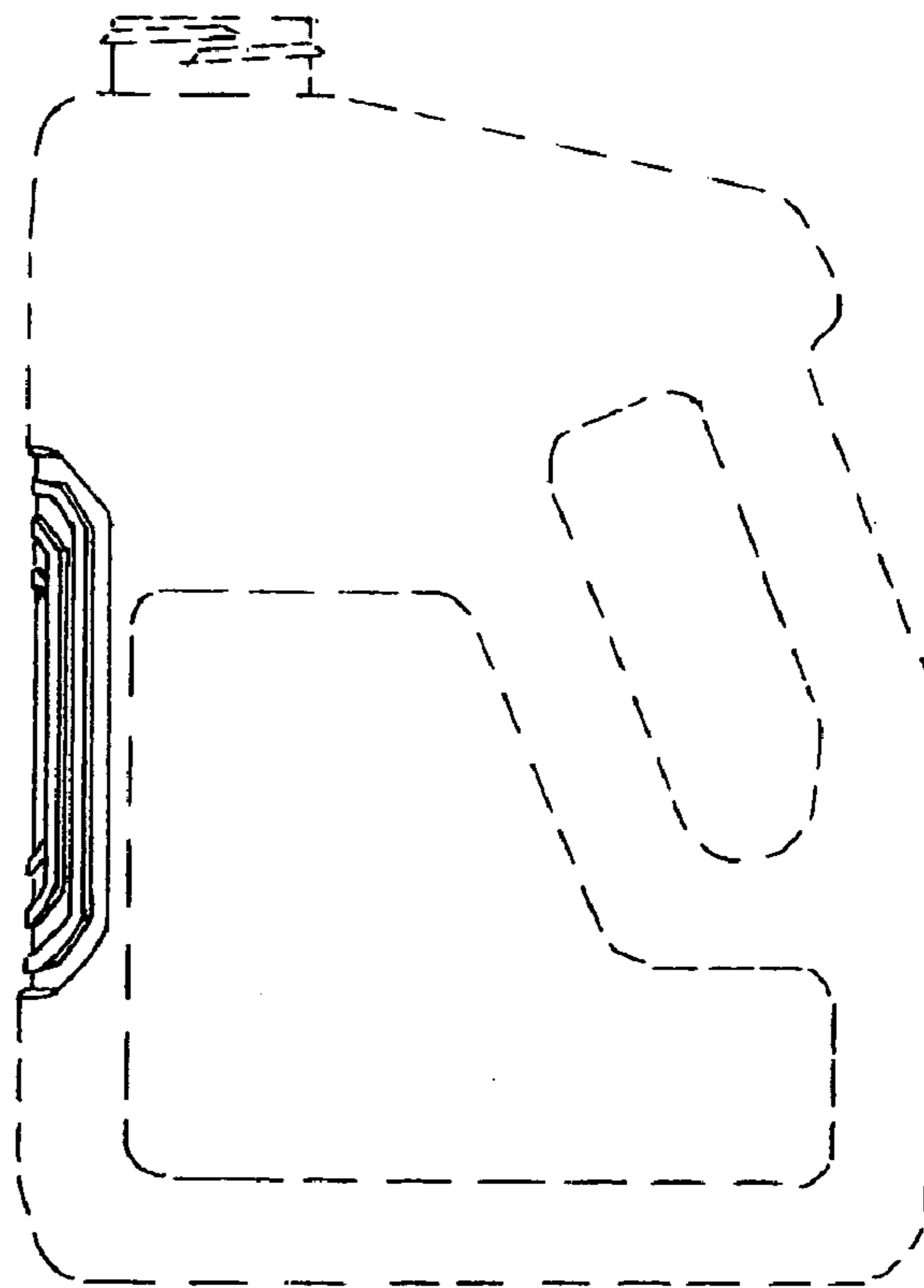
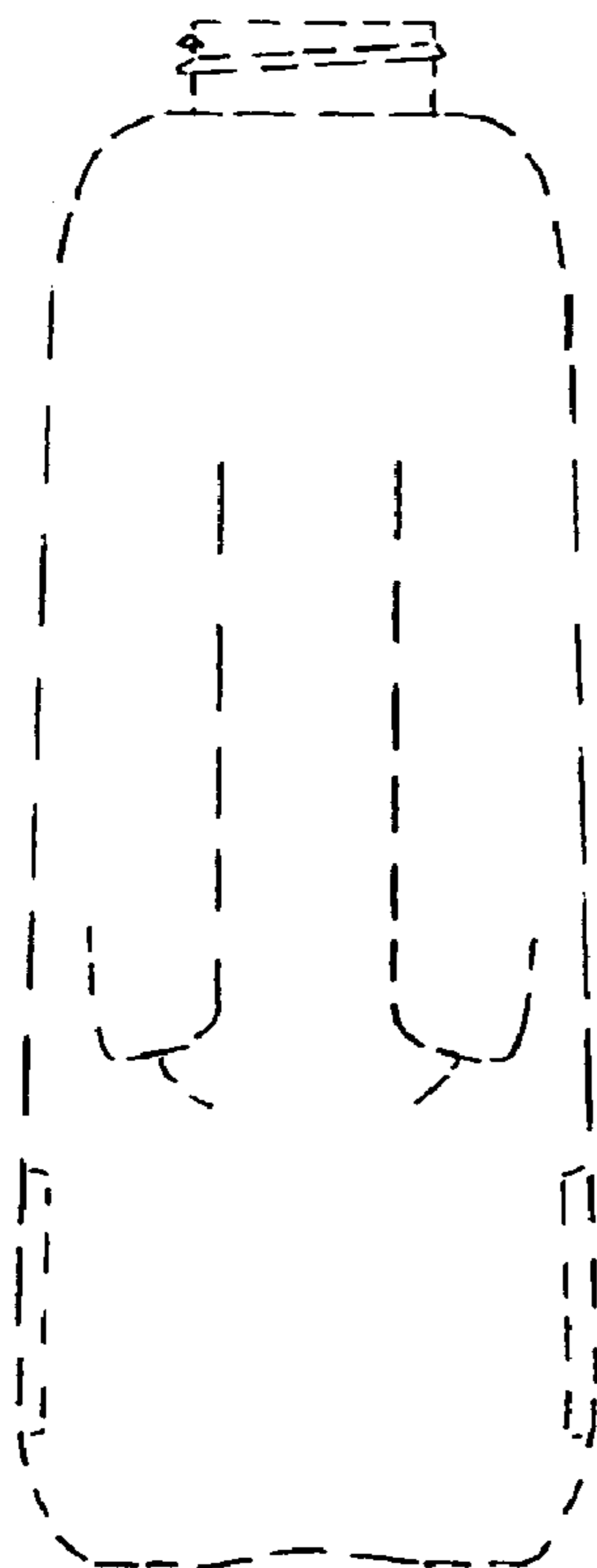

FIG. 10



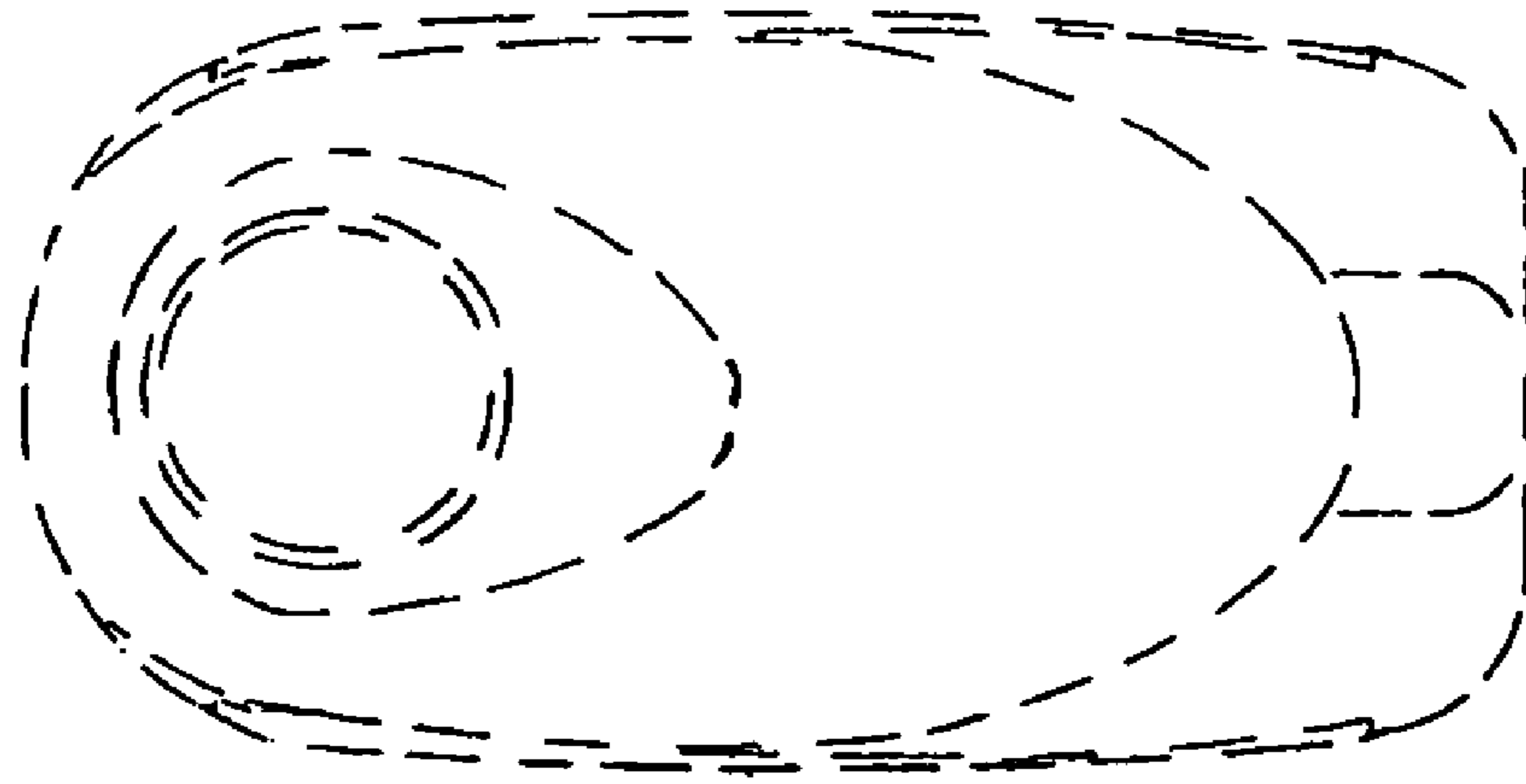

FIG. 11

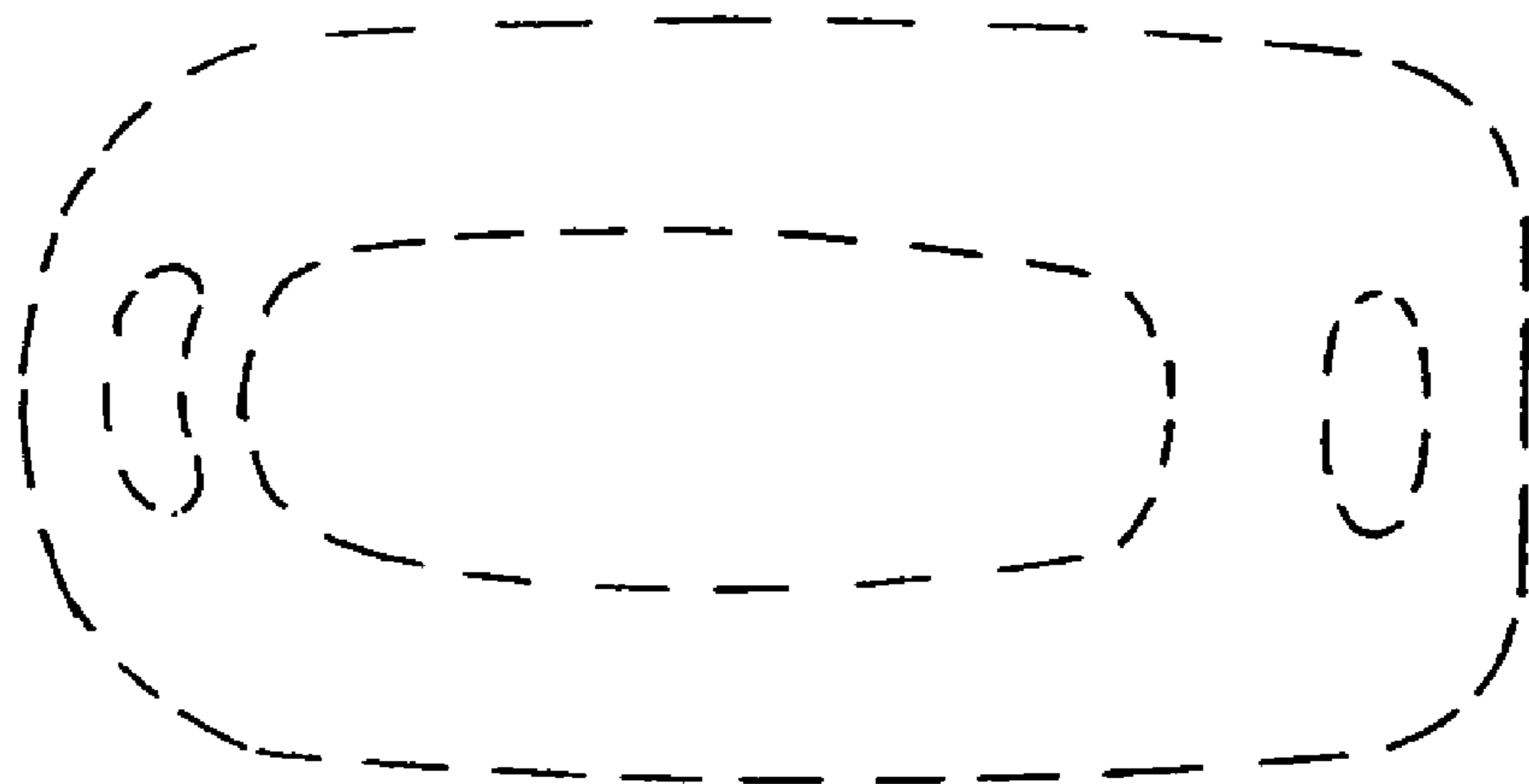

FIG. 12

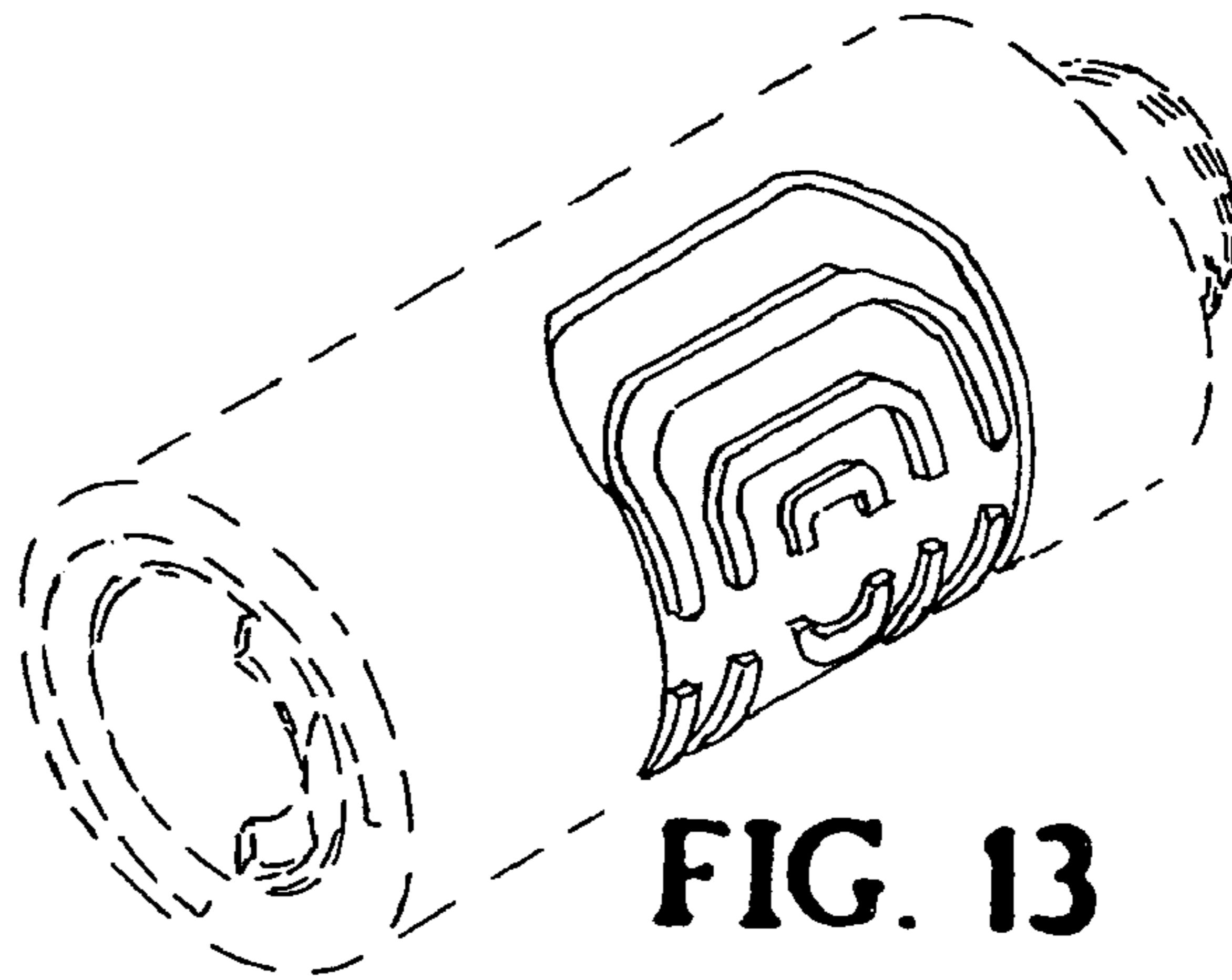

FIG. 13

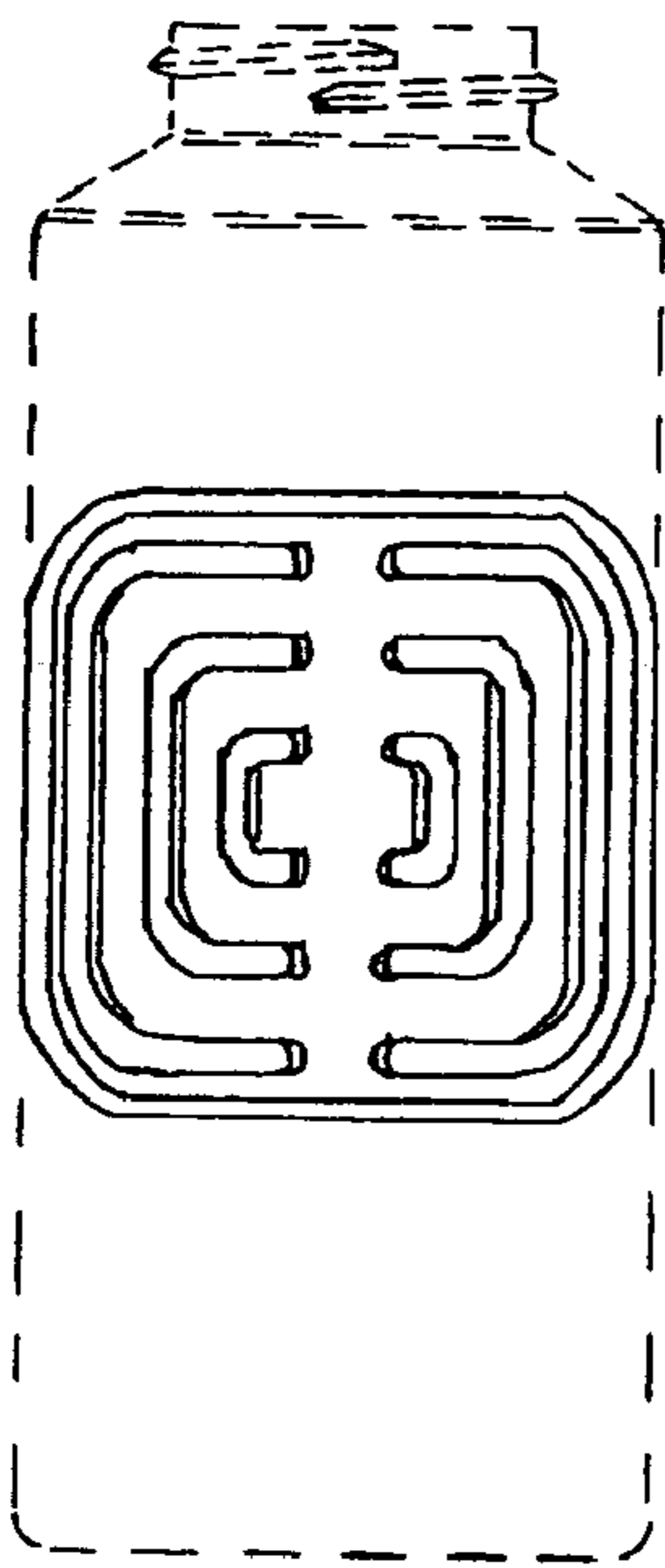

FIG. 14

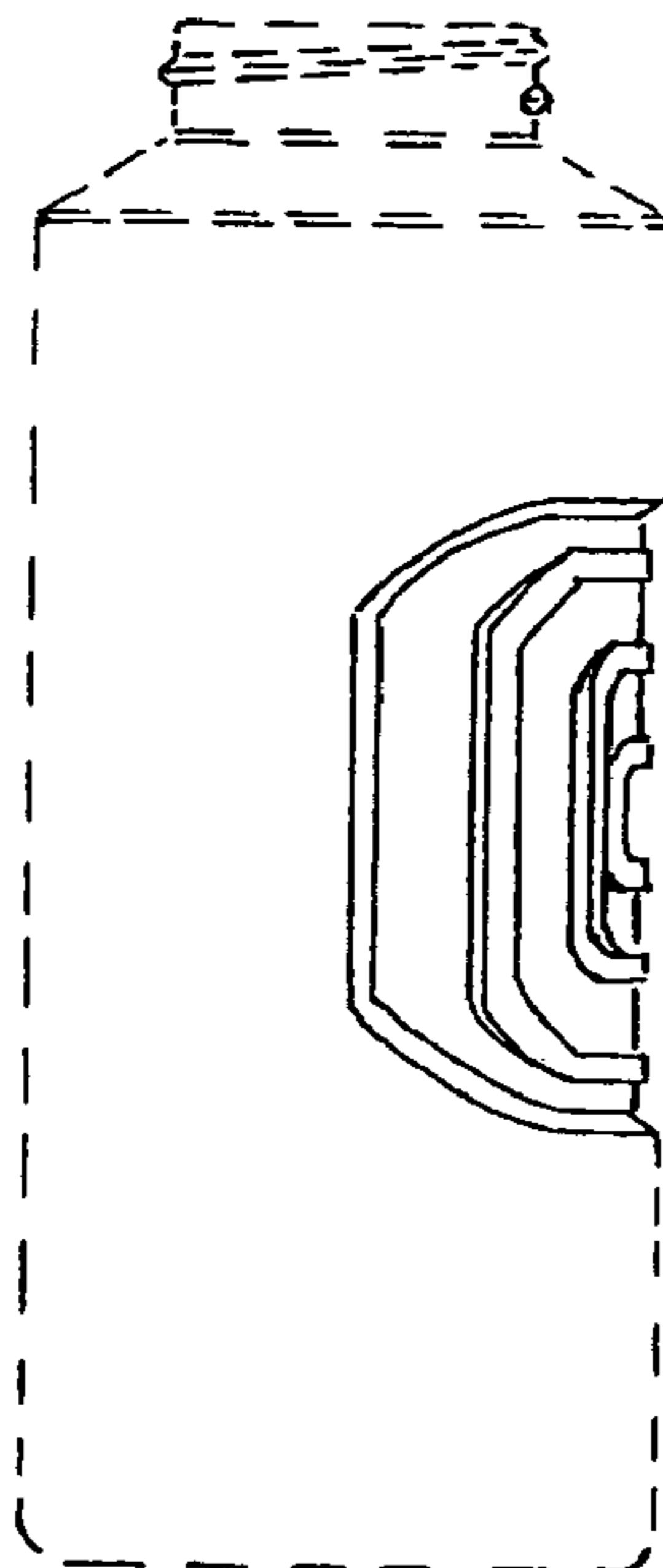

FIG. 15

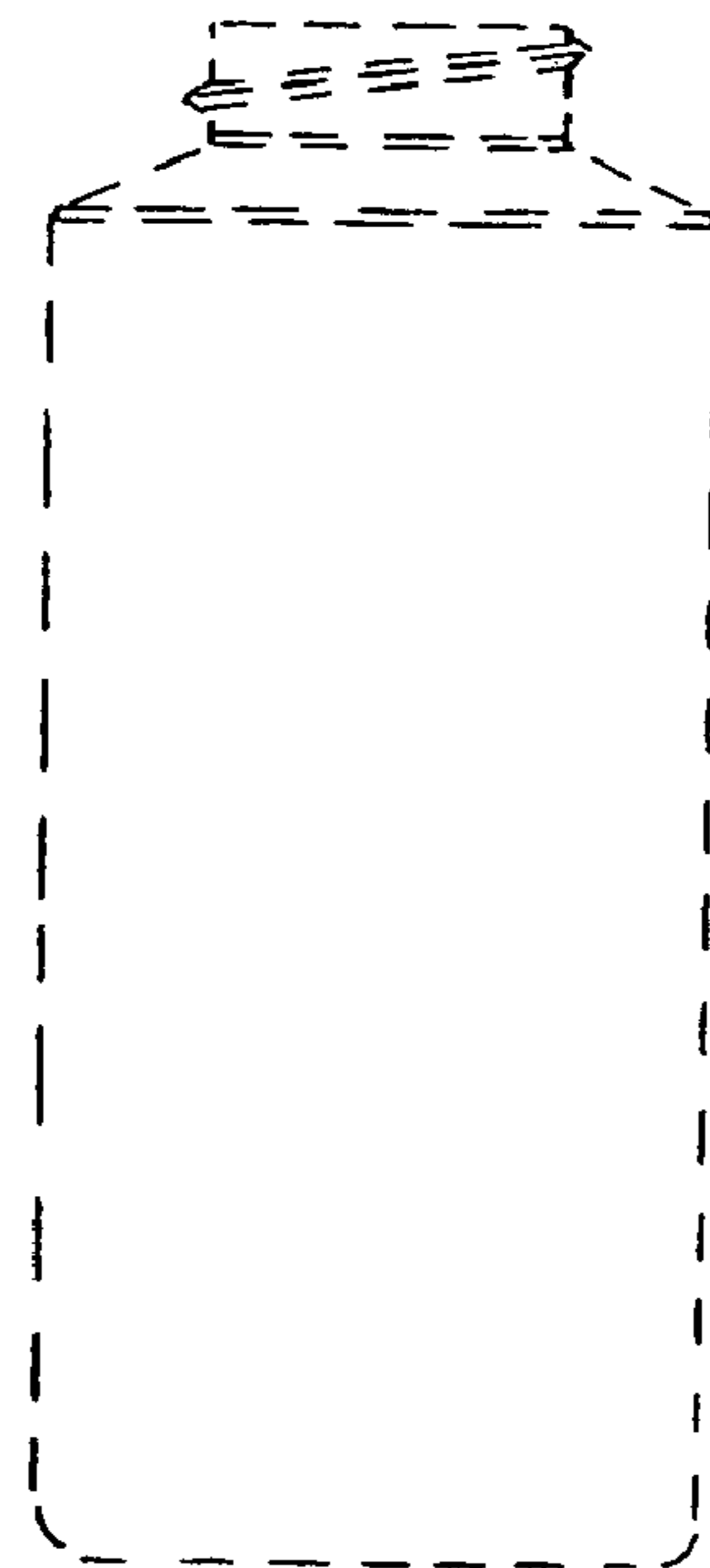

FIG. 16

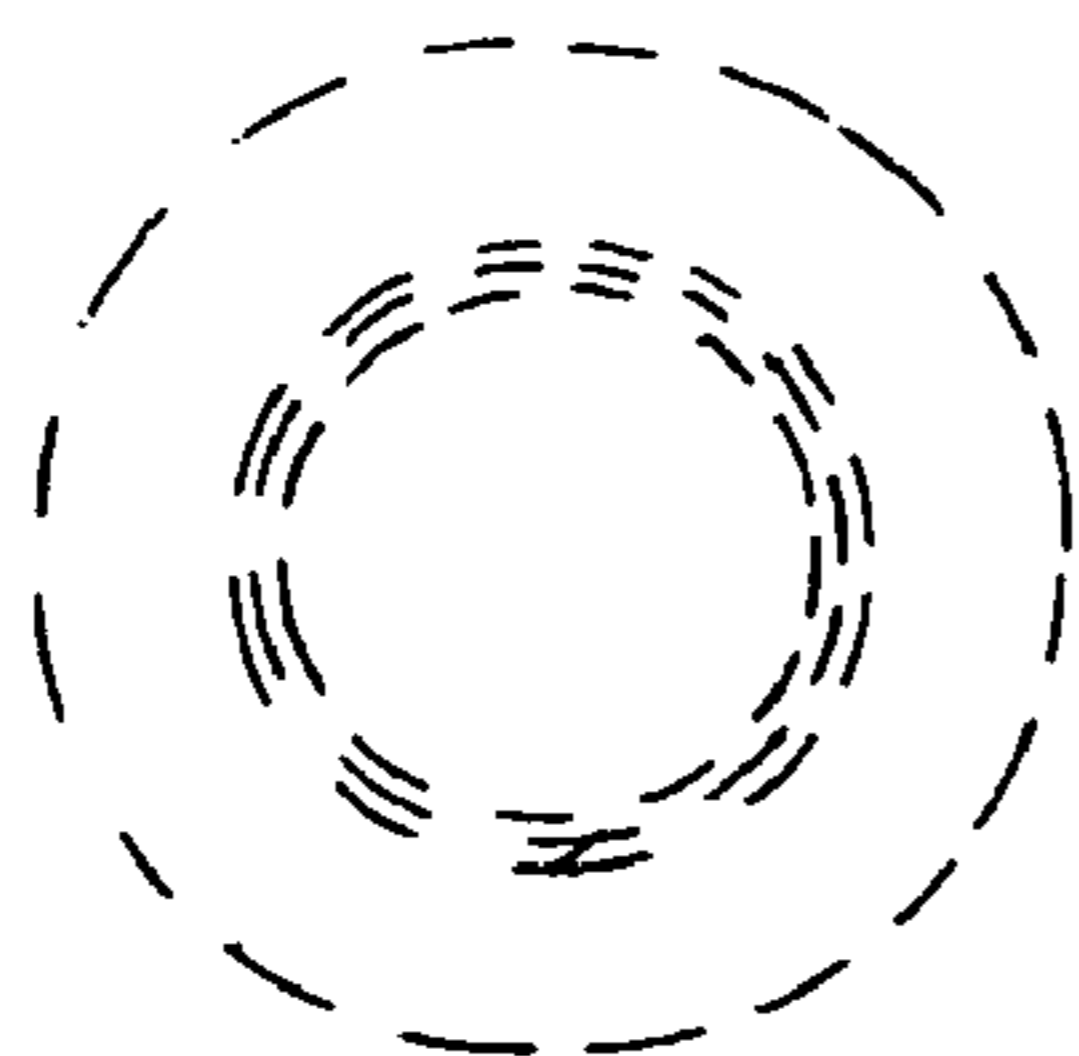

FIG. 17

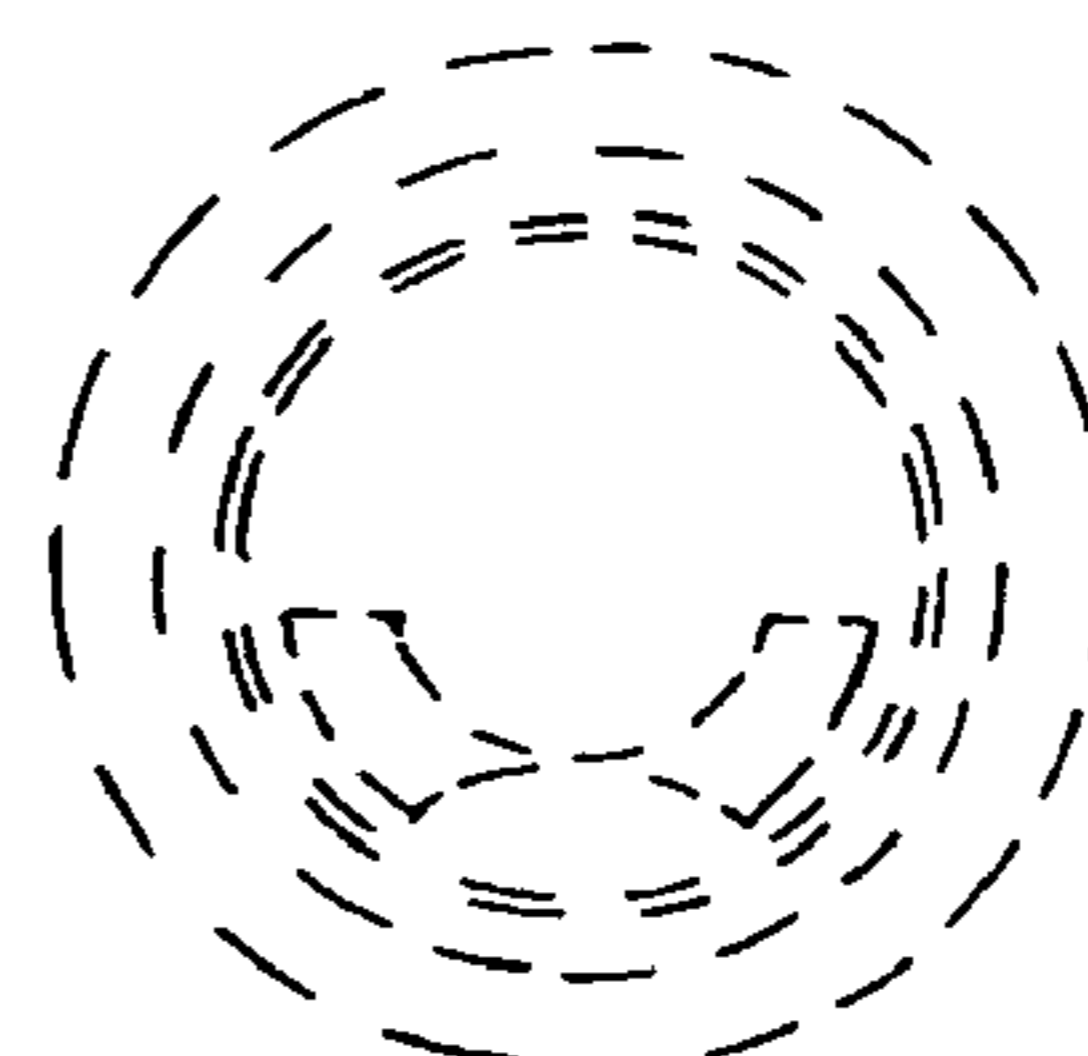

FIG. 18

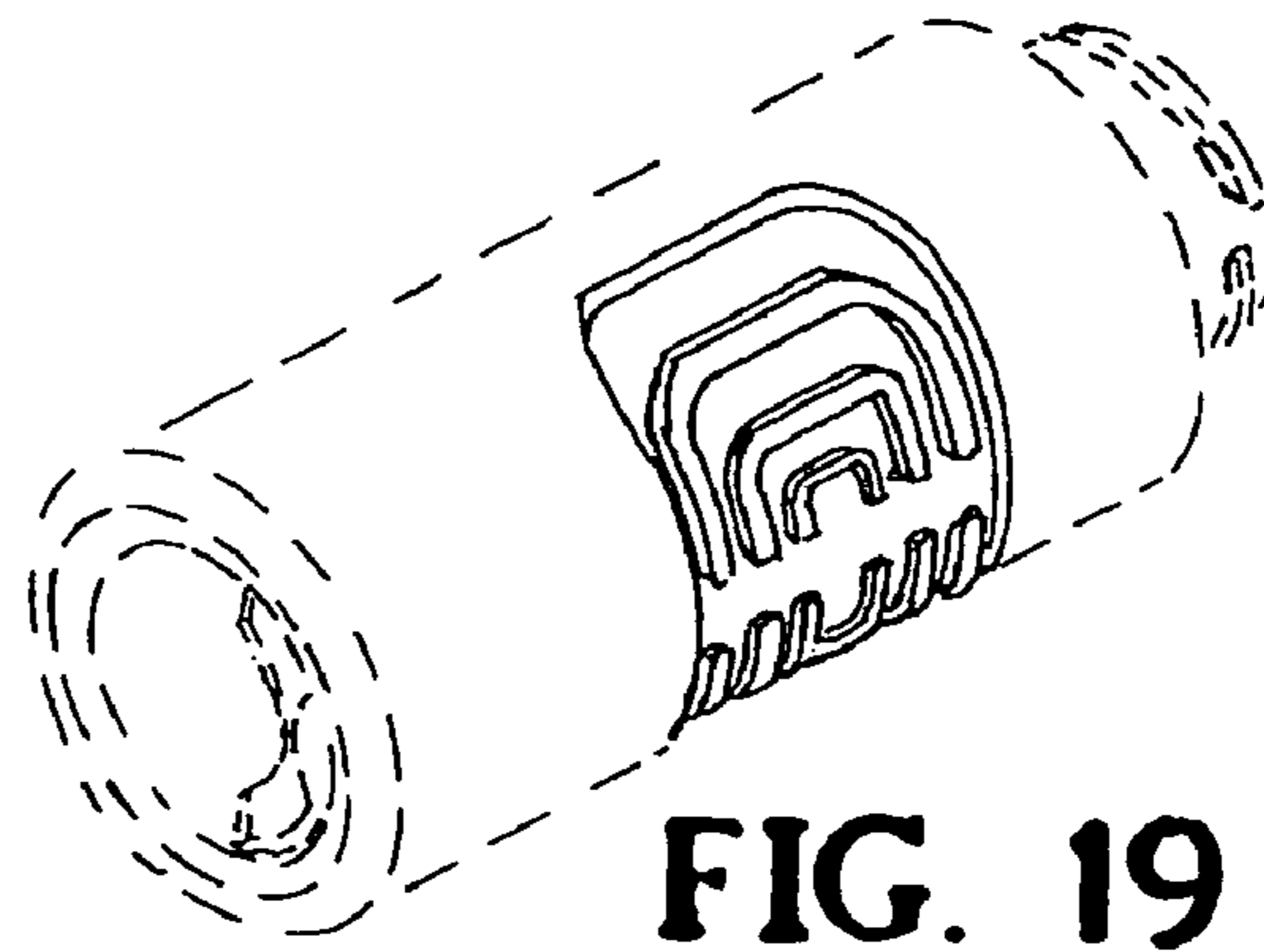

FIG. 19

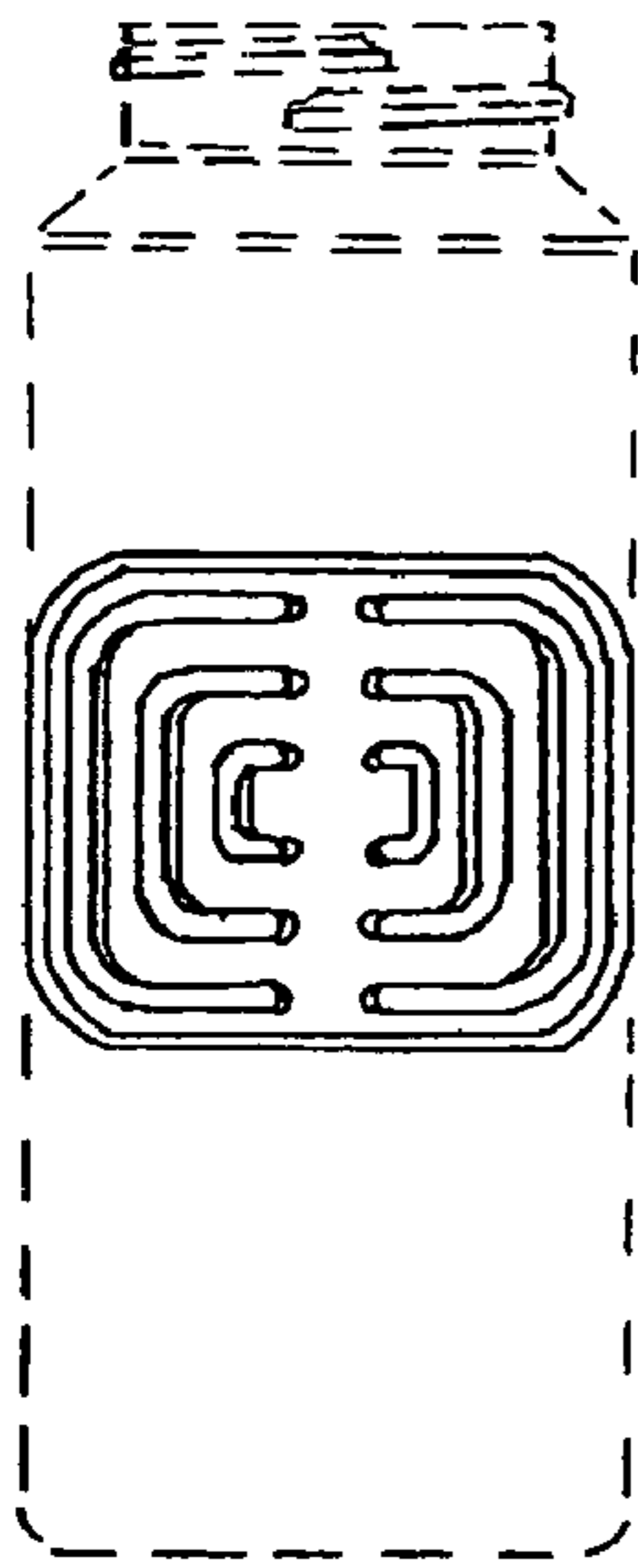

FIG. 20

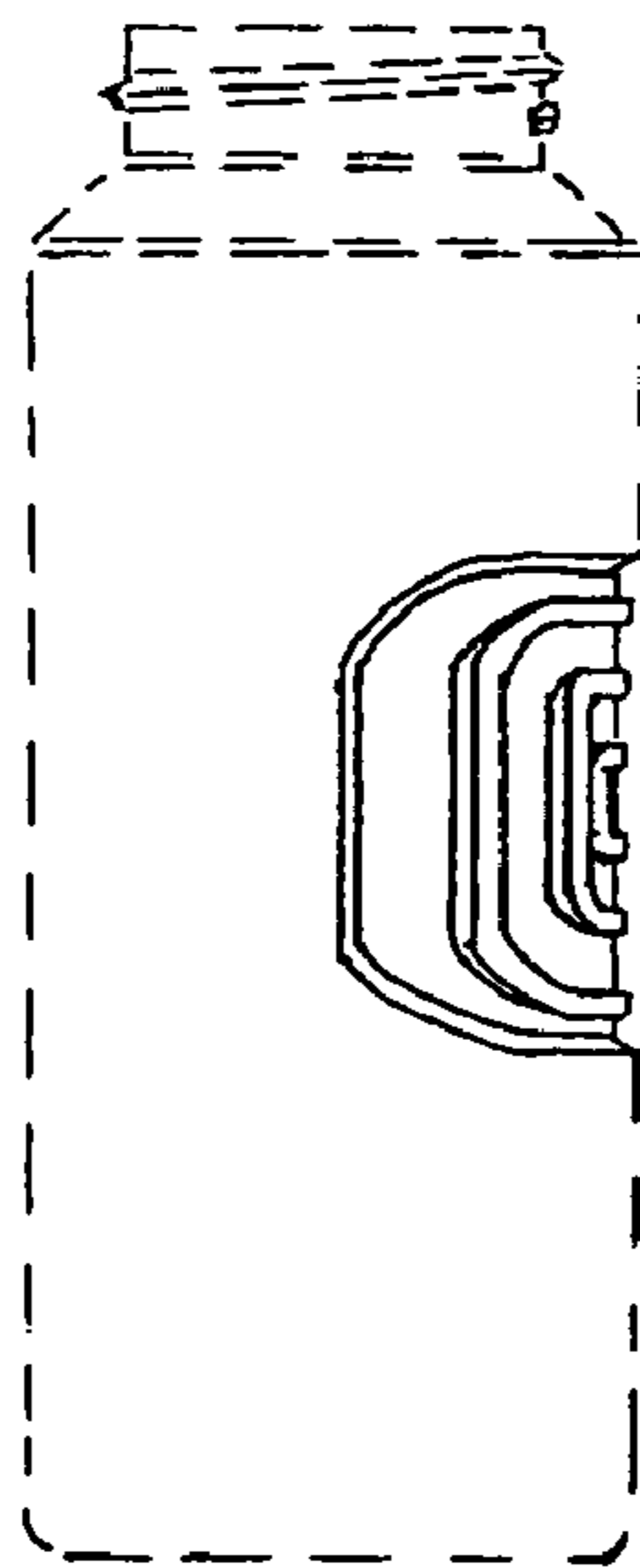

FIG. 21

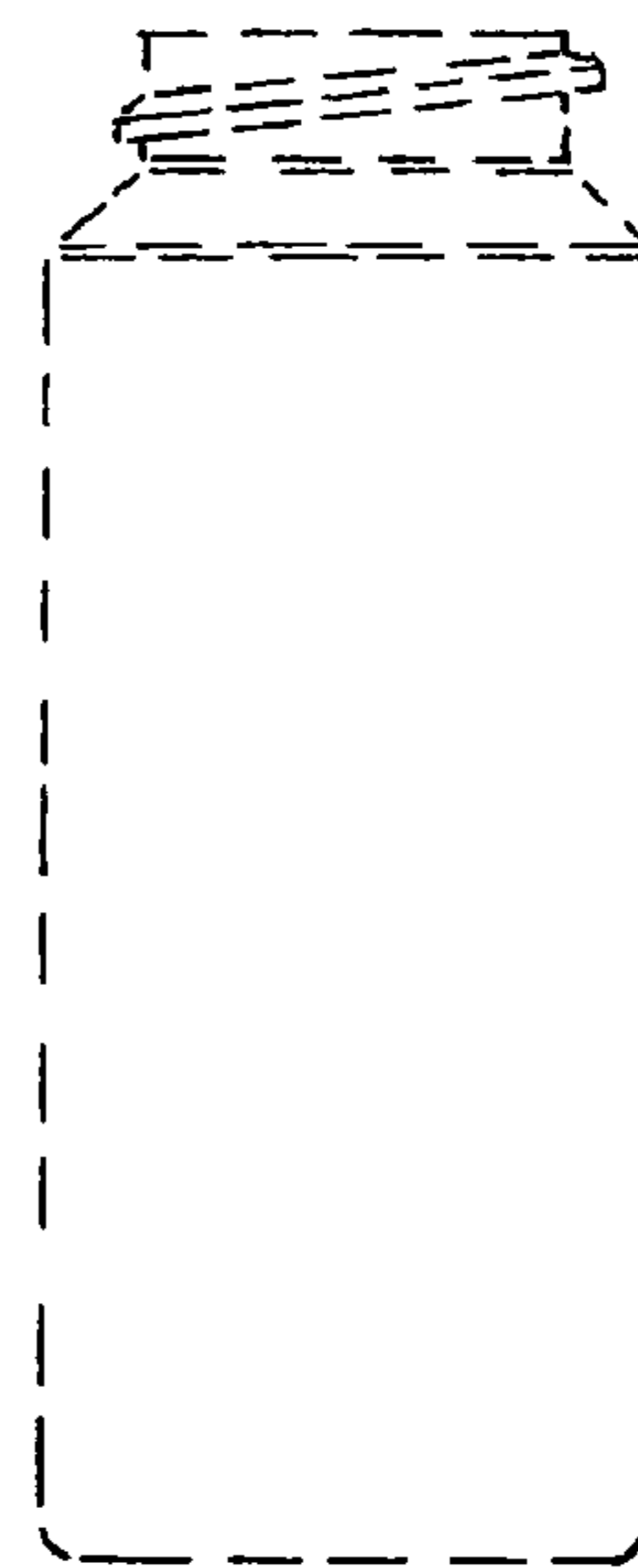

FIG. 22

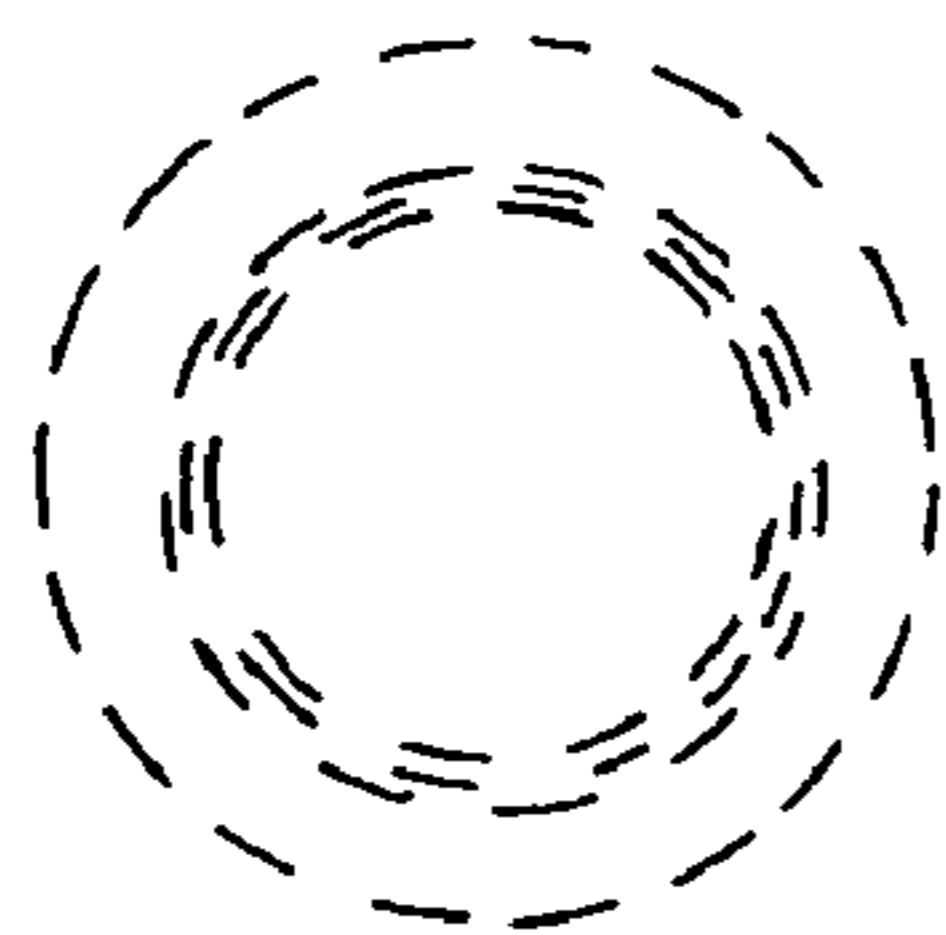

FIG. 23

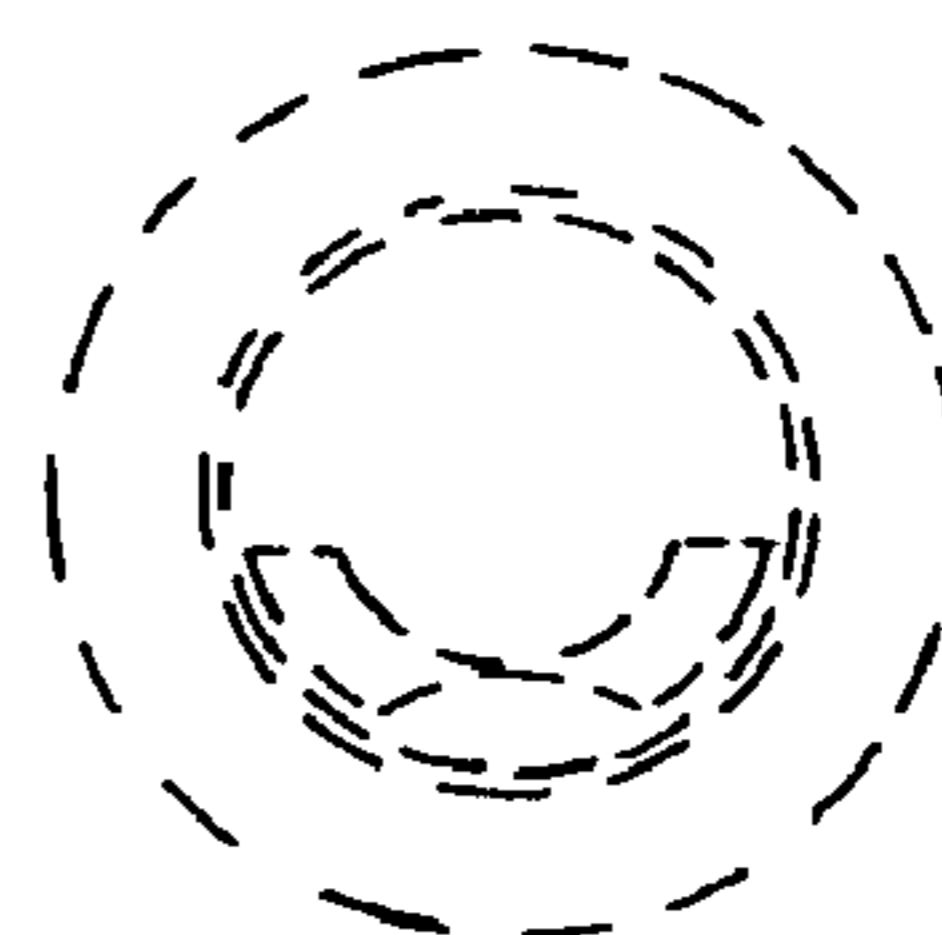

FIG. 24