

US00D544279S

(12) **United States Design Patent**
Kivett et al.

(10) **Patent No.:** **US D544,279 S**
(45) **Date of Patent:** **** Jun. 12, 2007**

(54) **GEAR SHIFT COAT HANGER**

(75) Inventors: **Joel Kivett**, Lawrence, KS (US); **Geoff Tolsdorf**, St. Louis, MO (US)

(73) Assignee: **Schroeder & Tremayne, Inc.**, St. Louis, MO (US)

(**) Term: **14 Years**

(21) Appl. No.: **29/232,477**

(22) Filed: **Jun. 20, 2005**

(51) **LOC (8) Cl.** **06-04**

(52) **U.S. Cl.** **D6/569; D8/372**

(58) **Field of Classification Search** D6/553,
D6/567, 569, 572, 546, 315, 323; 211/13.1,
211/30, 85.2, 32, 85.3, 70.6, 86.01, 87.01,
211/106.01; 309/301, 309.1, 304, 309.2;
D8/367, 372

See application file for complete search history.

(56) **References Cited**

U.S. PATENT DOCUMENTS

D302,918 S *	8/1989	Maki	D6/569
D324,314 S *	3/1992	Licari et al.	D6/323
D423,339 S *	4/2000	Snell	D8/372
D486,380 S *	2/2004	McDaniel	D8/372

* cited by examiner

Primary Examiner—Brian N Vinson
(74) *Attorney, Agent, or Firm*—Thompson Coburn LLP

(57) **CLAIM**

The ornamental design for a gear shift coat hanger, as shown and described.

DESCRIPTION

FIG. 1 is a perspective view of a gear shift coat hanger in accordance with one embodiment of the present invention; FIG. 2 is a top view of the gear shift coat hanger of FIG. 1; FIG. 3 is a left side view of the gear shift coat hanger of FIG. 1; FIG. 4 is a front view of the gear shift coat hanger of FIG. 1; FIG. 5 is a right side view of the gear shift coat hanger of FIG. 1; FIG. 6 is a bottom view of the gear shift coat hanger of FIG. 1; and, FIG. 7 is a back view of the gear shift coat hanger of FIG. 1.

It will be understood that the dashed lines presented in the drawings are for illustration only, and do not form a part of the claimed design.

1 Claim, 3 Drawing Sheets

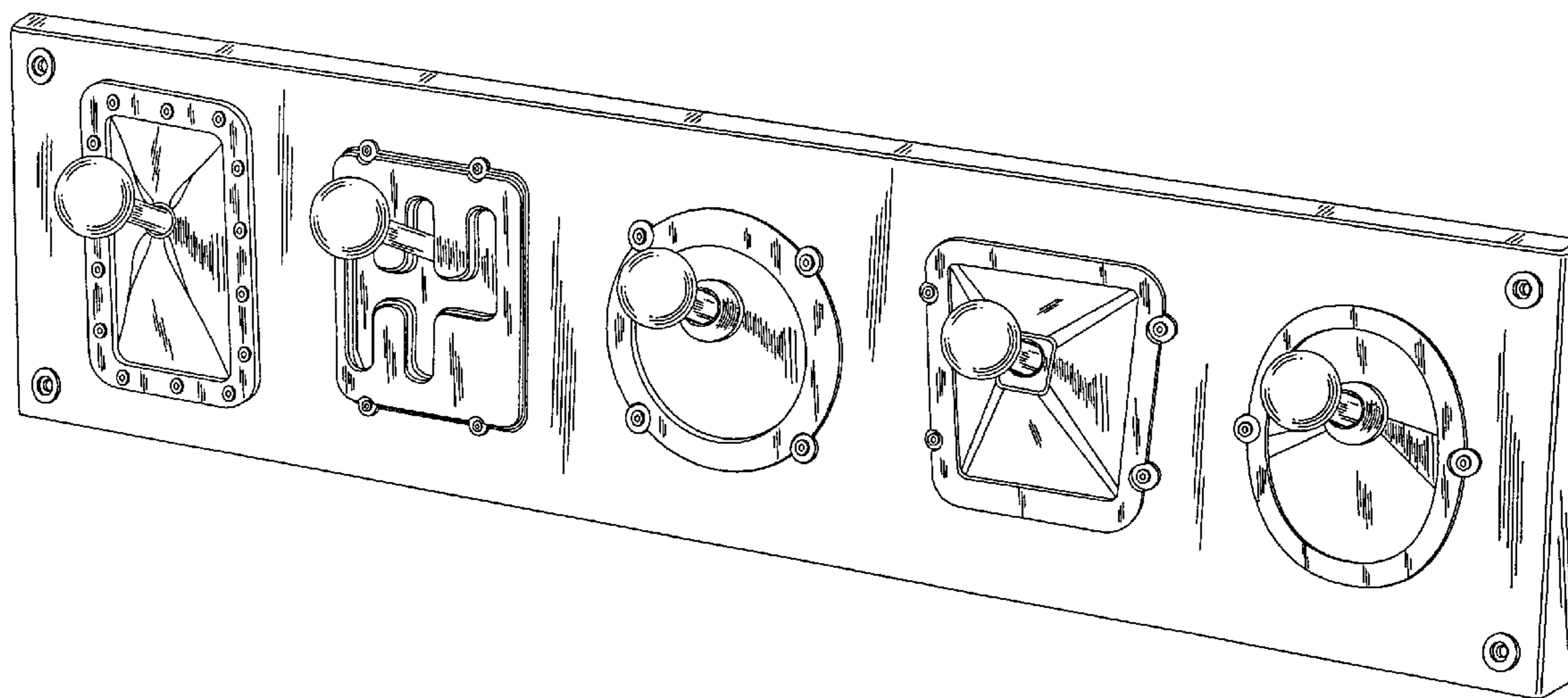

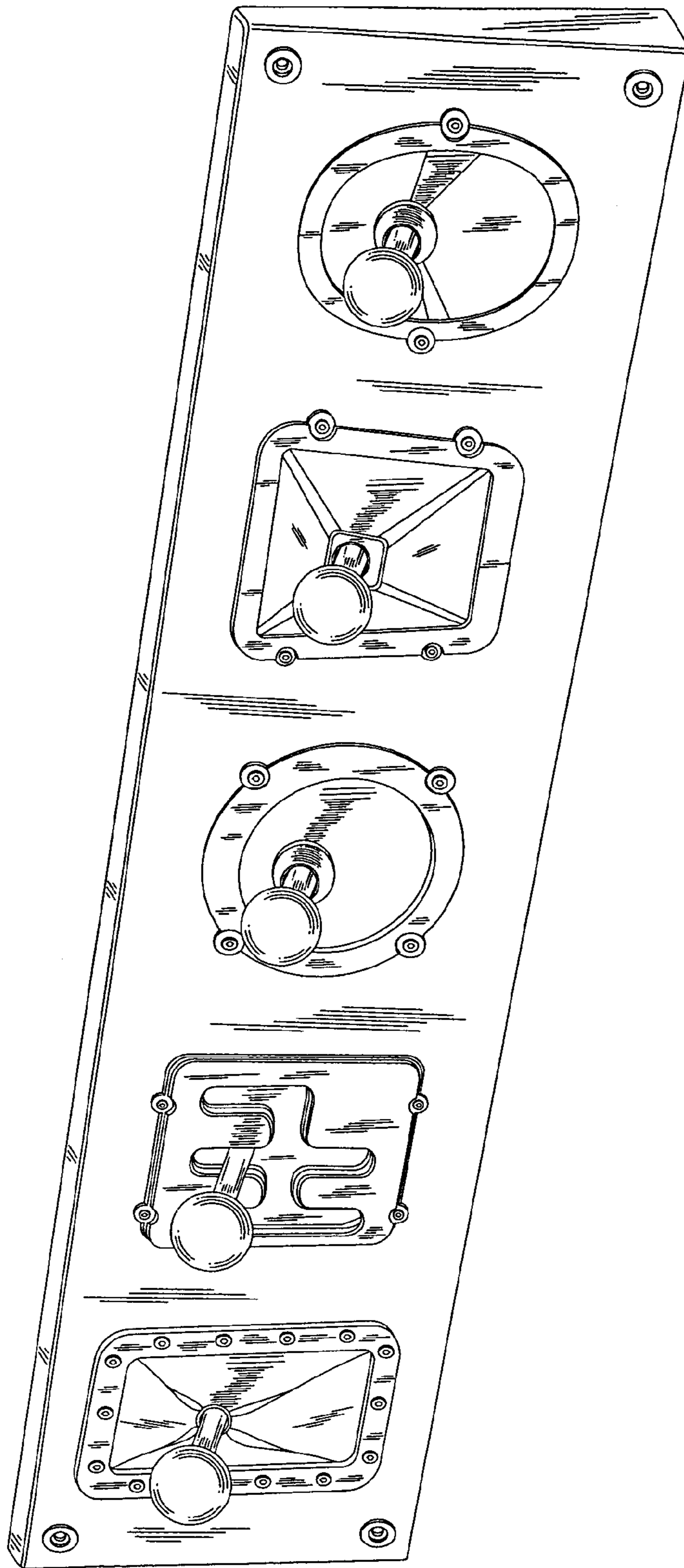

Figure 1

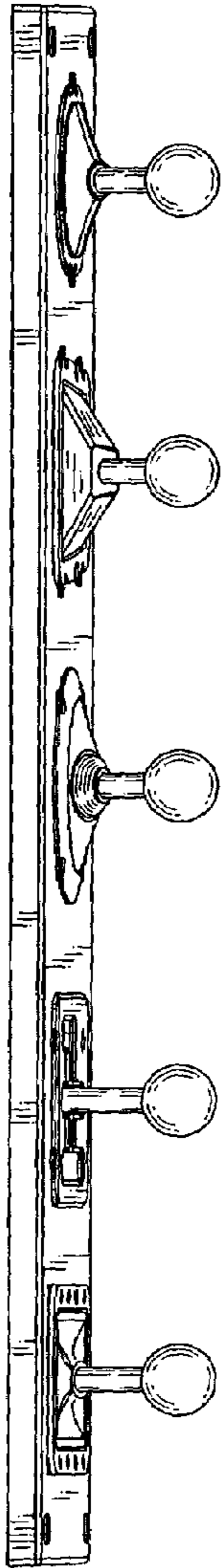

Figure 2

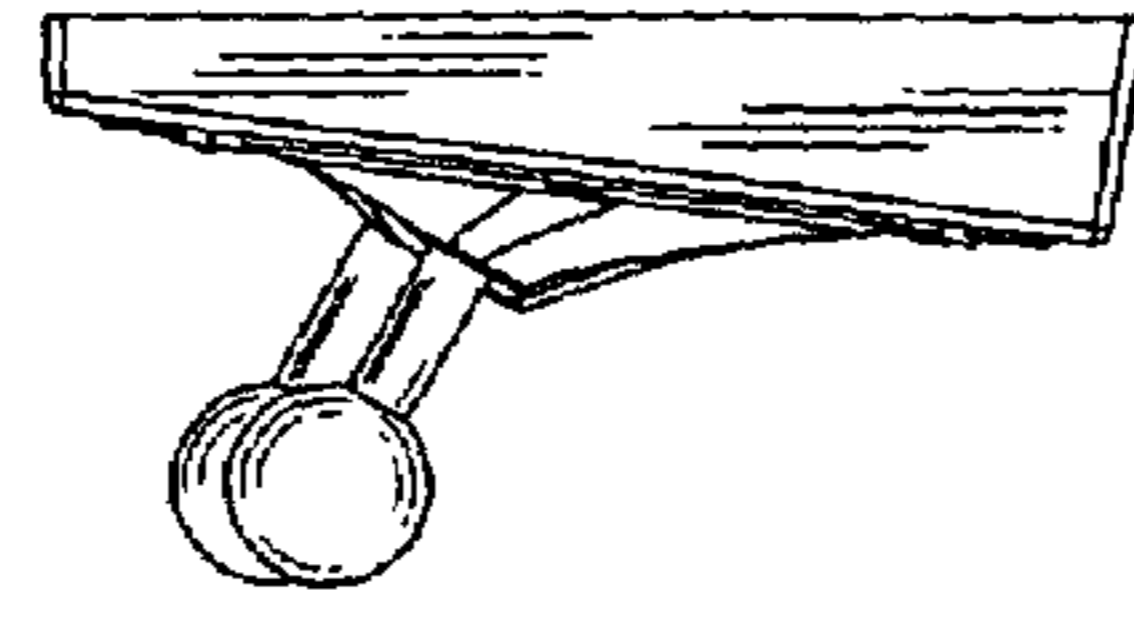

Figure 3

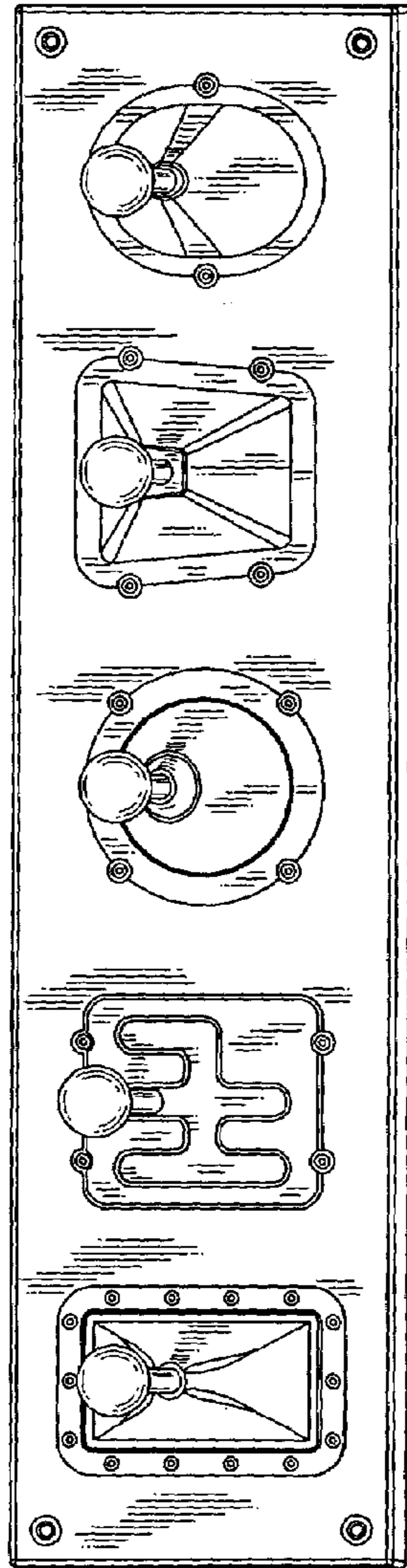

Figure 4

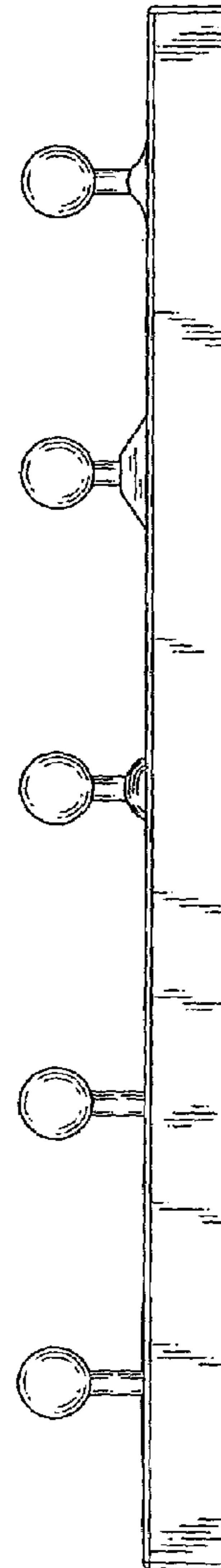

Figure 5

Figure 6

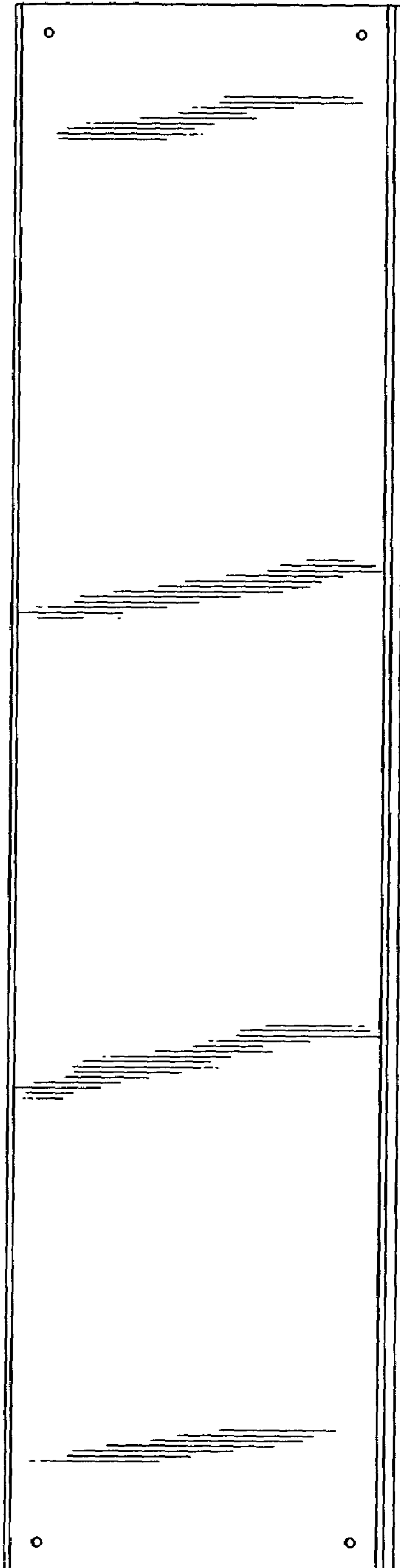

Figure 7