

US00D544260S

(12) **United States Design Patent**
Nawrocki

(10) **Patent No.:** **US D544,260 S**

(45) **Date of Patent:** **** Jun. 12, 2007**

(54) **SHELF FENCE COMPONENT**

(75) Inventor: **John Richard Nawrocki**, Ocala, FL
(US)

(73) Assignee: **Clairson, Inc.**, Newark, DE (US)

(**) Term: **14 Years**

(21) Appl. No.: **29/242,742**

(22) Filed: **Nov. 14, 2005**

(51) **LOC (8) Cl.** **06-06**

(52) **U.S. Cl.** **D6/511**

(58) **Field of Classification Search** D6/553,
D6/566, 567, 574, 511; 108/28-29; 248/235,
248/309.1; 211/13.1, 32, 41.3, 41.4, 86.01,
211/87.01, 90.01, 90.03, 126.9, 134, 181.1
See application file for complete search history.

(56) **References Cited**

U.S. PATENT DOCUMENTS

3,145,850	A	8/1964	Ciborowski	
3,608,741	A	9/1971	Schray	
3,827,574	A	8/1974	Craig, Sr.	
4,437,572	A	3/1984	Hoffman	
4,729,485	A	3/1988	Kulbersh	
4,917,248	A	4/1990	Friskney	
D349,000	S *	7/1994	Rogers et al.	D6/511
D352,195	S *	11/1994	Rogers et al.	D6/511
D354,864	S *	1/1995	Kokenge et al.	D6/511
5,405,026	A *	4/1995	Lee et al.	211/181.1
5,437,380	A	8/1995	Peay et al.	
5,836,461	A *	11/1998	Kokenge et al.	211/90.03
D419,344	S *	1/2000	Greene	D6/511
D427,466	S *	7/2000	Remmers	D6/511
D437,515	S *	2/2001	Remmers et al.	D6/511
6,341,704	B1	1/2002	Michel, Jr.	
7,004,335	B2 *	2/2006	Remmers	211/90.03
D527,559	S *	9/2006	Remmers	D6/511
D527,935	S *	9/2006	Remmers	D6/511

* cited by examiner

Primary Examiner—Brian N Vinson

(74) *Attorney, Agent, or Firm*—Harness, Dickey & Pierce, P.L.C.

(57) **CLAIM**

The ornamental design for a shelf fence component, as shown and described.

DESCRIPTION

FIG. 1 is a perspective view of a shelf fence component, showing my new design;

FIG. 2 is a back perspective view of the shelf fence component shown in FIG. 1;

FIG. 3 is a right side elevation view of the shelf fence component shown in FIG. 1;

FIG. 4 is a left side elevation view of the shelf fence component shown in FIG. 1;

FIG. 5 is a front elevation view of the shelf fence component shown in FIG. 1;

FIG. 6 is a back elevation view of the shelf fence component shown in FIG. 1;

FIG. 7 is a top plan view of the shelf fence component shown in FIG. 1;

FIG. 8 is a bottom plan view of the shelf fence component shown in FIG. 1; and,

FIG. 9 is a perspective view showing an exemplary shelf fence including a plurality of the shelf fence components shown in FIGS. 1 through 8 attached to an exemplary wire shelf.

The details shown in broken lines are for illustrative purposes only and form no part of the claimed design. In FIGS. 1 through 6, the separation and bracket are used to indicate indeterminate length, as the shelf fence component can be shorter or longer than shown in the figures.

1 Claim, 2 Drawing Sheets

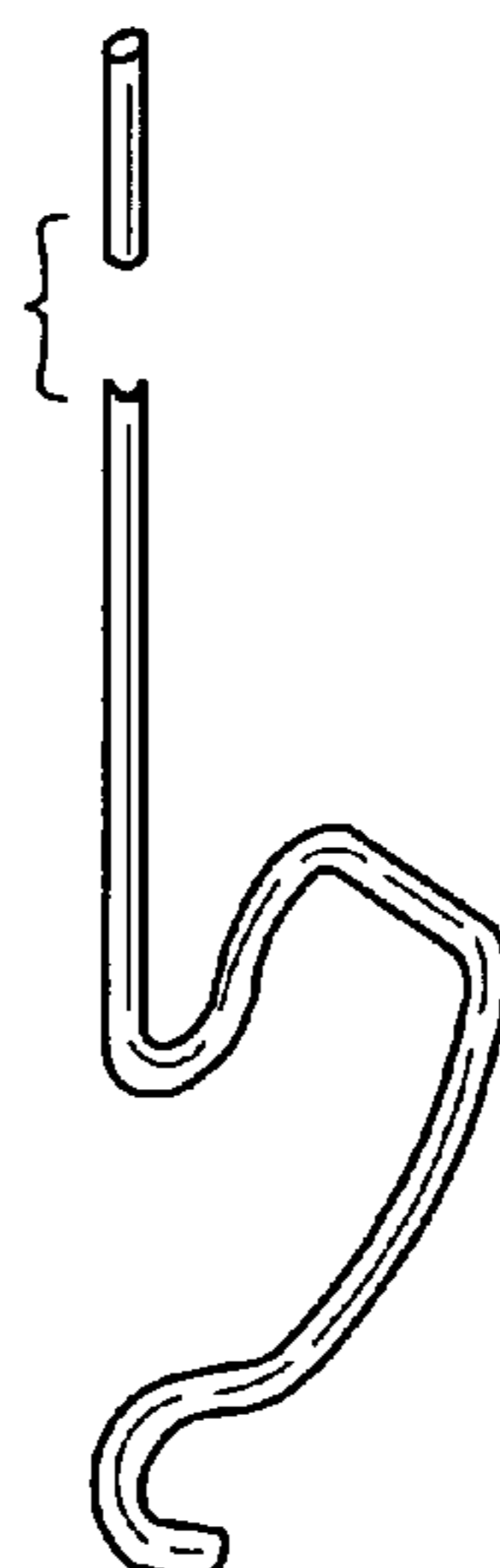

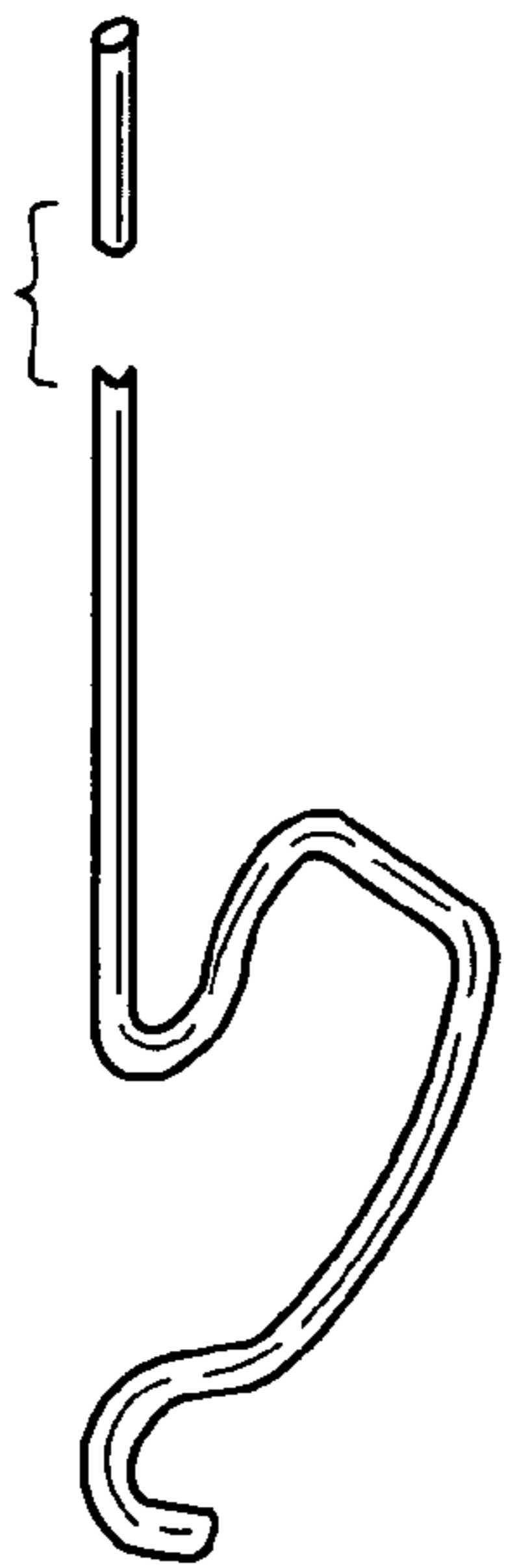

FIG. 1

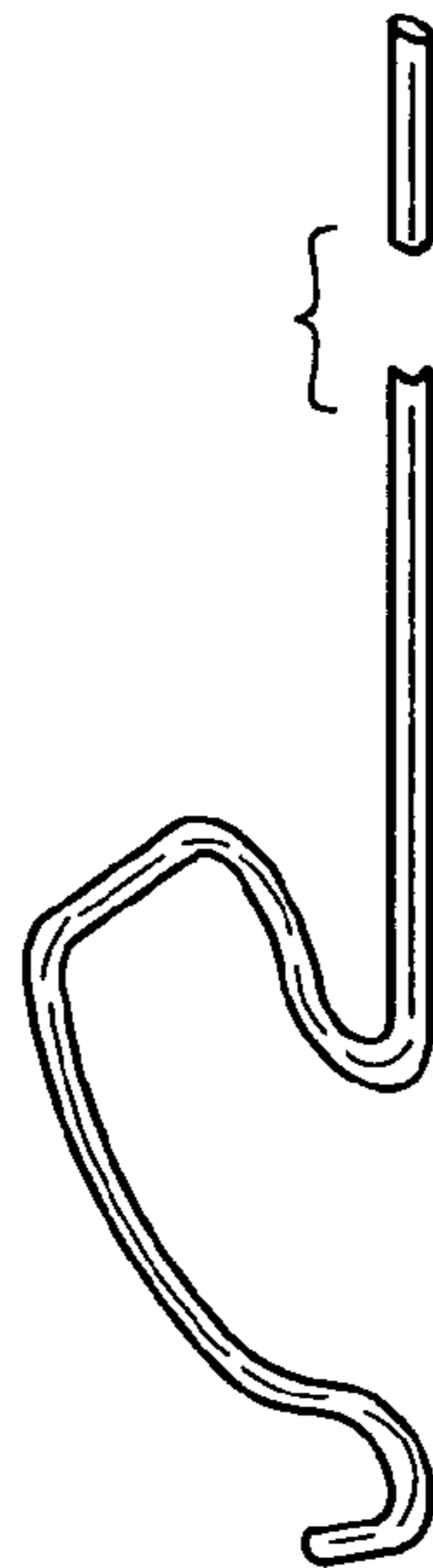

FIG. 2

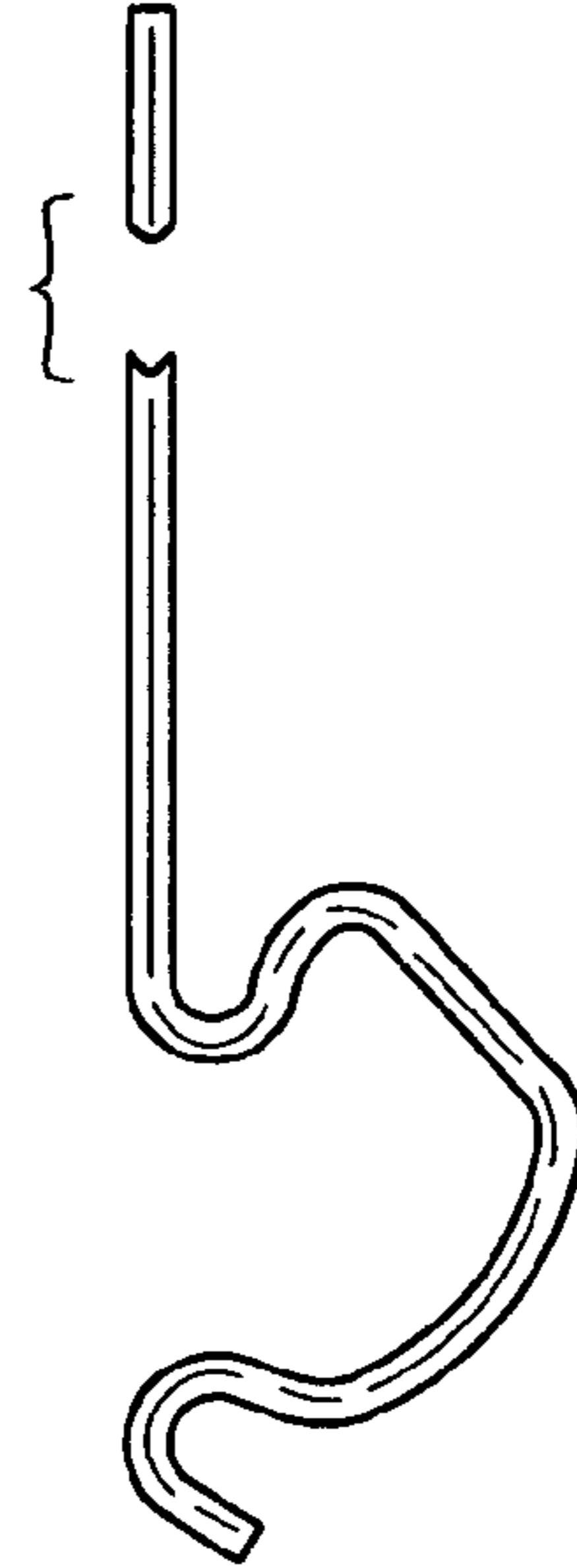

FIG. 3

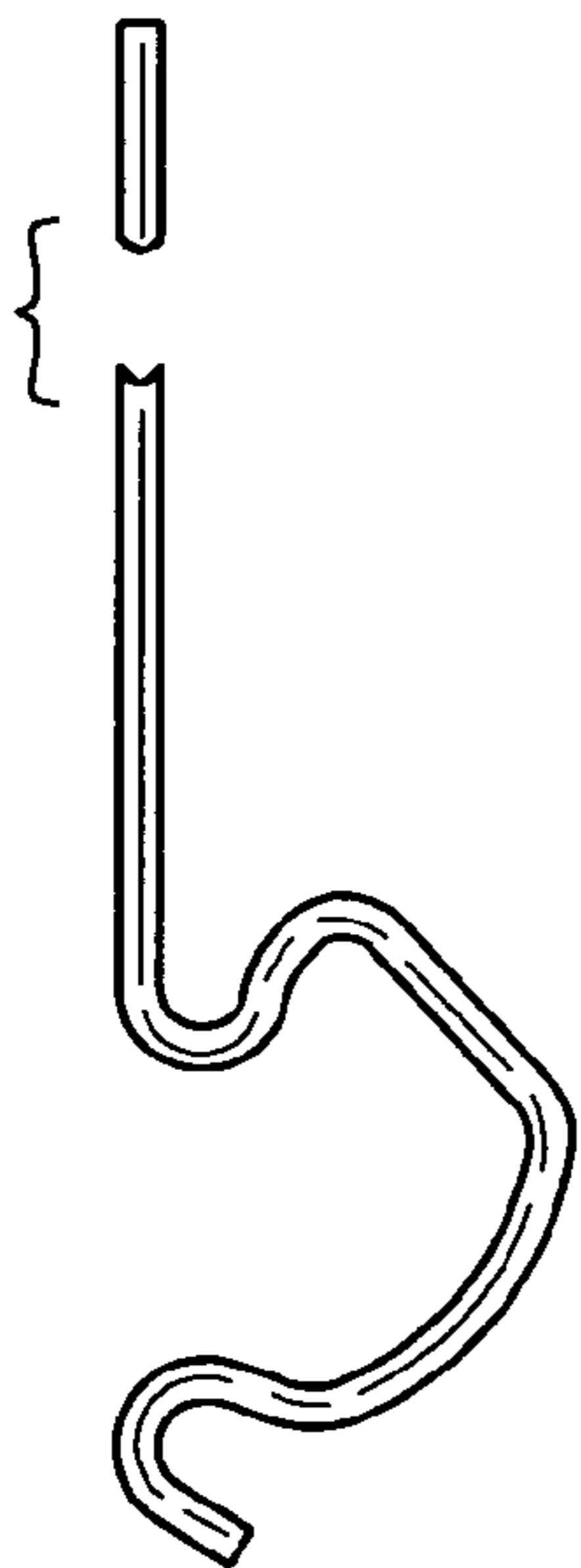

FIG. 4

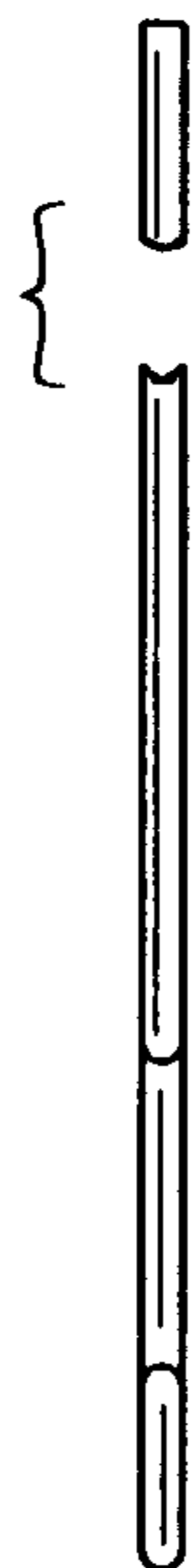

FIG. 5



FIG. 6

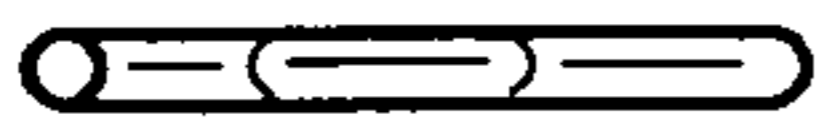

FIG. 7



FIG. 8

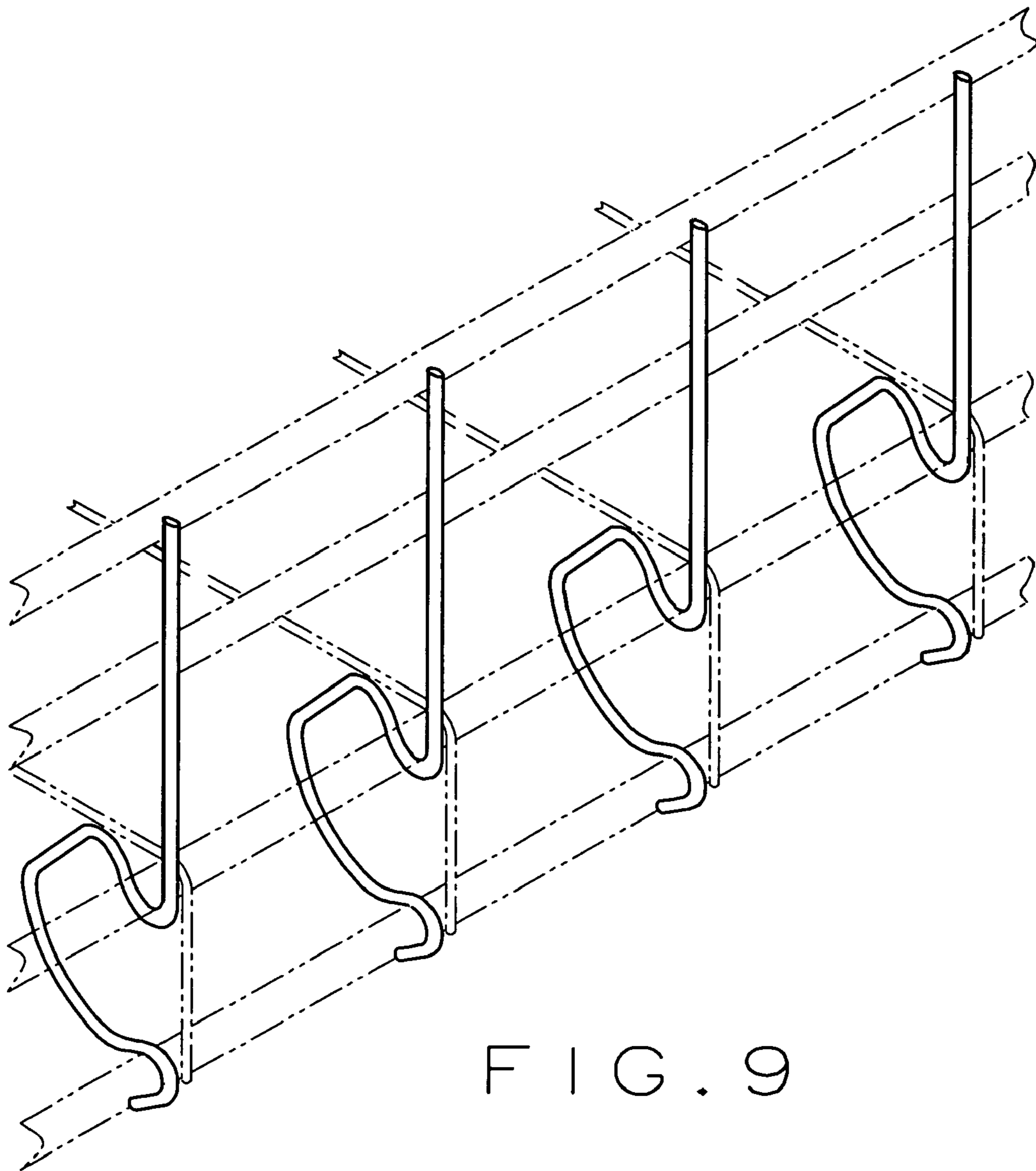

FIG. 9