

US00D544223S

(12) **United States Design Patent**
Bongiorno

(10) **Patent No.:** **US D544,223 S**

(45) **Date of Patent:** **** Jun. 12, 2007**

(54) **CHAIR FRAME**

5,851,052 A * 12/1998 Gustafsson 297/16.2
5,954,391 A * 9/1999 Gray 297/58

(76) Inventor: **Steven James Bongiorno**, 255
Southside Ave., Freeport, NY (US)
11520

* cited by examiner

Primary Examiner—Mimosa De

(**) Term: **14 Years**

(57) **CLAIM**

(21) Appl. No.: **29/268,797**

The ornamental design for a chair frame, as shown and described.

(22) Filed: **Nov. 13, 2006**

(51) **LOC (8) Cl.** **06-01**

(52) **U.S. Cl.** **D6/363**

(58) **Field of Classification Search** D6/334–336,
D6/363, 364, 365, 368, 374, 375, 379, 380,
D6/500–502; 297/16.1, 16.2, 58, 129, 451.2
See application file for complete search history.

DESCRIPTION

FIG. 1 is a front, left side perspective view of a chair frame comprising my new design;

FIG. 2 is a left-side perspective view thereof;

FIG. 3 is a front-elevation view thereof;

FIG. 4 is a rear-elevation view thereof;

FIG. 5 is a side-elevation view, the opposite side elevation view being a mirror image thereof; and,

FIG. 6 is a top-plan view thereof.

The dashed lines depicting the chair seat and backrest in FIG. 1 have been shown for illustrative purposes only and form no part of the claimed design.

(56) **References Cited**

U.S. PATENT DOCUMENTS

D73,275 S *	8/1927	Adler	D6/363
D169,908 S *	6/1953	Merit et al.	D6/375
D182,245 S *	3/1958	Rabin	D6/363
D183,478 S *	9/1958	Cohen	D6/363
D261,332 S *	10/1981	Rohr	D6/363
5,332,283 A *	7/1994	Gray	297/58
D396,569 S *	8/1998	Chen	D6/368

1 Claim, 6 Drawing Sheets

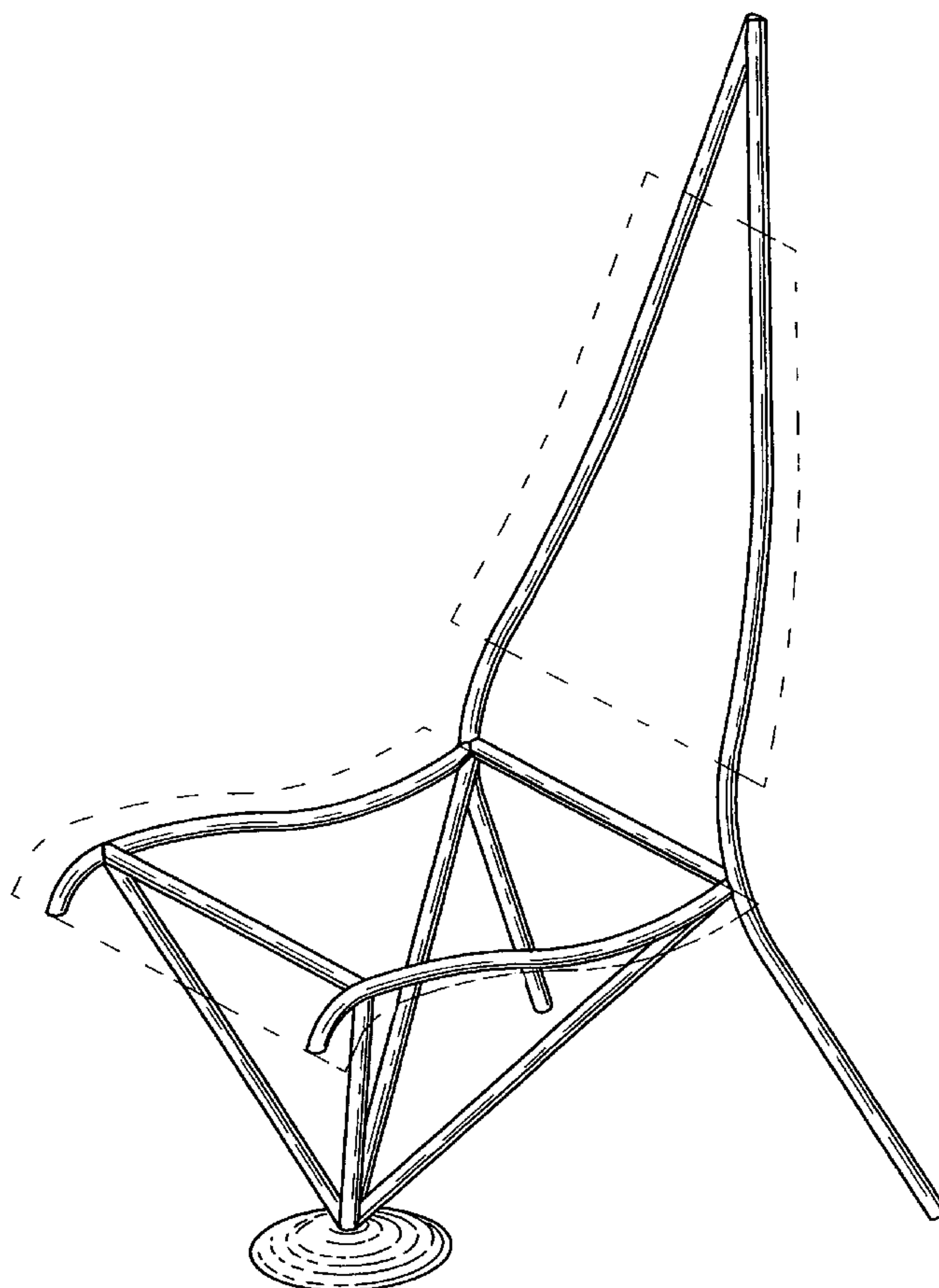

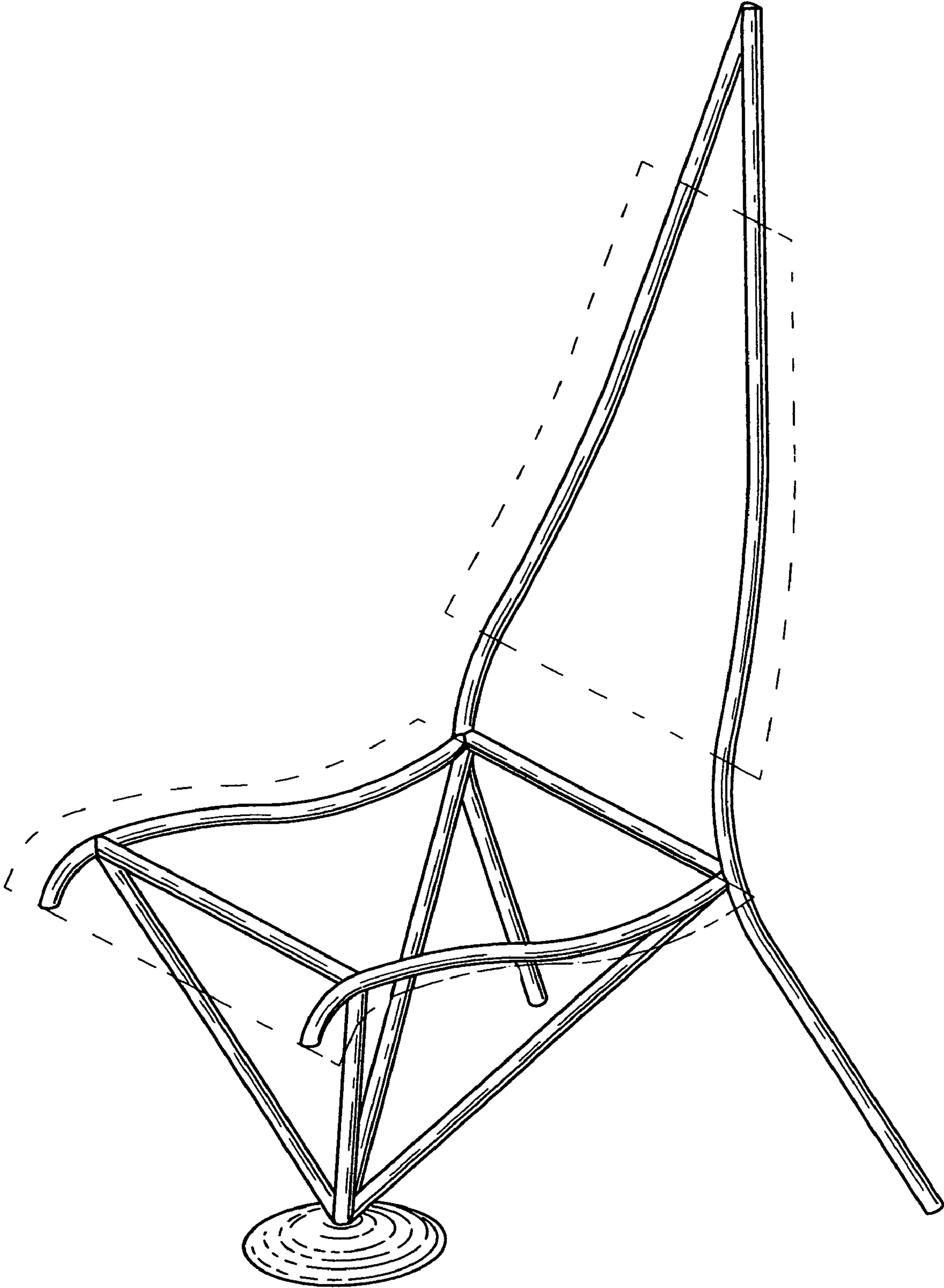

FIG. 1

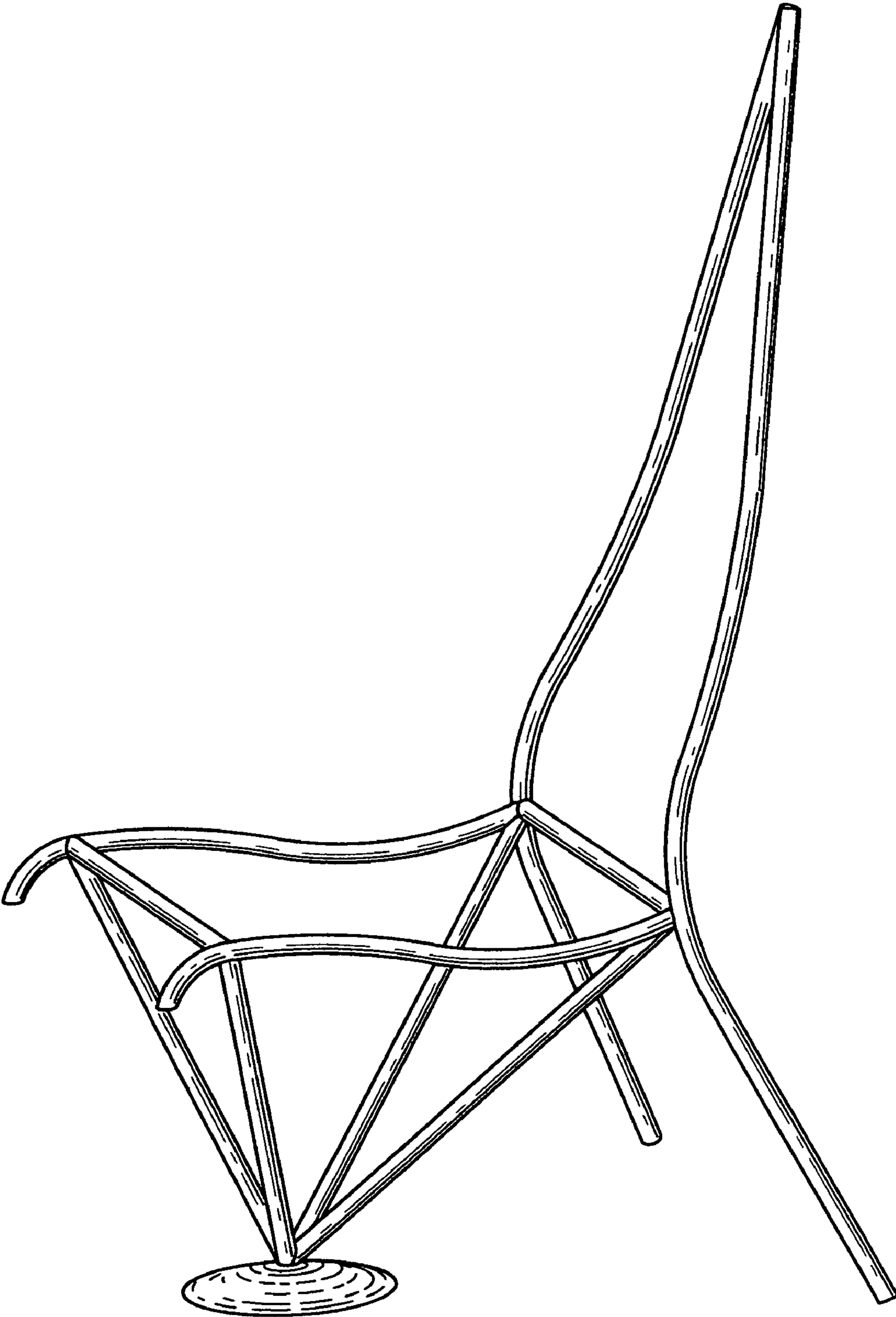

FIG. 2

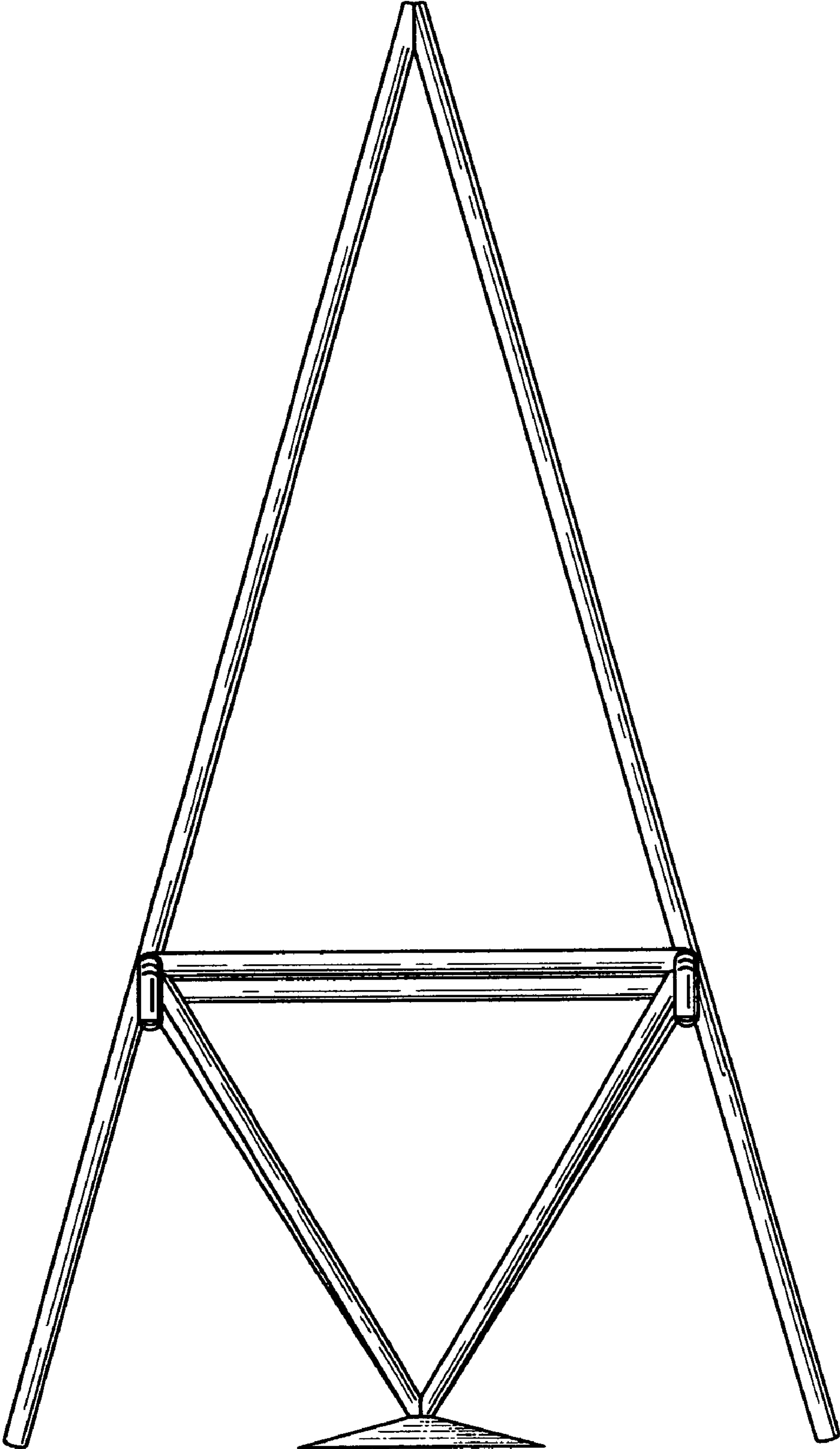

FIG. 3

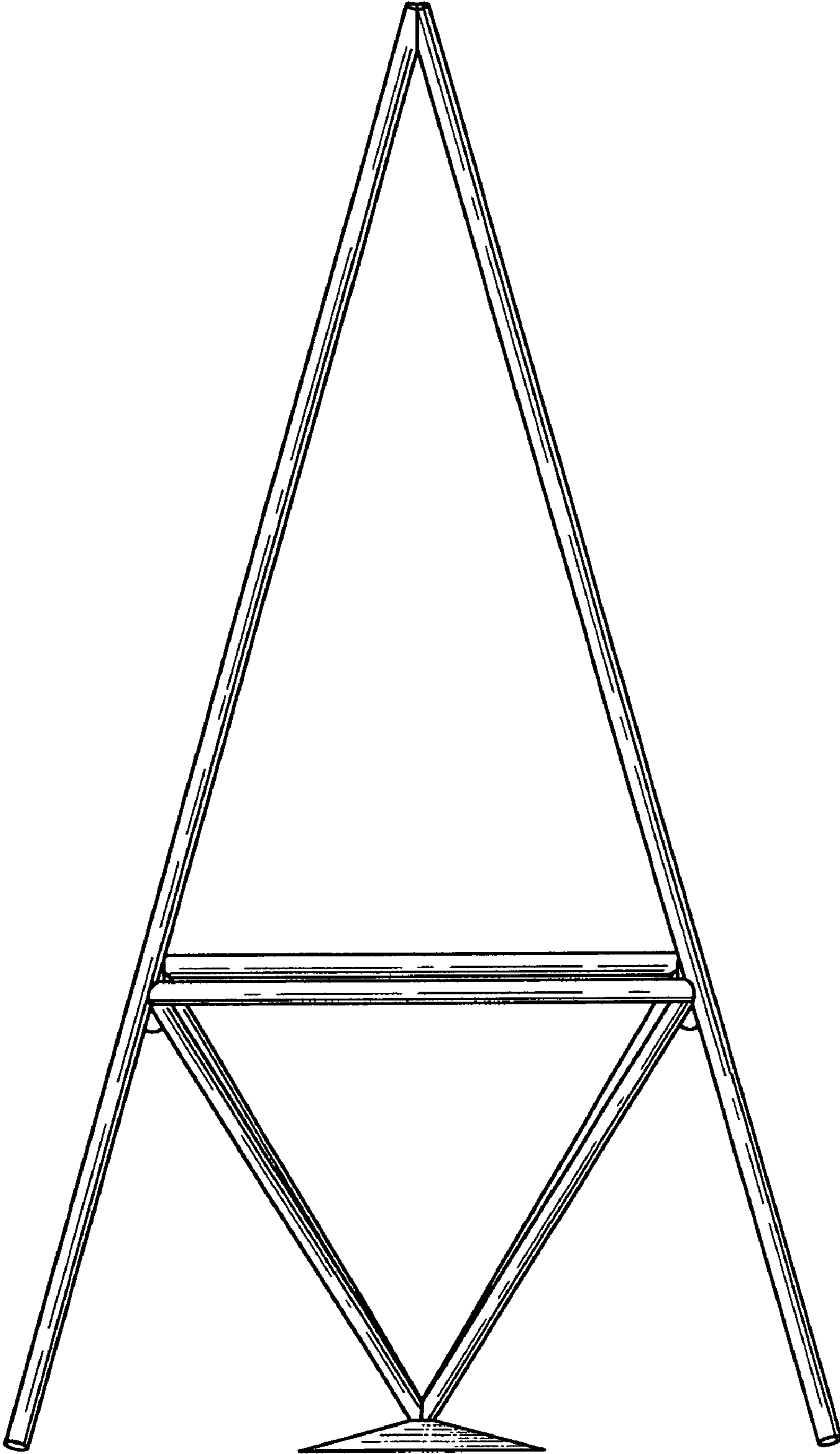

FIG. 4

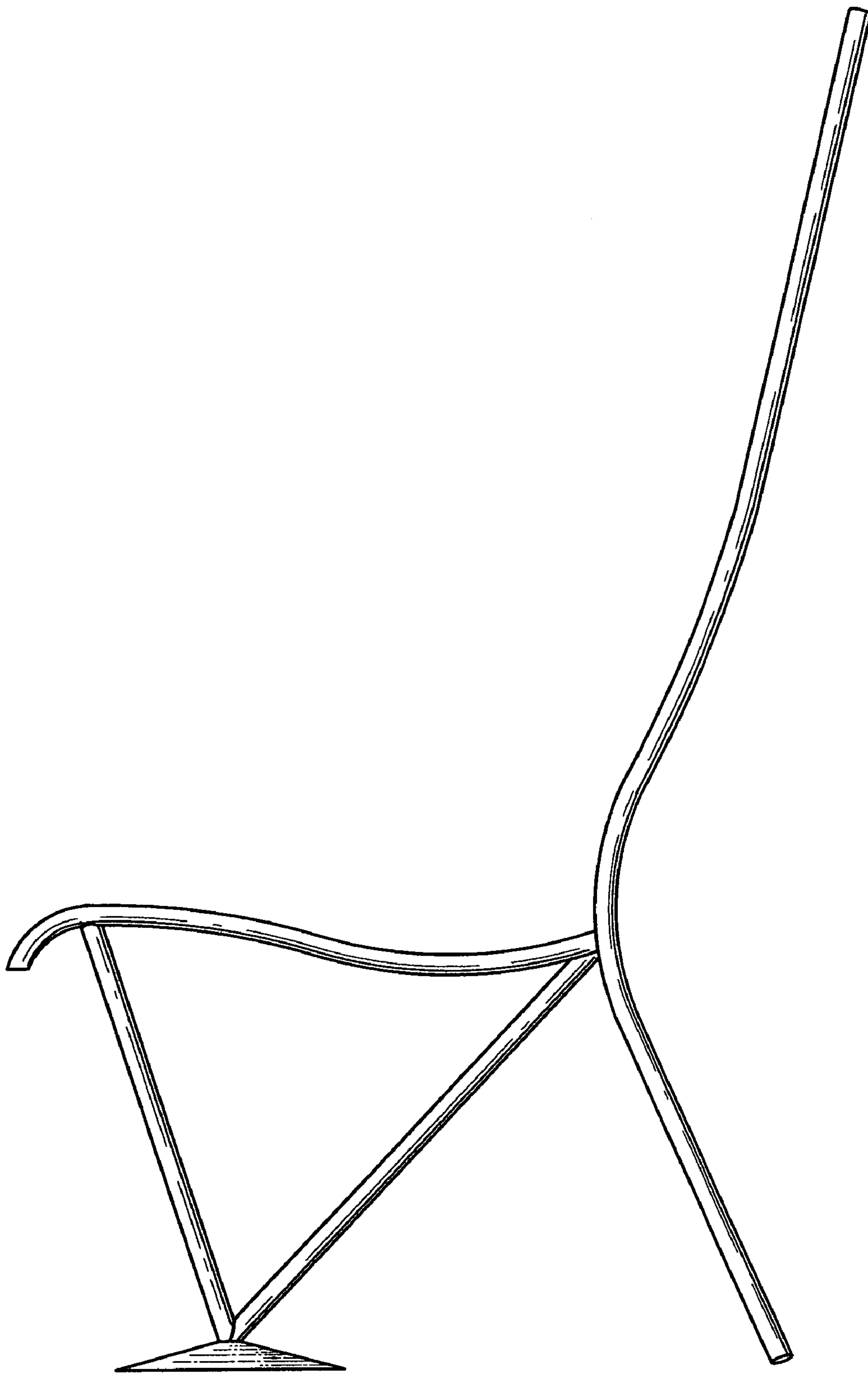

FIG. 5

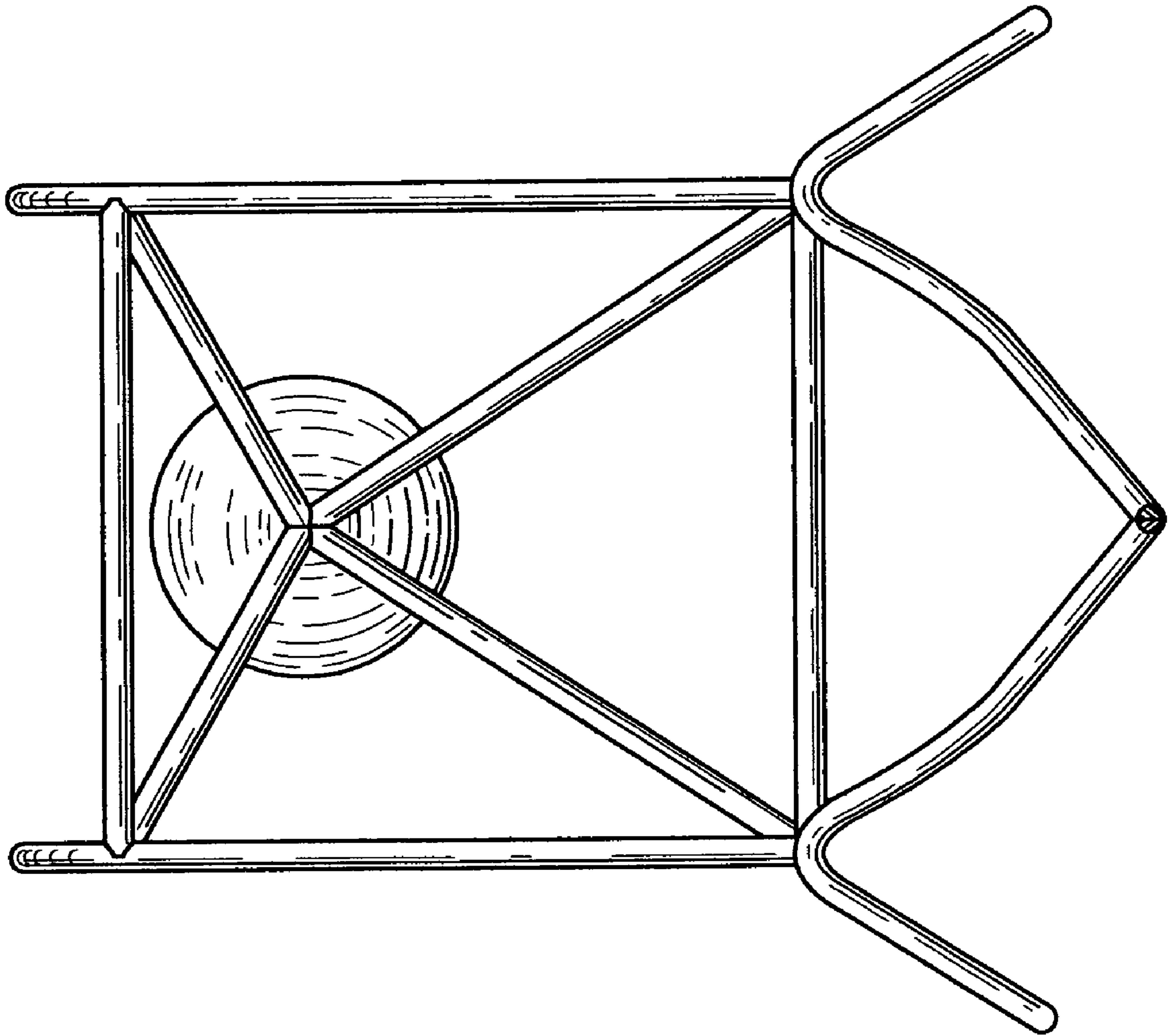

FIG. 6