

US00D544125S

(12) **United States Design Patent**
Guercio

(10) **Patent No.:** **US D544,125 S**

(45) **Date of Patent:** **** Jun. 5, 2007**

(54) **SLIP FIT MOUNT FLOODLIGHT**

(75) Inventor: **Vincenzo Guercio**, Wallkill, NY (US)

(73) Assignee: **RAB Lighting, Inc.**, Northvale, NJ (US)

(**) Term: **14 Years**

(21) Appl. No.: **29/215,465**

(22) Filed: **Oct. 19, 2004**

(51) **LOC (8) Cl.** **26-05**

(52) **U.S. Cl.** **D26/63; D26/92**

(58) **Field of Classification Search** D26/61-63,
D26/93, 118, 107, 128; 362/269, 277, 278,
362/282, 285, 287, 288, 410, 413, 418-430,
362/449

See application file for complete search history.

(56) **References Cited**

U.S. PATENT DOCUMENTS

D83,058 S *	1/1931	O'Neil	D26/24
D207,063 S *	2/1967	Sovatsky	D26/64
D287,413 S *	12/1986	Kusmer et al.	D26/65
D316,303 S *	4/1991	Layne	D26/63
D434,515 S *	11/2000	McNamara	D26/63

D506,284 S * 6/2005 Benghozi D26/128

* cited by examiner

Primary Examiner—Clare E Heflin

(74) *Attorney, Agent, or Firm*—Darby & Darby P.C.

(57) **CLAIM**

The ornamental design for a slip fit mount floodlight, as shown and described.

DESCRIPTION

FIG. 1 is an upward side perspective view of a slip fit mount floodlight;

FIG. 2 is an upward rear perspective view of the flood light of FIG. 1;

FIG. 3 is a front elevation view of the flood light of FIG. 1;

FIG. 4 is a right side elevation view of the flood light of FIG. 1;

FIG. 5 is a rear elevation view of the flood light of FIG. 1;

FIG. 6 is a left side elevation view of the flood light of FIG. 1;

FIG. 7 is a top plan view of the flood light of FIG. 1; and,

FIG. 8 is a bottom plan view of the flood light of FIG. 1.

1 Claim, 8 Drawing Sheets

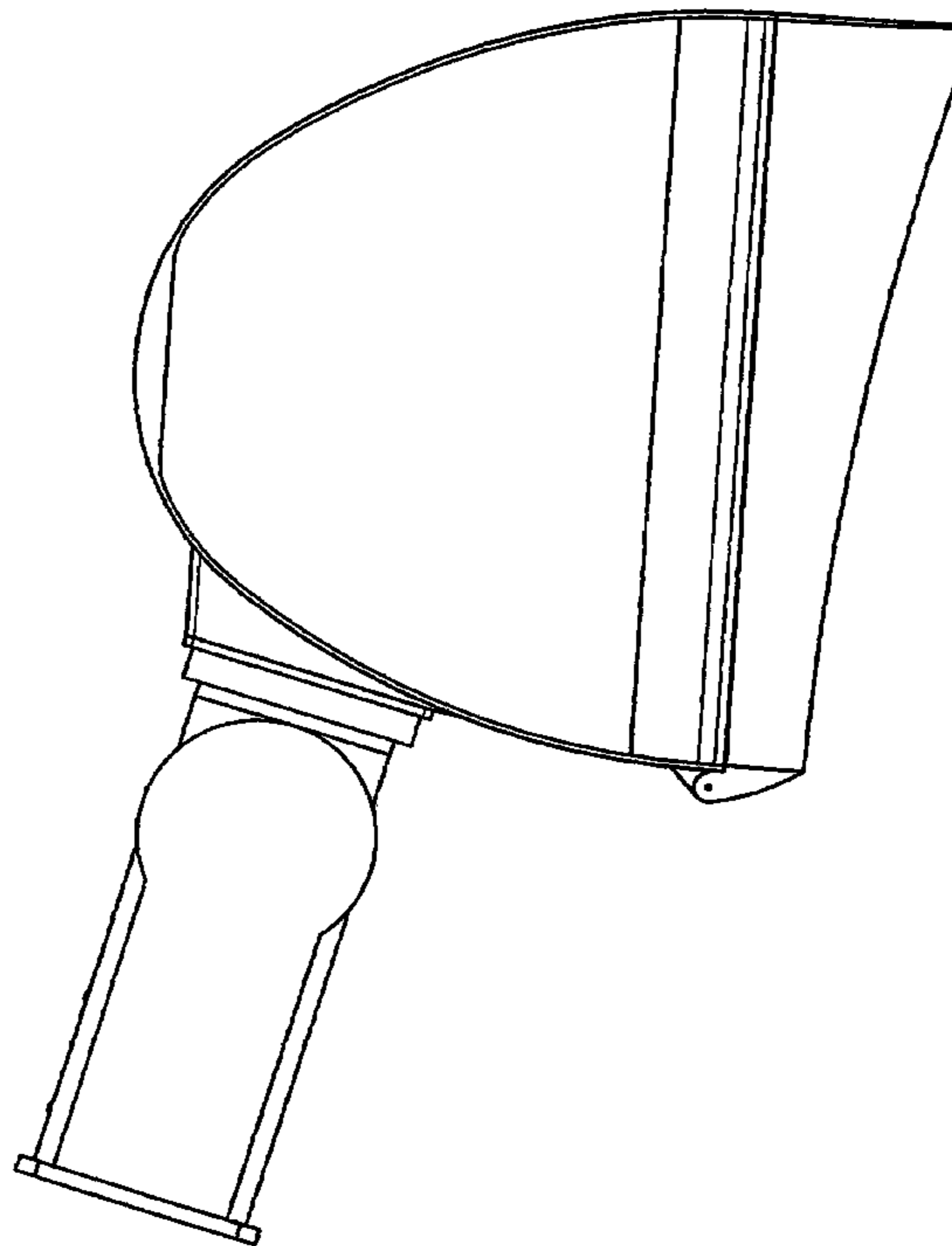
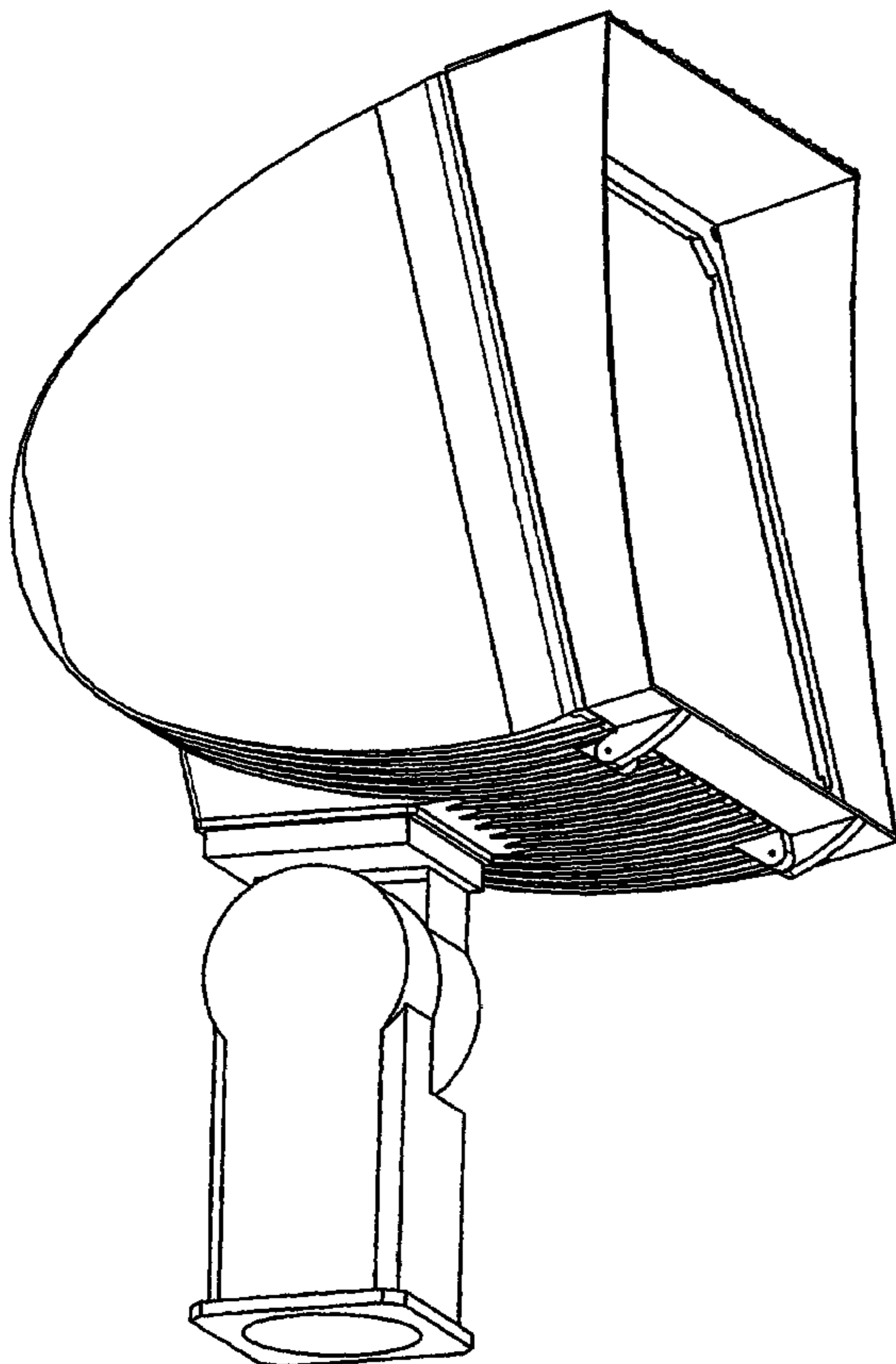

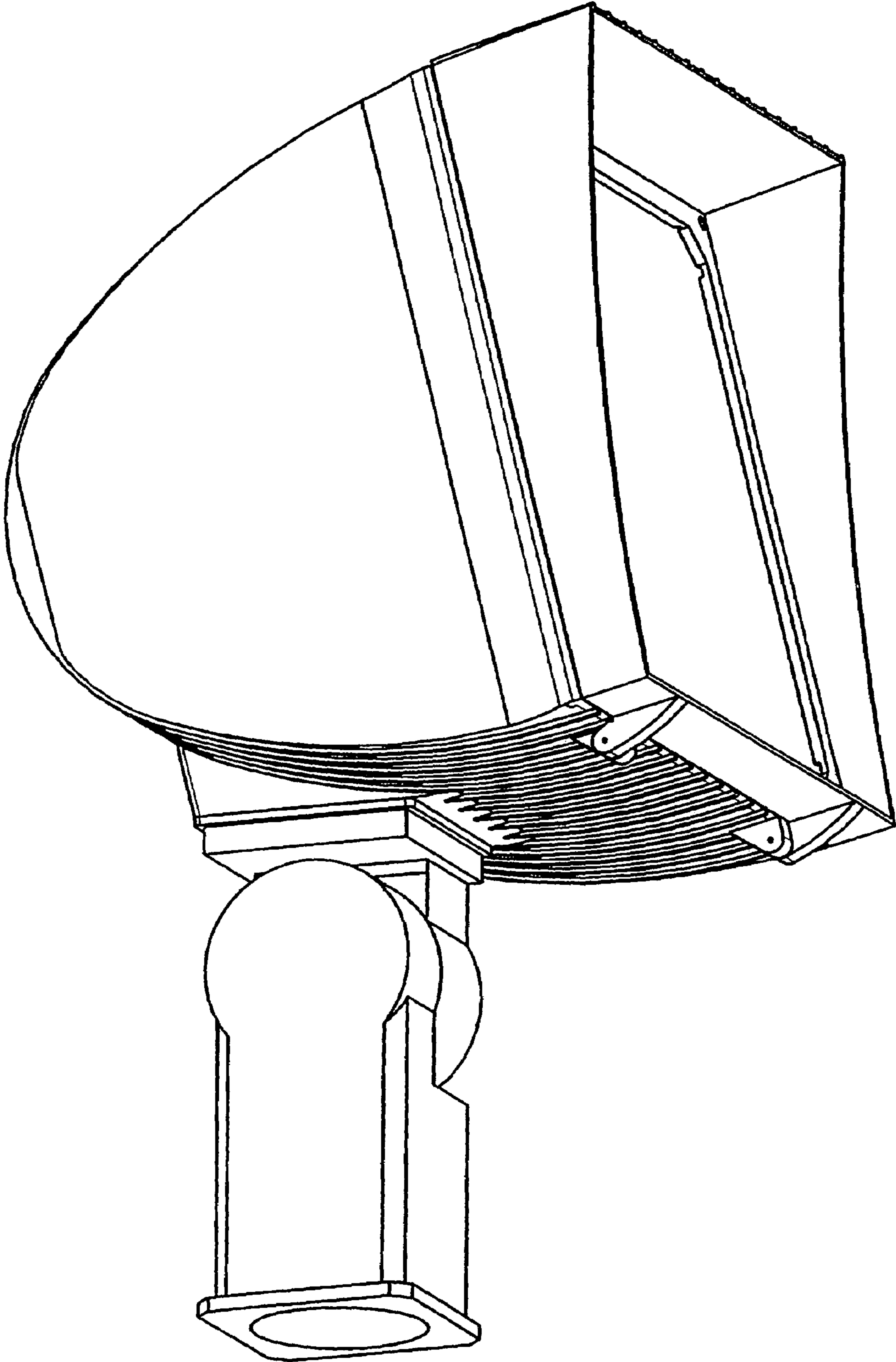

Figure 1

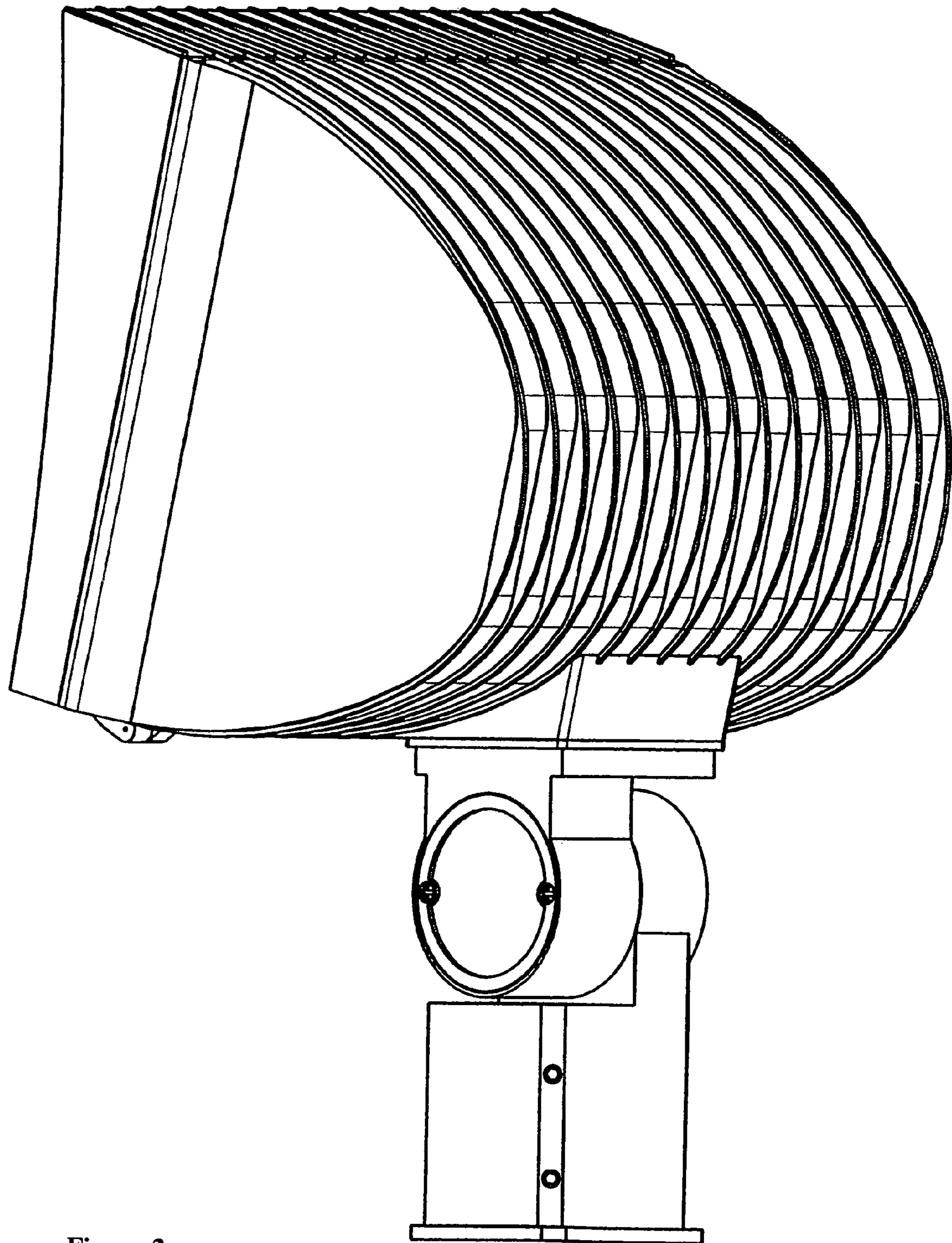

Figure 2

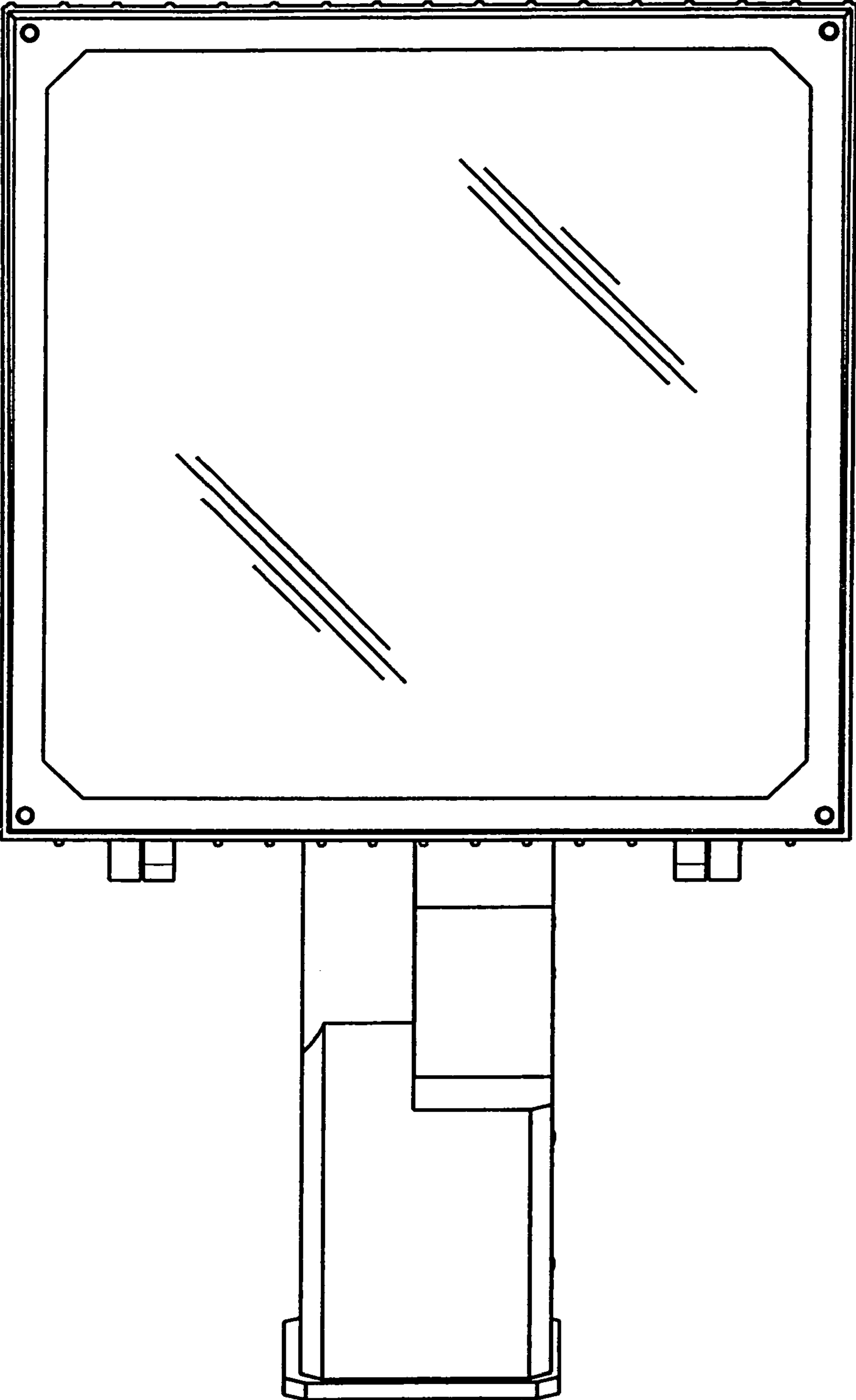

Figure 3

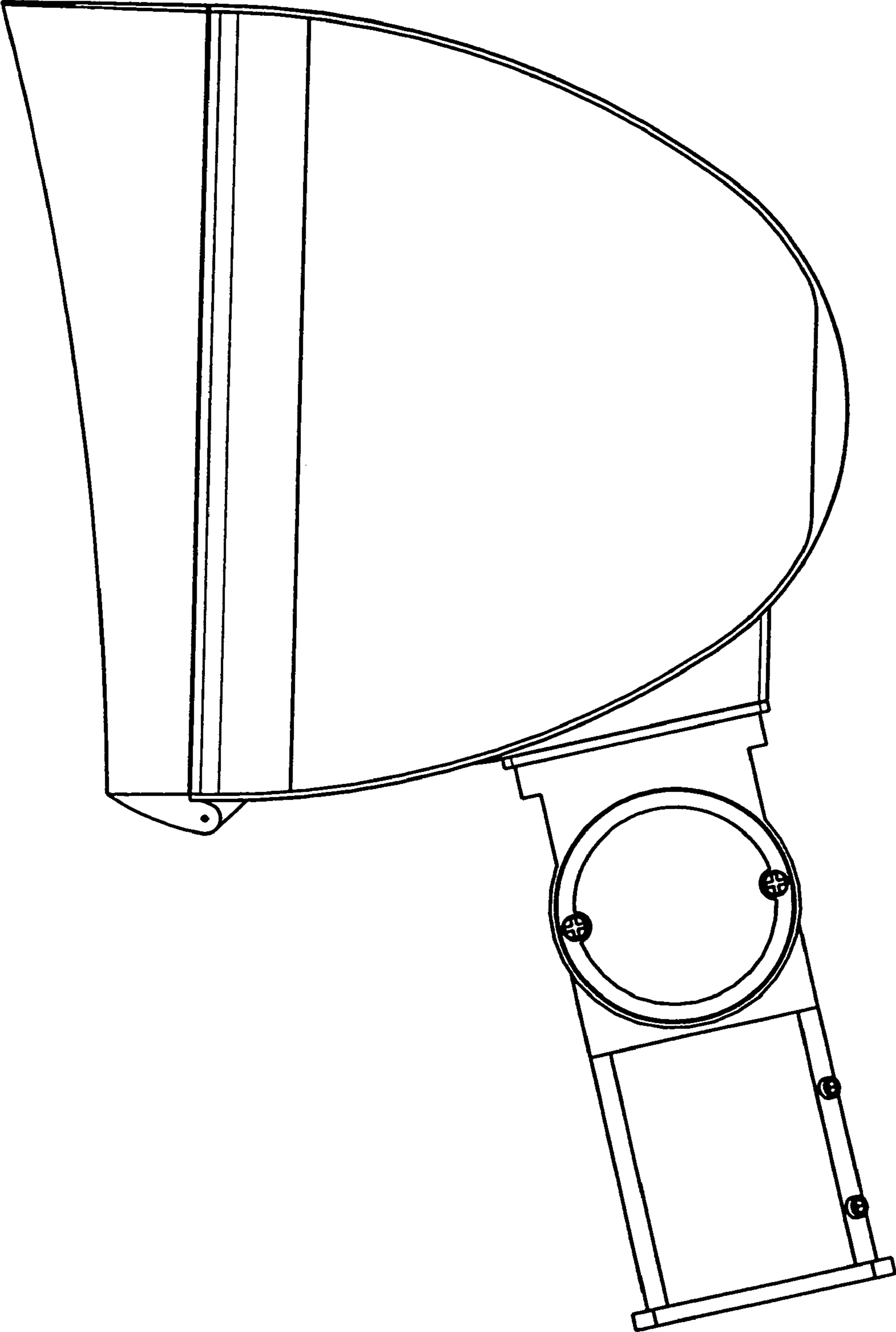

Figure 4

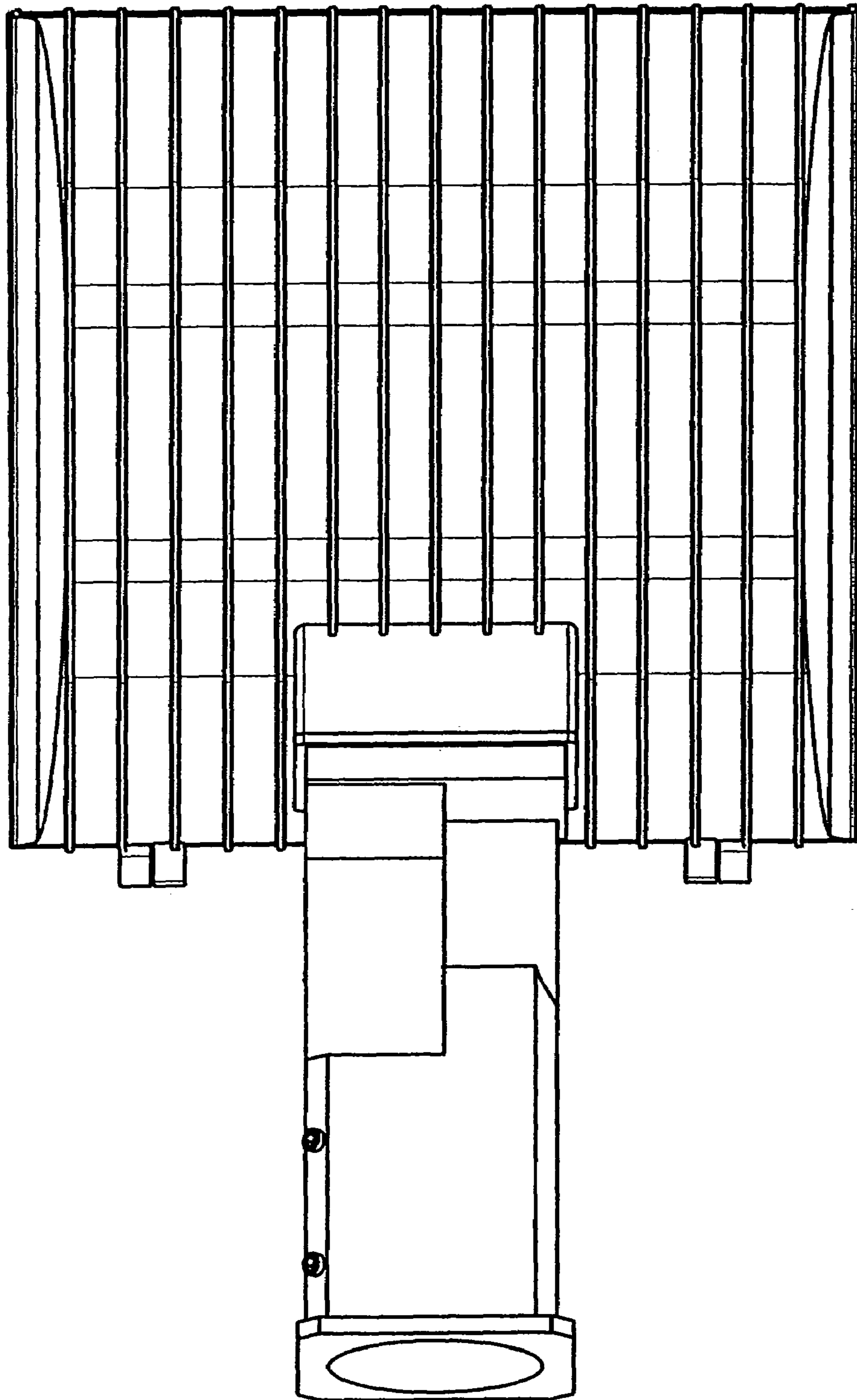

Figure 5

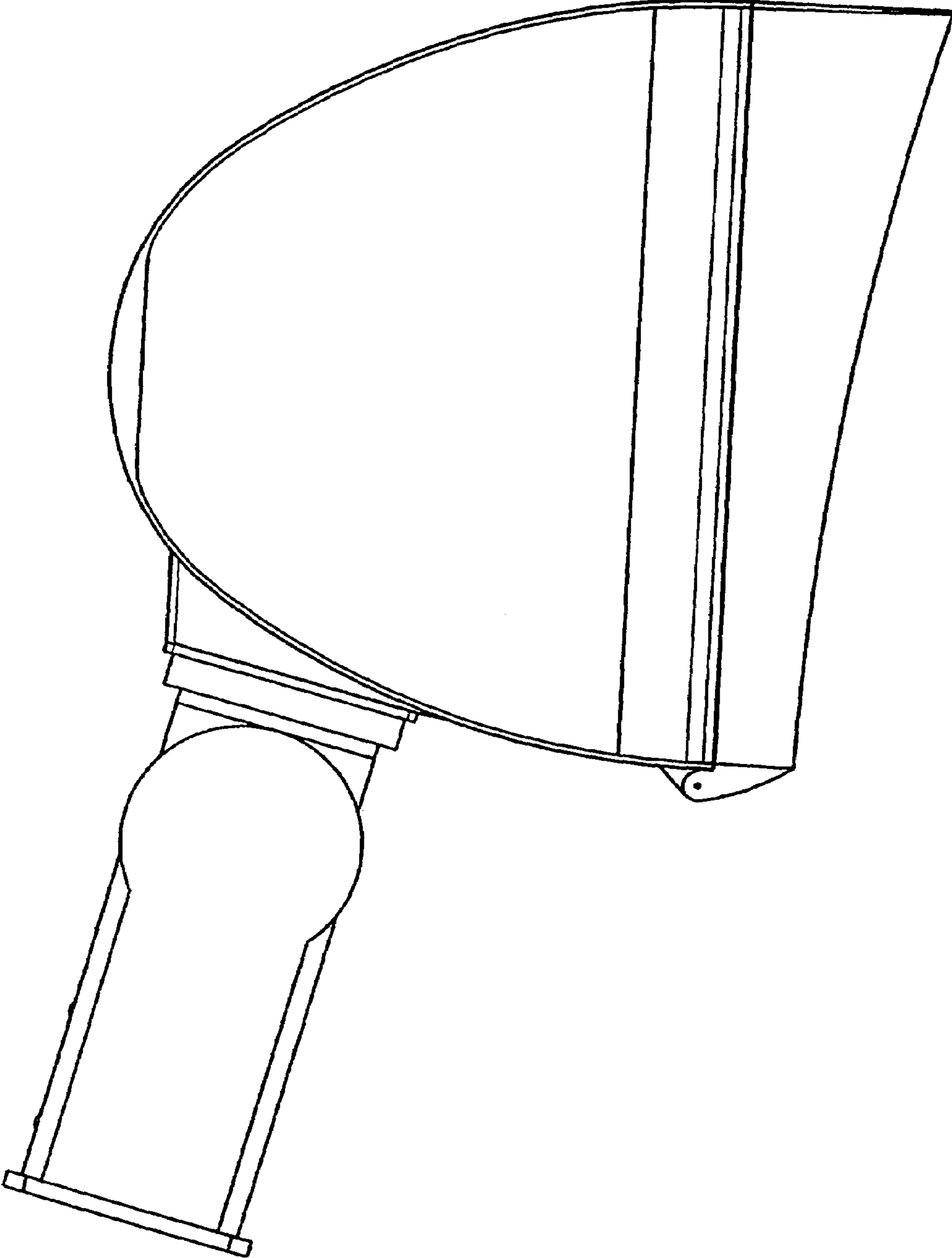

Figure 6

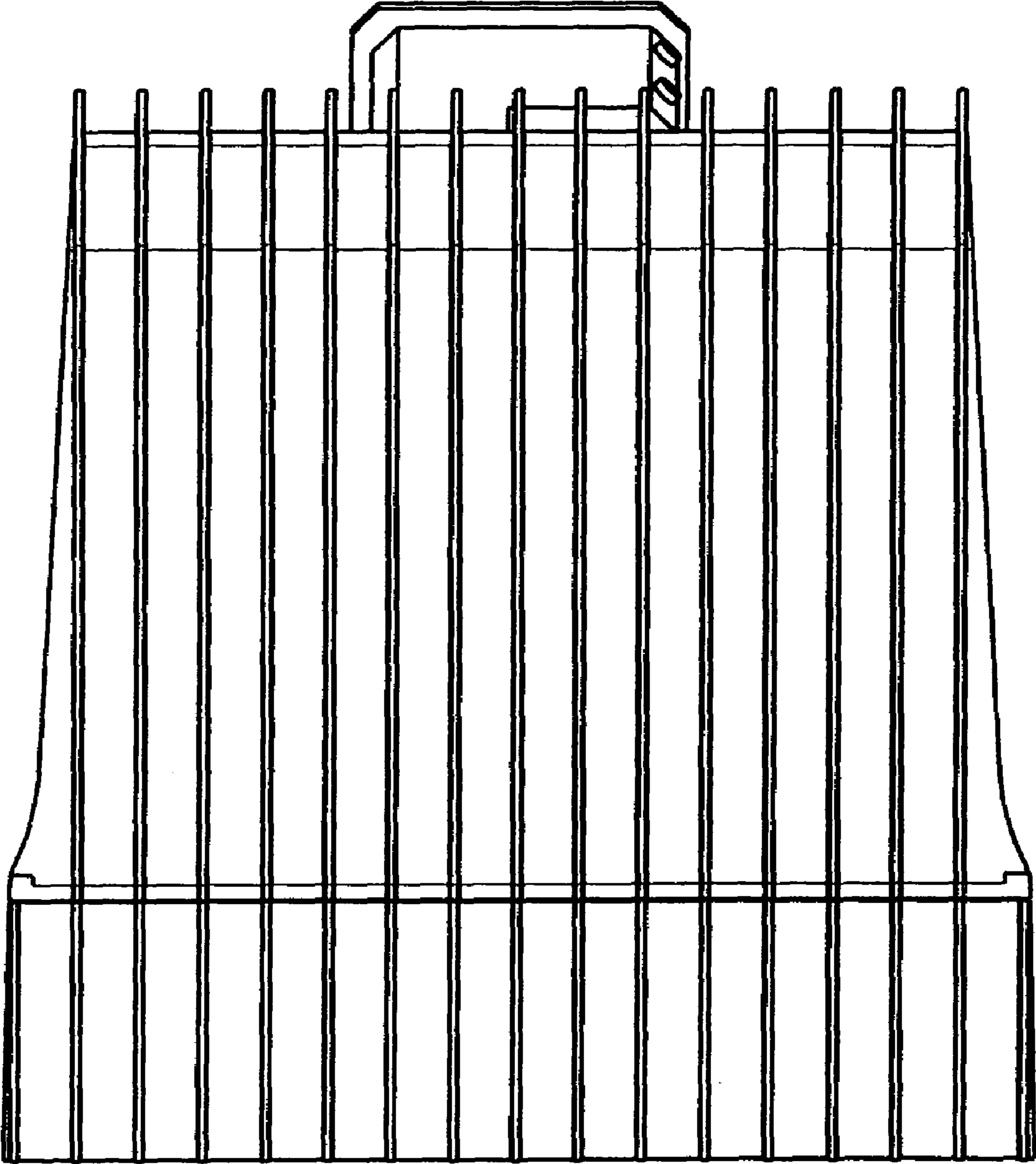

Figure 7

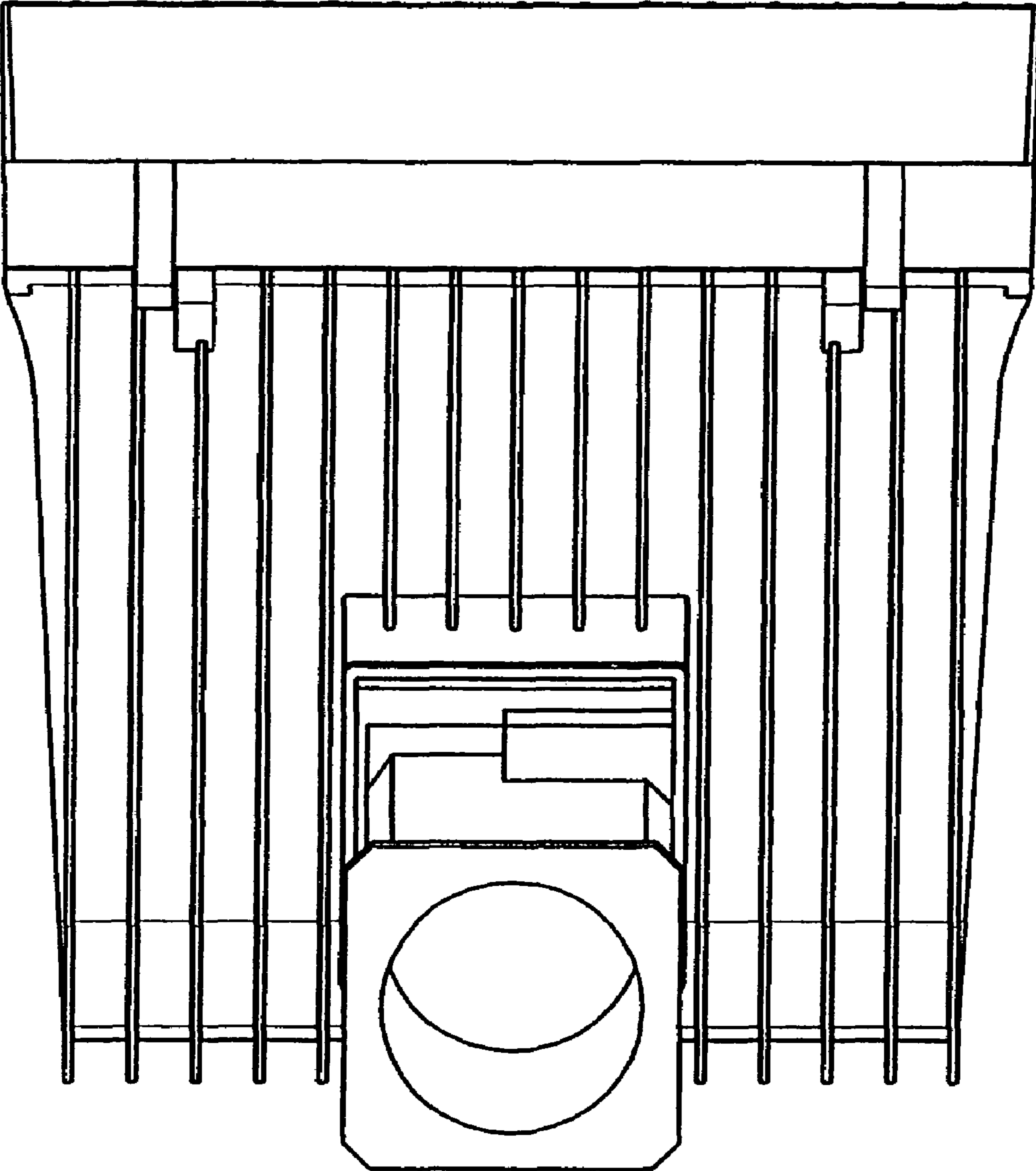

Figure 8