

US00D544079S

(12) **United States Design Patent**
Bucher et al.

(10) **Patent No.:** **US D544,079 S**

(45) **Date of Patent:** **** Jun. 5, 2007**

(54) **DECORATIVE FLOOR AND TABLE TOP HEATER**

(75) Inventors: **John C. Bucher**, Hillsboro Bch, FL (US); **William Ross Boswell**, Bentonville, AR (US); **Chad Ricker**, North Lauderdale, FL (US)

(73) Assignee: **King of Fans, Inc.**, Fort Lauderdale, FL (US)

(**) Term: **14 Years**

(21) Appl. No.: **29/240,601**

(22) Filed: **Oct. 14, 2005**

(51) **LOC (8) Cl.** **23-03**

(52) **U.S. Cl.** **D23/335**

(58) **Field of Classification Search** D23/332, D23/314, 335-338, 340-345, 349-350; 392/360, 392/365-369, 373-376; 312/326; 126/110 B, 126/90 A, 92 A

See application file for complete search history.

(56) **References Cited**

U.S. PATENT DOCUMENTS

D322,669 S	12/1991	Yamamoto et al.	D23/378
D329,284 S	9/1992	Patton	D23/378
D423,093 S	4/2000	Fok et al.	D23/378

D459,454 S	*	6/2002	Shapiro	D23/335
D462,429 S	*	9/2002	Gao	D23/335
D464,723 S		10/2002	Fok et al.	D23/378
D479,874 S		9/2003	Shapiro	D23/378
D499,472 S	*	12/2004	Ching	D23/332
D516,688 S	*	3/2006	Blateri	D23/335

* cited by examiner

Primary Examiner—Brian N Vinson

(74) *Attorney, Agent, or Firm*—Brian S. Steinberger; Law Offices of Brian S. Steinberger, P.A.

(57) **CLAIM**

The ornamental design for a decorative floor and table top heater, as shown and described.

DESCRIPTION

FIG. 1 is a right front perspective view of a decorative floor and table top heater showing our new design; FIG. 2 is a left front perspective view thereof; FIG. 3 is a right rear perspective view thereof; FIG. 4 is a left rear perspective view thereof; FIG. 5 is a left side view thereof; FIG. 6 is a right side view thereof; FIG. 7 is a front view thereof; FIG. 8 is a rear view thereof; FIG. 9 is top perspective view thereof; and, FIG. 10 is bottom view thereof.

1 Claim, 10 Drawing Sheets

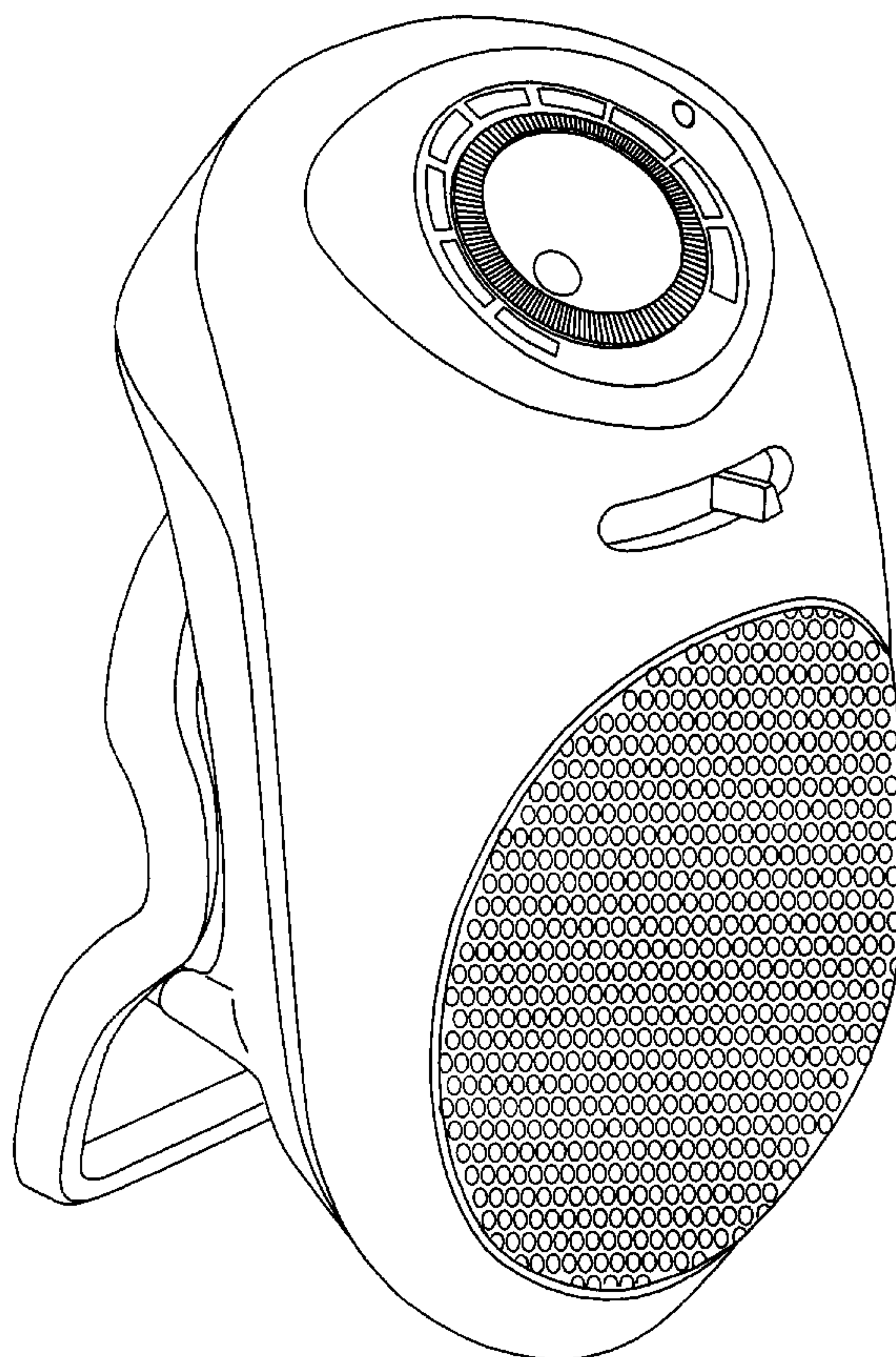

FIG. 1

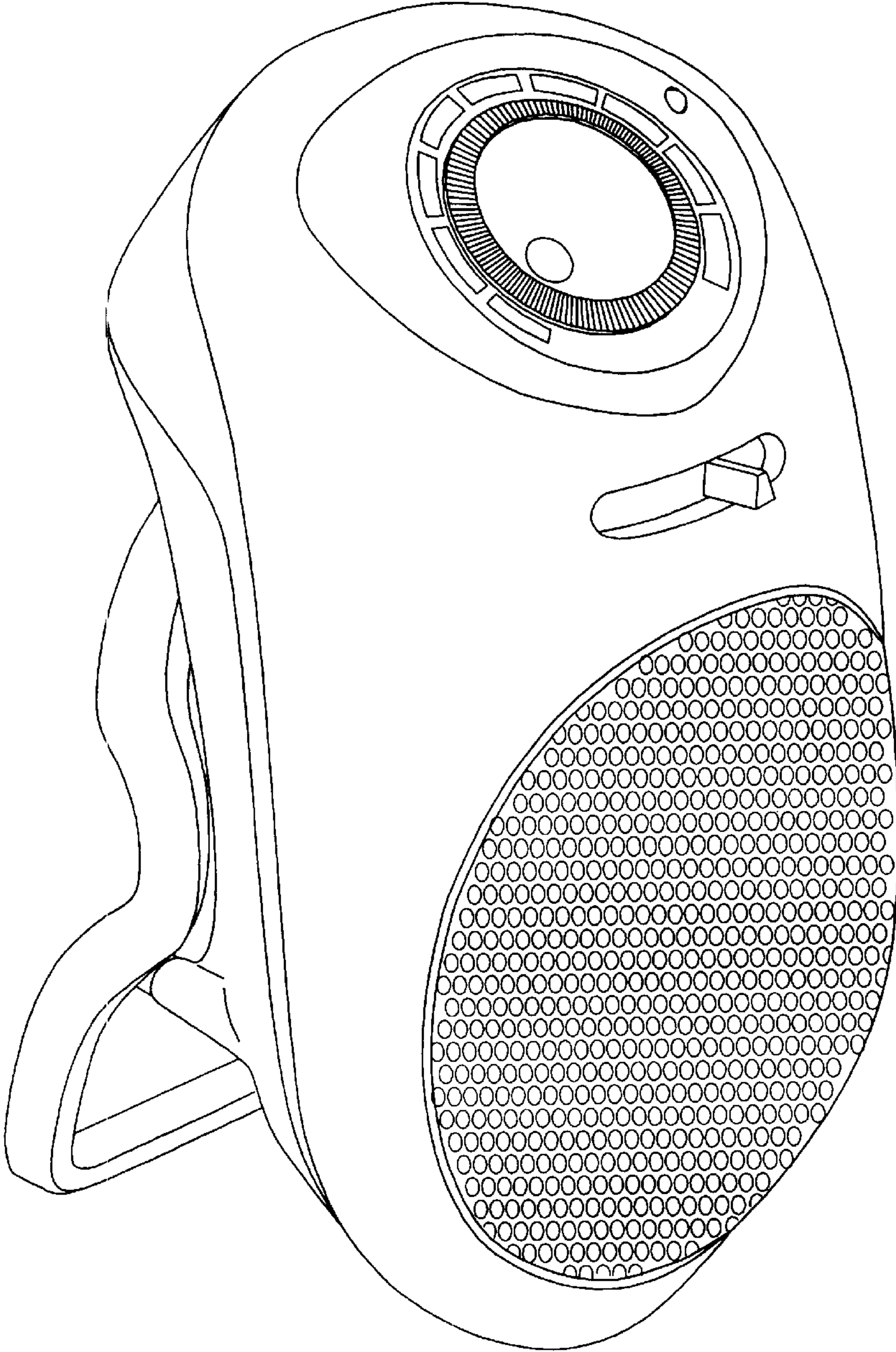

FIG. 2

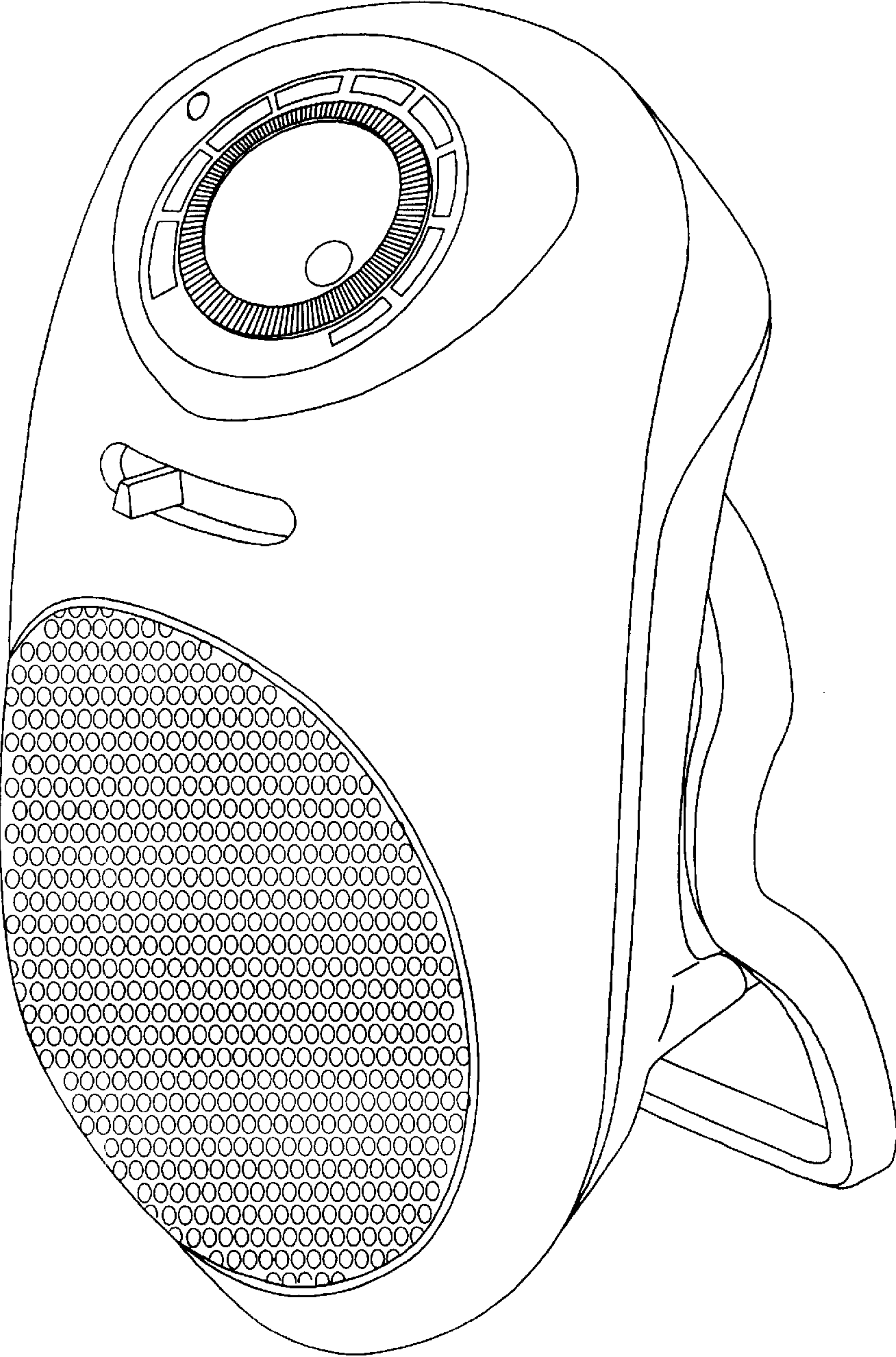

FIG. 3

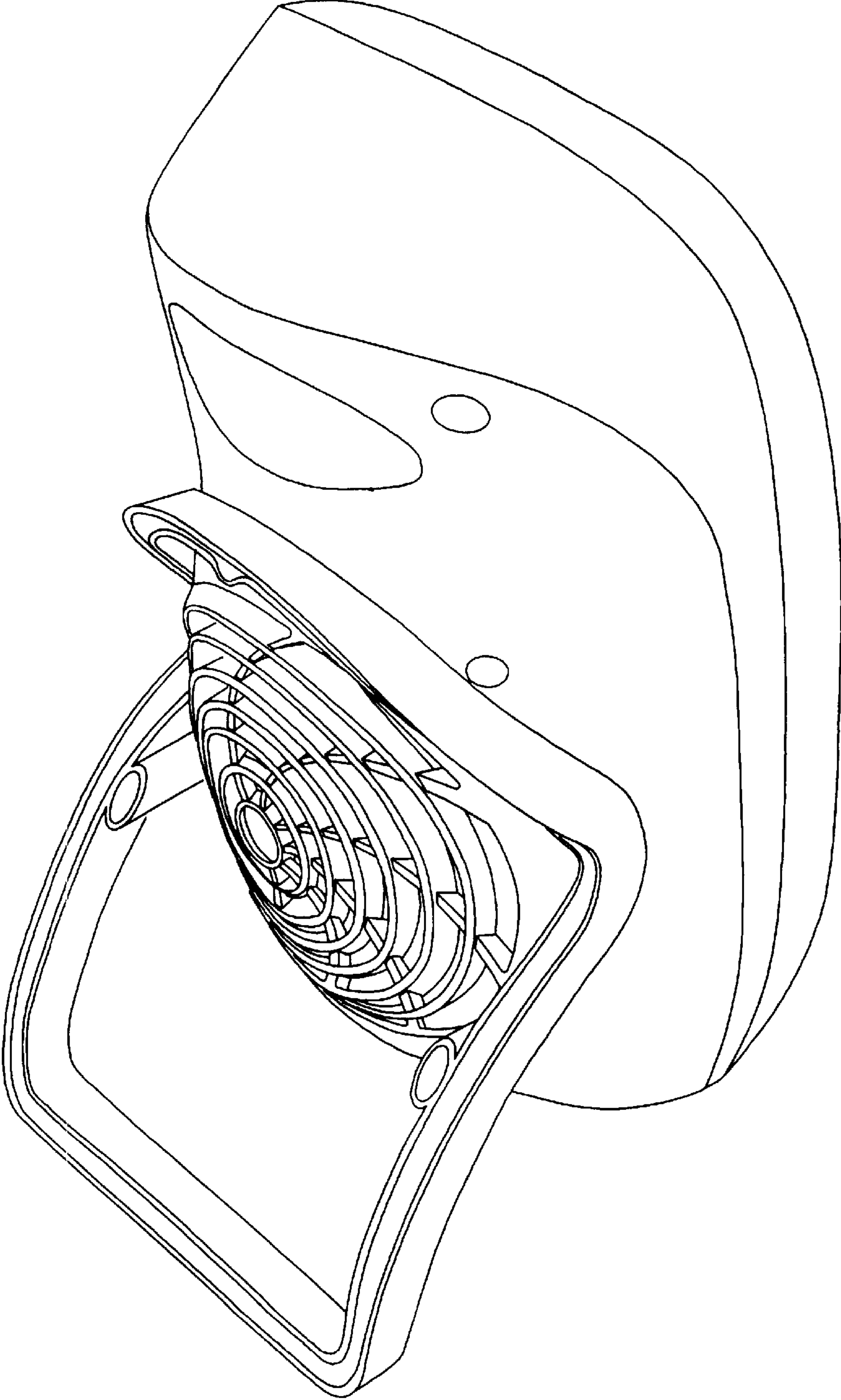

FIG. 4

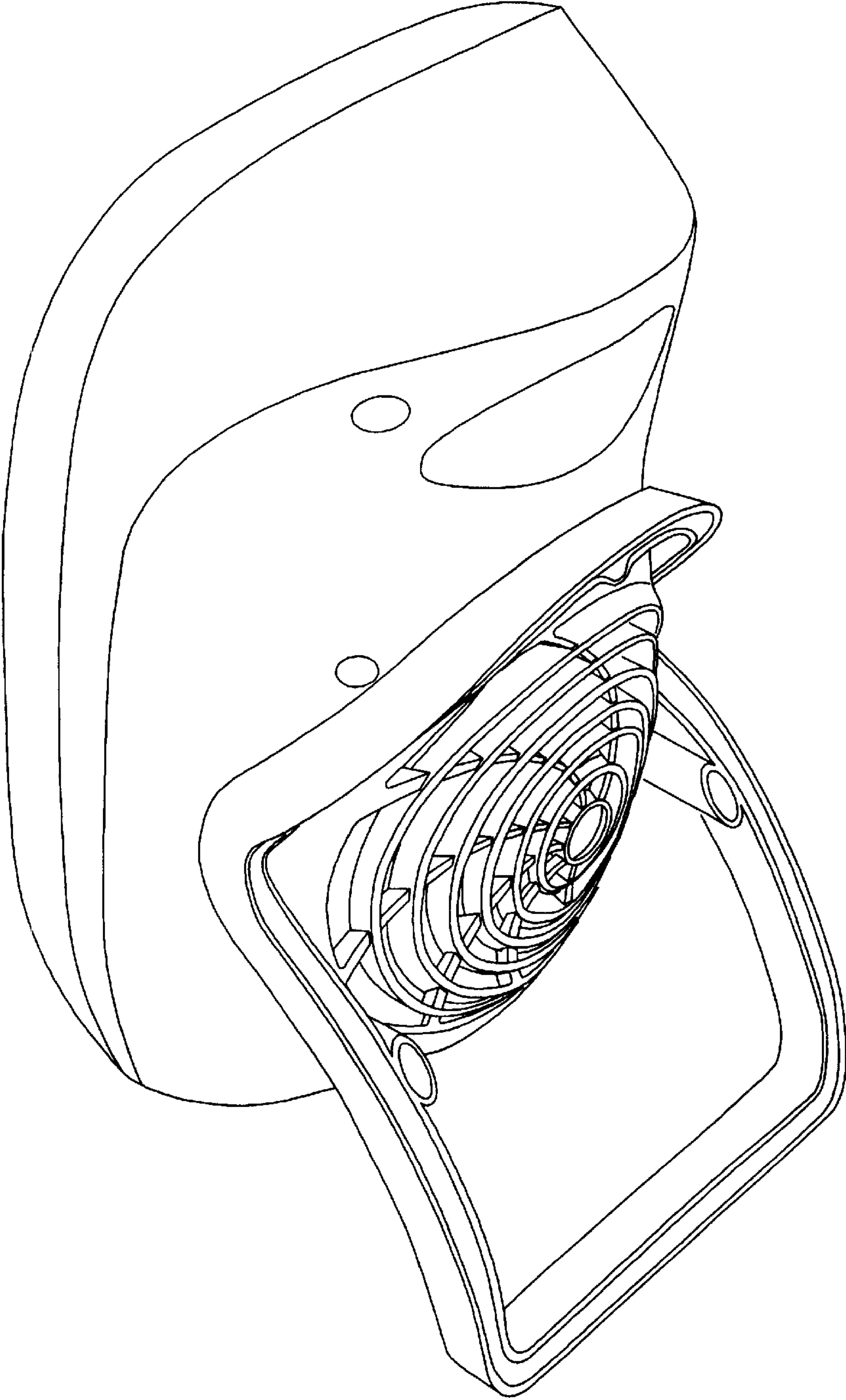

FIG. 5

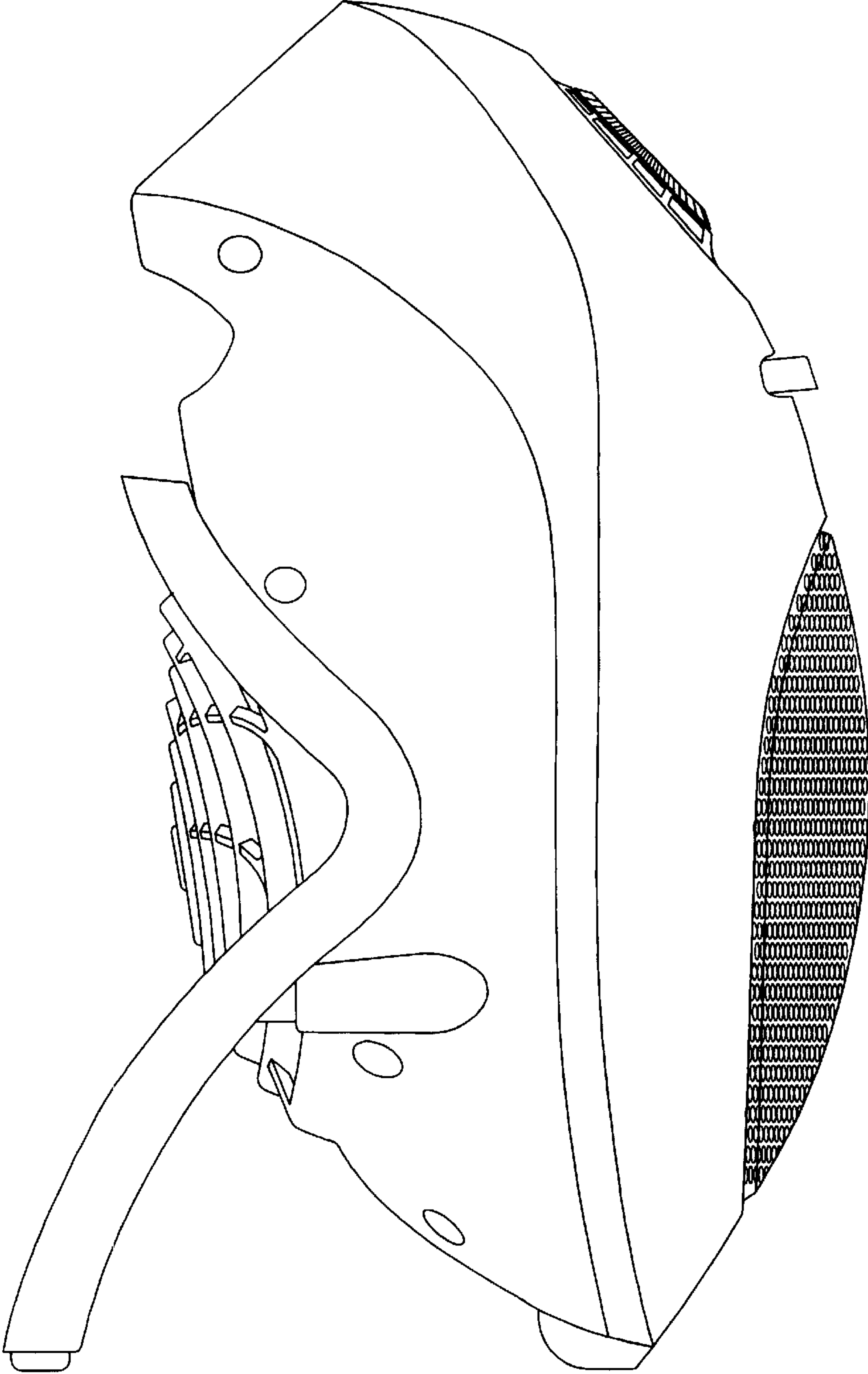

FIG. 6

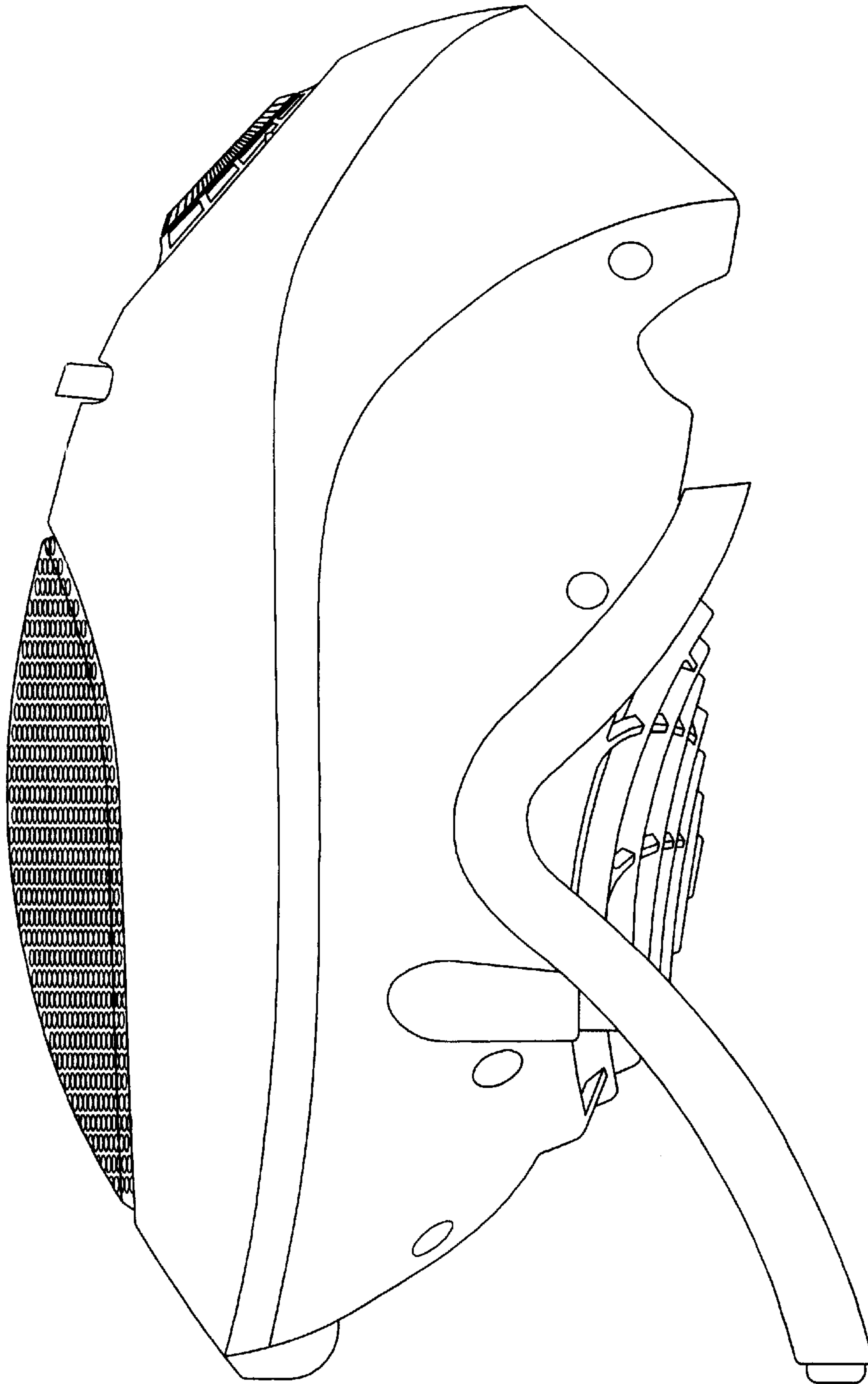

FIG. 7

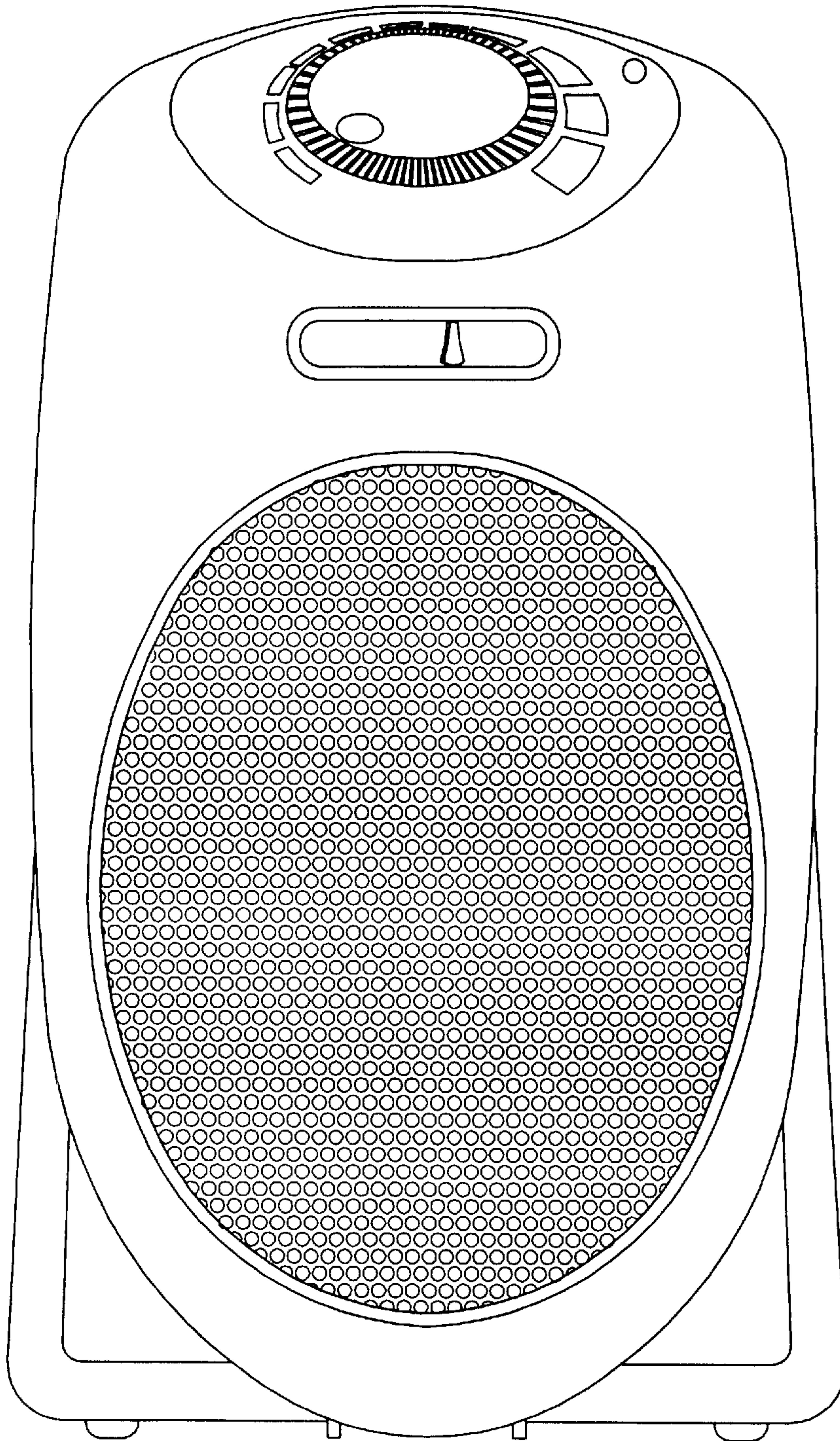

FIG. 8

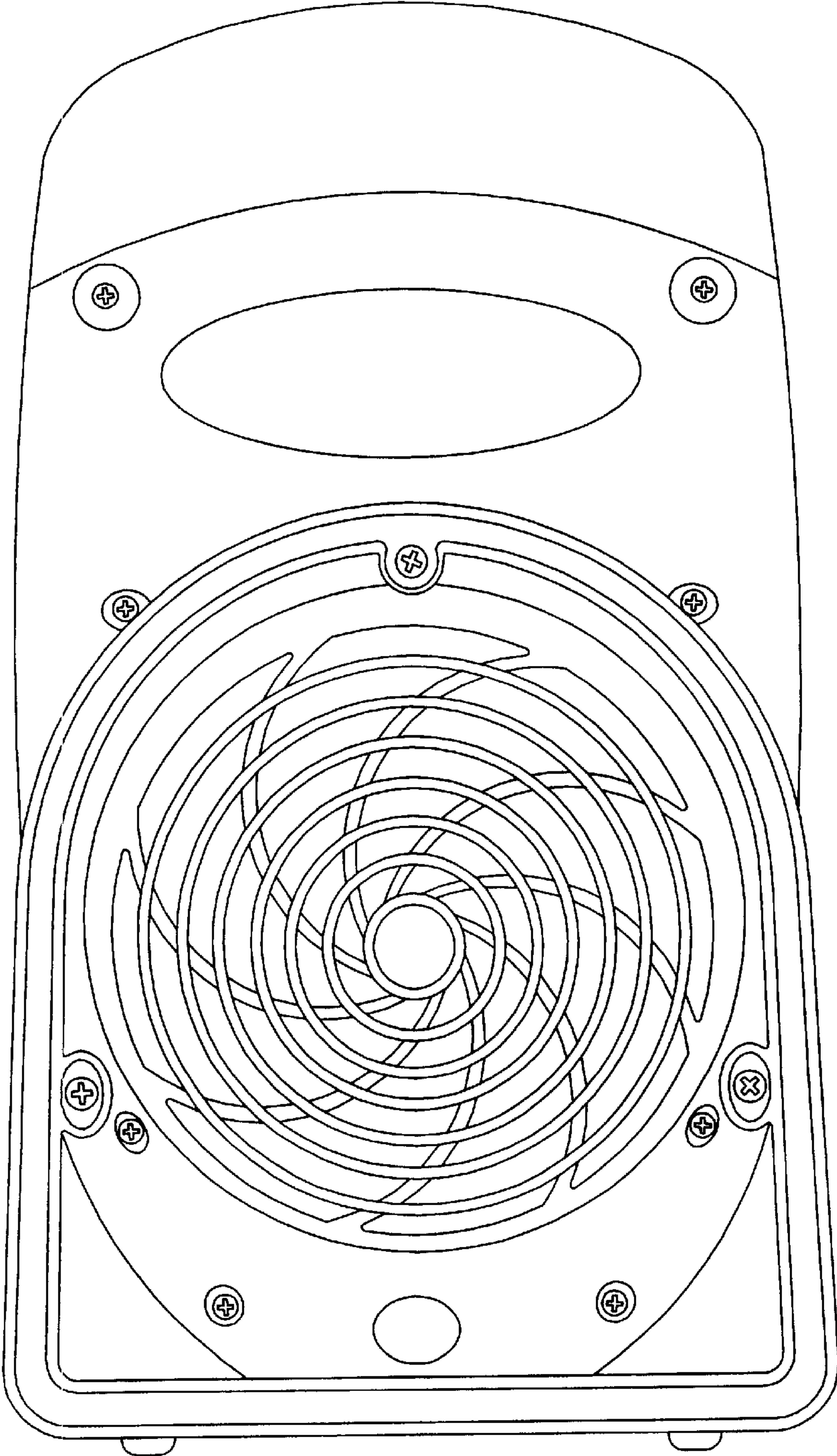

FIG. 9

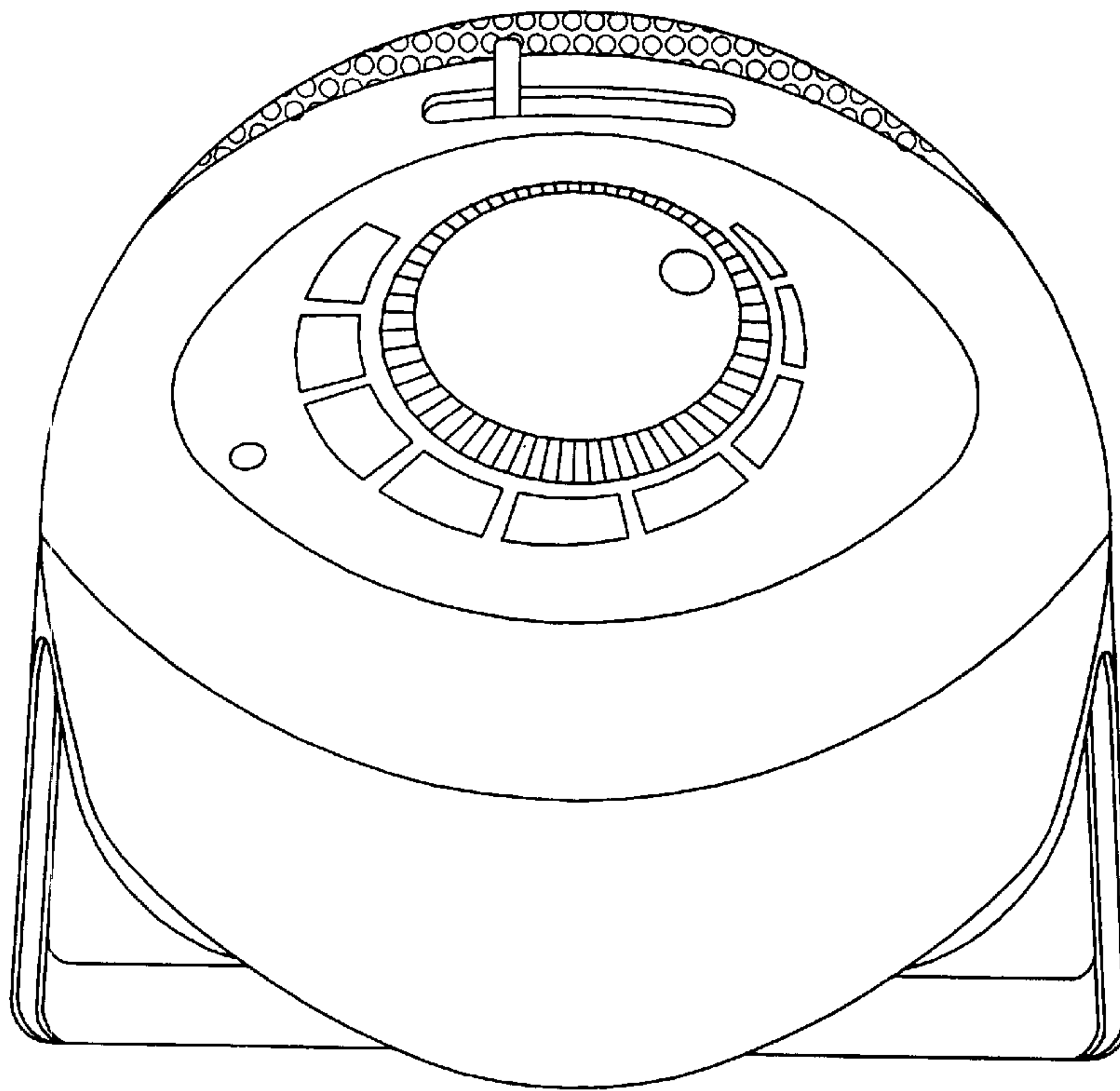

FIG. 10

