



US00D544055S

(12) **United States Design Patent** (10) **Patent No.:** **US D544,055 S**
Wieland et al. (45) **Date of Patent:** **** *Jun. 5, 2007**

(54) **IRON GOLF CLUB HEAD**

(75) Inventors: **Chris J. Wieland**, Vista, CA (US);
Roger Cleveland, Los Angeles, CA
(US); **Homer E. Aguinaldo**, San Diego,
CA (US); **Karl A. Clausen**, San
Marcos, CA (US); **Lionel Poincenot**,
Carlsbad, CA (US)

(73) Assignee: **Callaway Golf Company**, Carlsbad,
CA (US)

(*) Notice: This patent is subject to a terminal dis-
claimer.

(**) Term: **14 Years**

(21) Appl. No.: **29/237,404**

(22) Filed: **Aug. 30, 2005**

(51) **LOC (8) Cl.** **21-02**

(52) **U.S. Cl.** **D21/747**

(58) **Field of Classification Search** D21/747-751;
473/324-331, 350

See application file for complete search history.

(56) **References Cited**

U.S. PATENT DOCUMENTS

D368,756 S * 4/1996 Blough et al. D21/748
D368,946 S * 4/1996 Blough et al. D21/748

D368,947 S * 4/1996 Blough et al. D21/748
D464,387 S * 10/2002 Rollinson et al. D21/748
D464,693 S * 10/2002 Rollinson et al. D21/748
D496,419 S * 9/2004 Lang et al. D21/747
D498,277 S * 11/2004 Lang et al. D21/747
D507,816 S * 7/2005 Lang et al. D21/759
D512,757 S * 12/2005 Cleveland et al. D21/747

* cited by examiner

Primary Examiner—Mitchell Siegel

(74) *Attorney, Agent, or Firm*—Michael A. Catania; Elaine
H. Lo

(57) **CLAIM**

The ornamental design for an iron golf club head, as shown
and described.

DESCRIPTION

FIG. 1 is a front elevational view of an iron golf club head;
FIG. 2 is a rear elevational view thereof;

FIG. 3 is a cross-sectional view taken along line 3-3 of FIG.
2;

FIG. 4 is a top plan view thereof;

FIG. 5 is a bottom plan view;

FIG. 6 is a heel end view thereof; and,

FIG. 7 is a toe end view thereof.

The broken line showing is for illustrative purposes only and
forms no part of the claimed design.

1 Claim, 3 Drawing Sheets

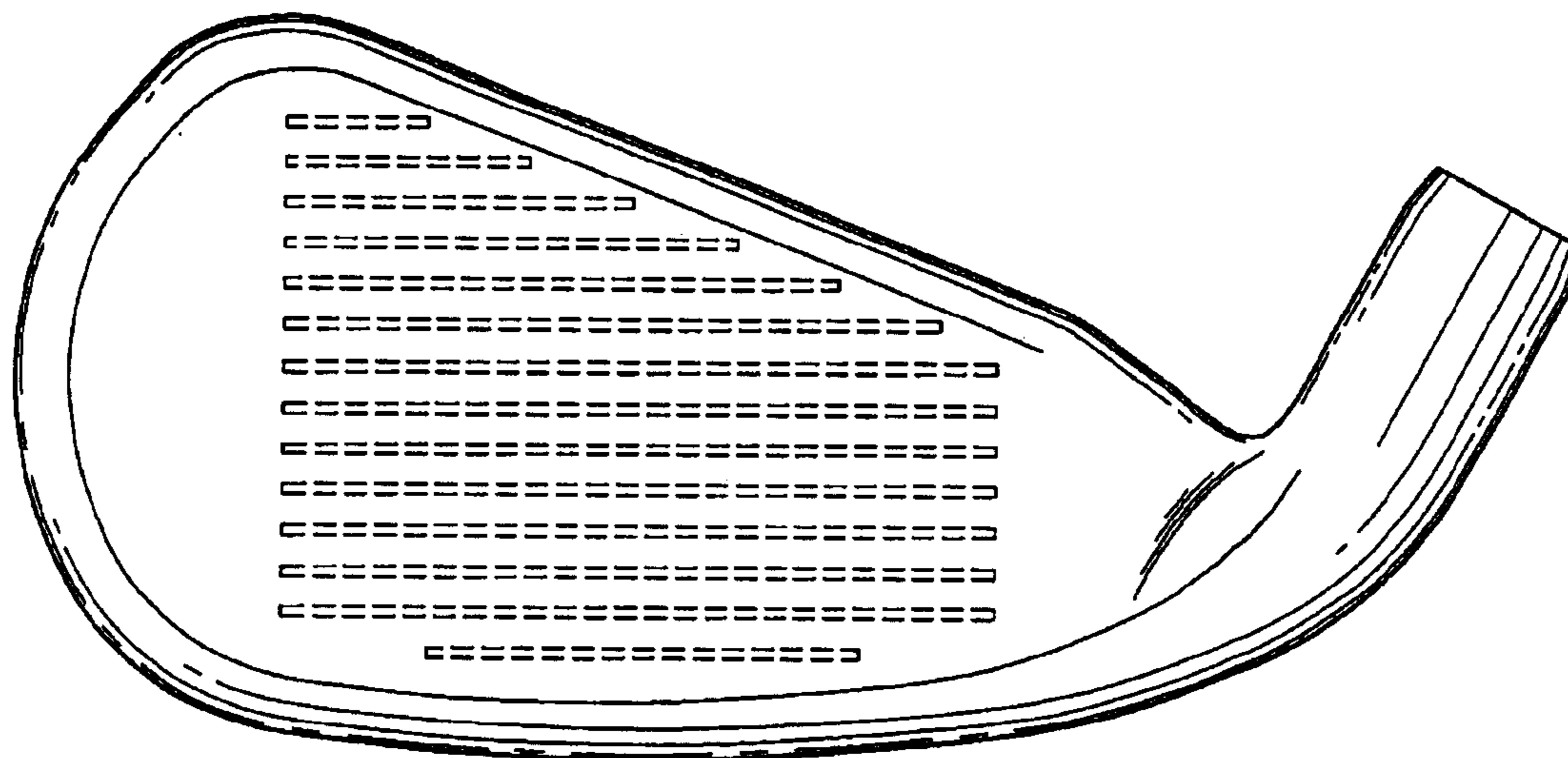

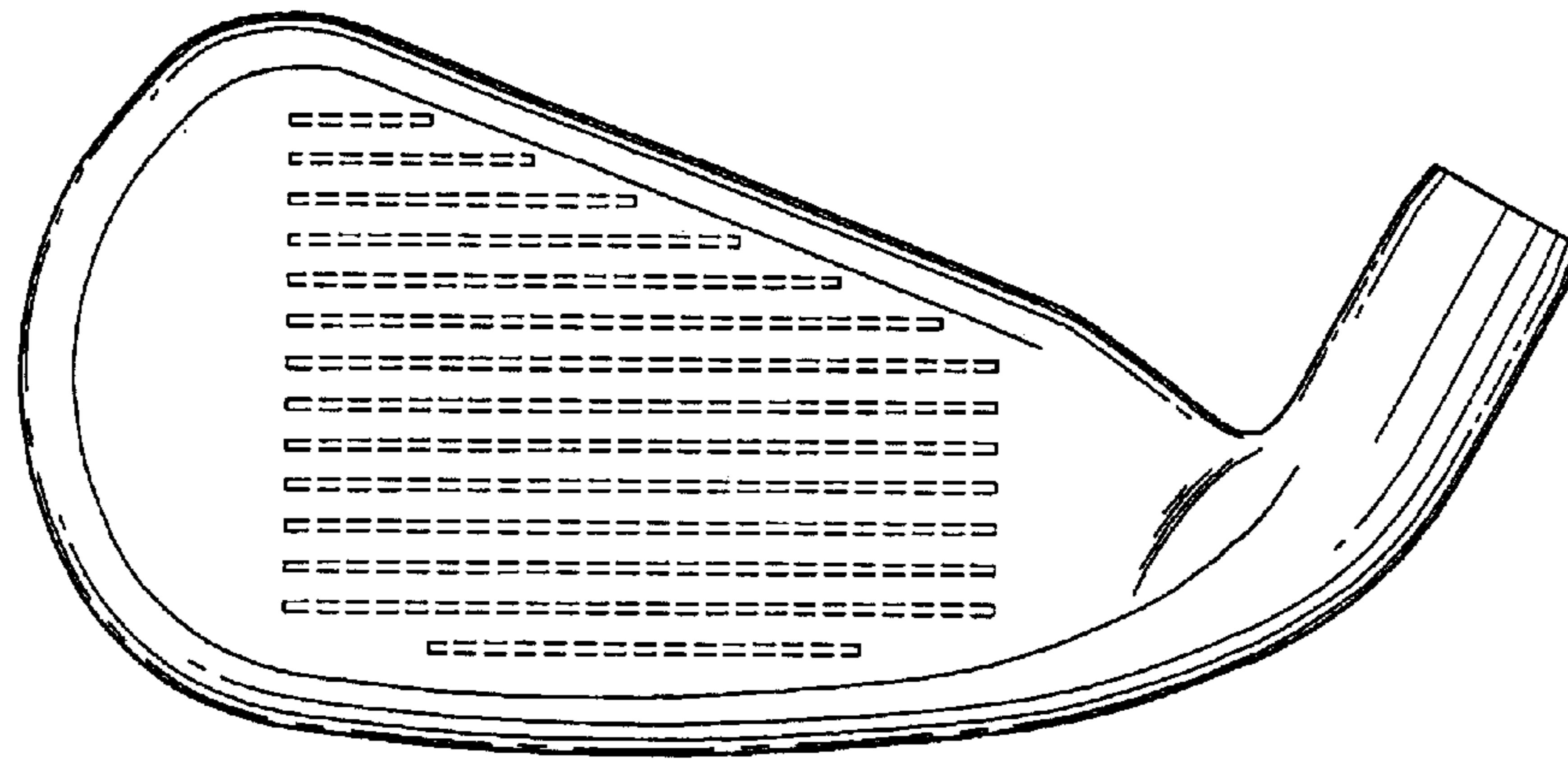

FIG. 1

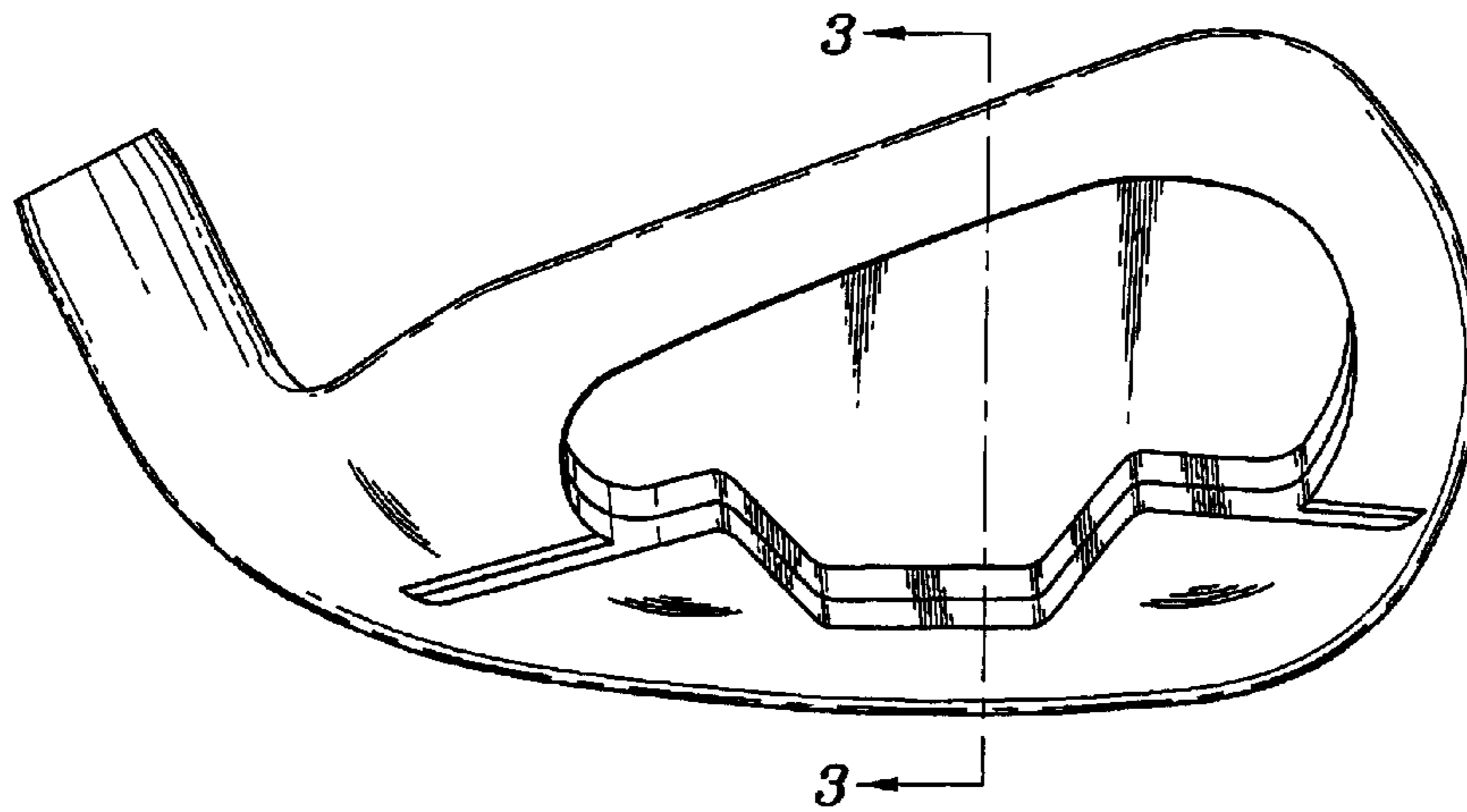

FIG. 2

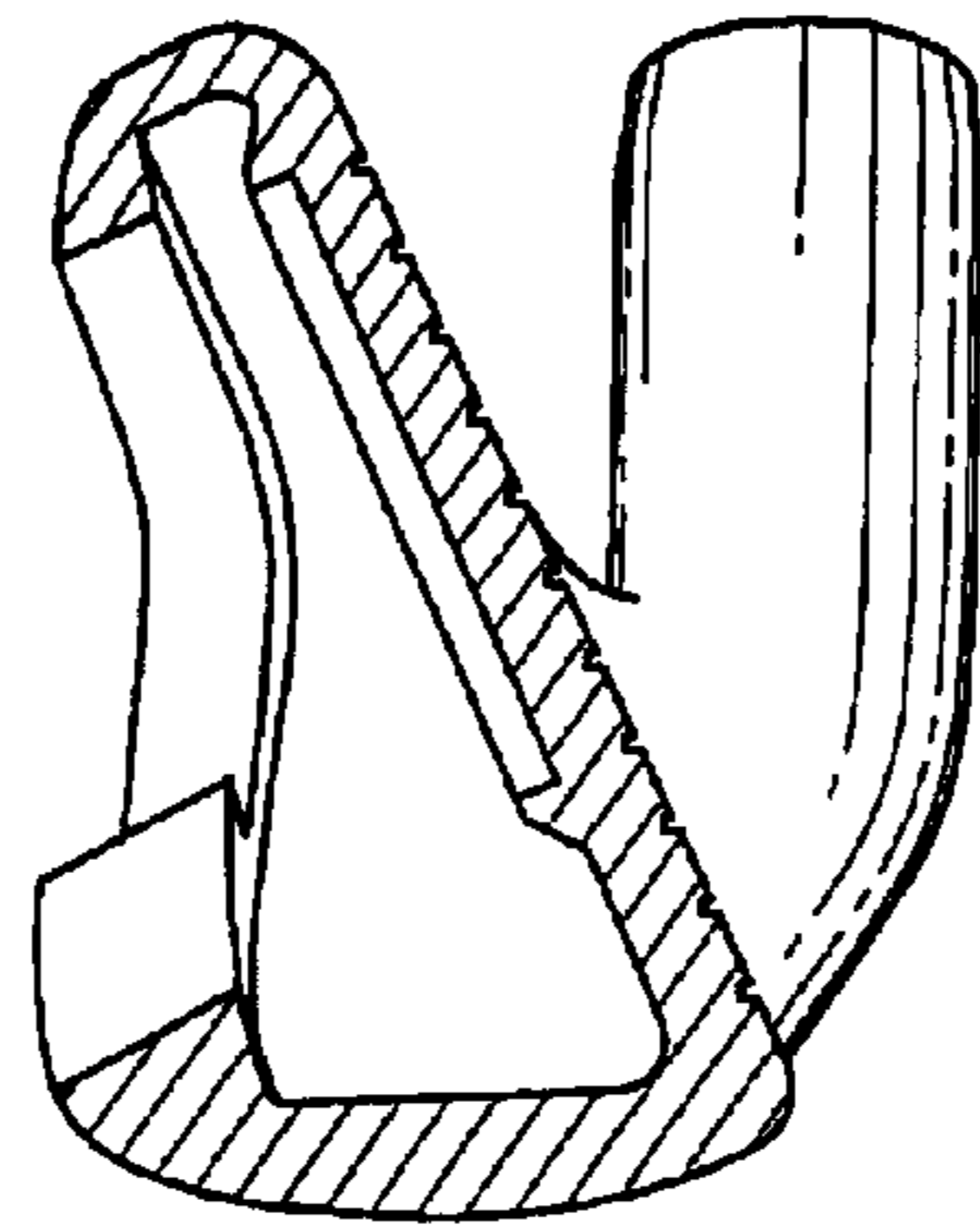

FIG. 3

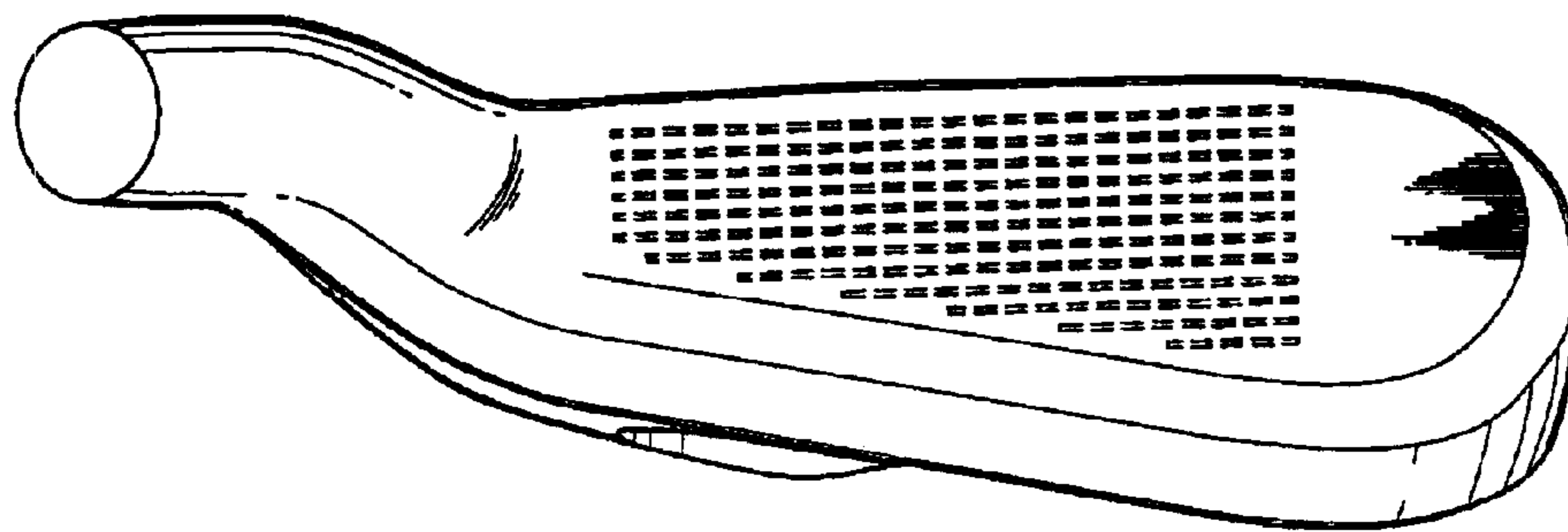

FIG. 4

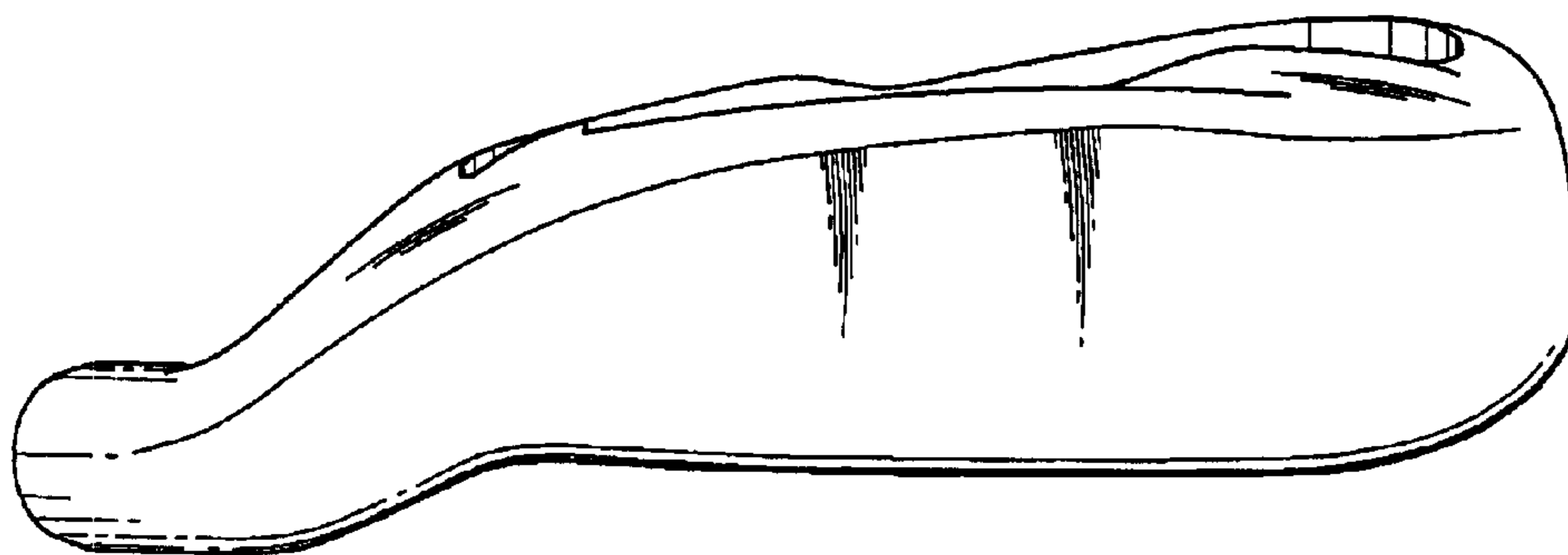

FIG. 5

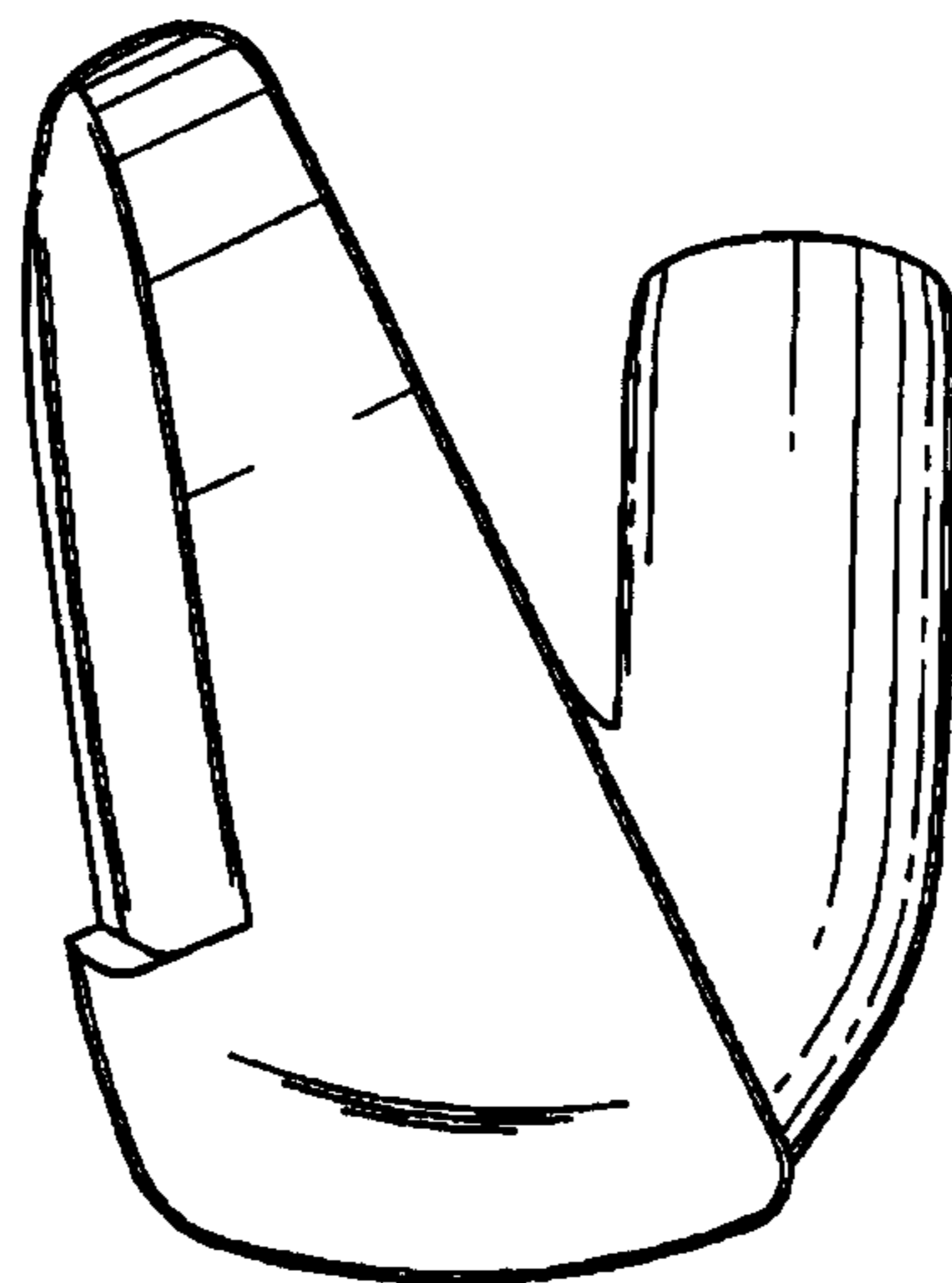

FIG. 6

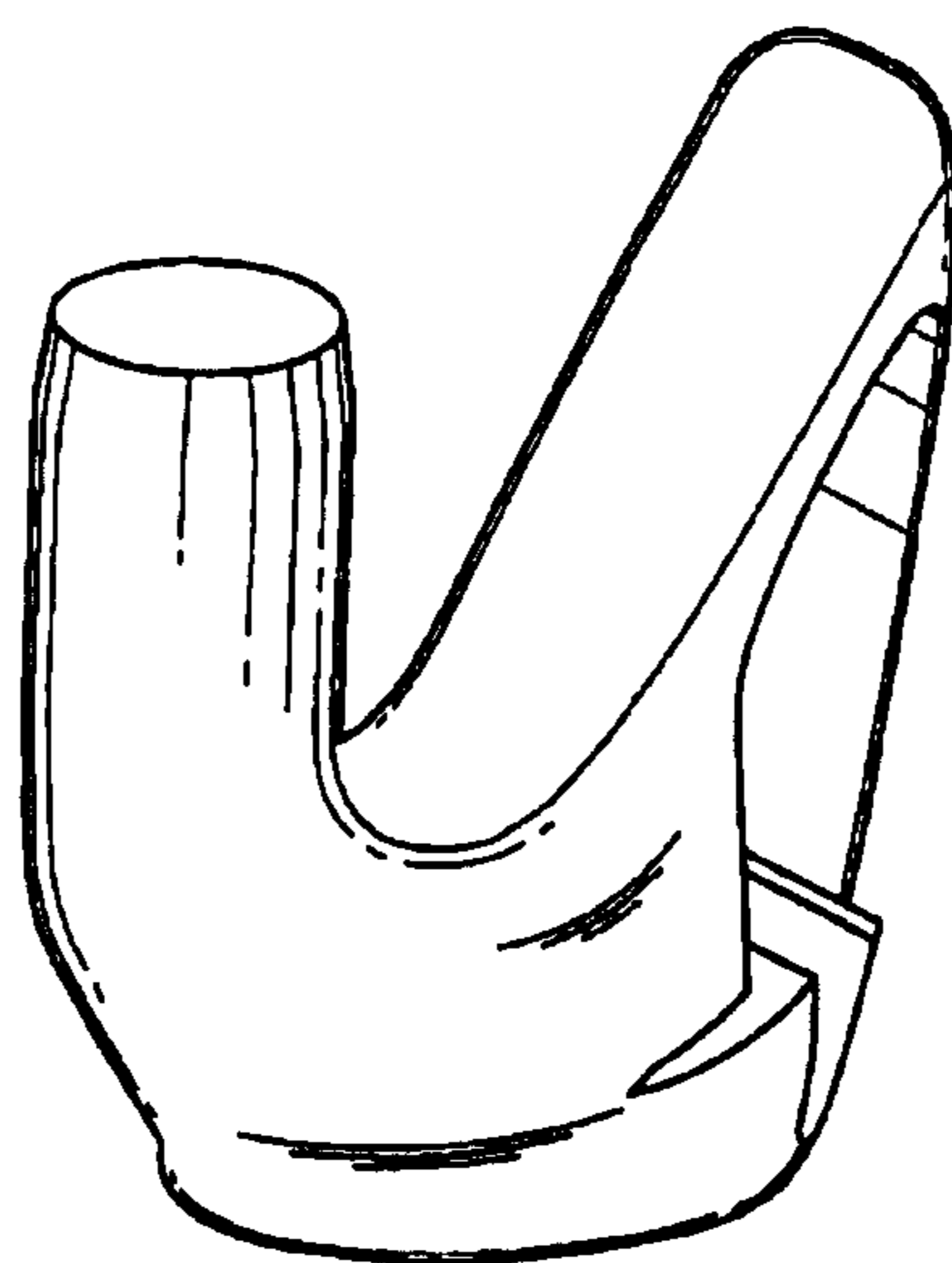

FIG. 7