



US00D544010S

(12) **United States Design Patent**
Martin

(10) **Patent No.:** **US D544,010 S**
(45) **Date of Patent:** **** Jun. 5, 2007**

(54) **COMBINED CAMERA AND CLOCK**

FOREIGN PATENT DOCUMENTS

(75) Inventor: **Mark G. Martin**, Monrovia, CA (US)

JP 02003228117 A * 8/2003

* cited by examiner

(73) Assignee: **Sharper Image Corporation**, San Francisco, CA (US)

Primary Examiner—Ian Simmons

Assistant Examiner—W. Laymon

(74) *Attorney, Agent, or Firm*—Bell, Boyd & Lloyd, LLP

(**) Term: **14 Years**

(57) **CLAIM**

(21) Appl. No.: **29/216,196**

The ornamental design for a combined camera and clock, as shown and described.

(22) Filed: **Oct. 28, 2004**

(51) **LOC (8) Cl.** **16-01**

DESCRIPTION

(52) **U.S. Cl.** **D16/208; D16/200; D16/208; D16/219**

FIG. 1 is a front perspective view of a combined camera and clock, showing my new design;

(58) **Field of Classification Search** D16/200–206, D16/208, 219; D10/2, 3, 15, 24–26; 348/373–376; 358/909.1; 396/427, 535–541

FIG. 2 is a rear perspective view thereof;

FIG. 3 is a front view thereof;

See application file for complete search history.

FIG. 4 is a rear view thereof;

FIG. 5 is a right side view thereof;

(56) **References Cited**

U.S. PATENT DOCUMENTS

FIG. 6 is a left side view thereof;

FIG. 7 is a top view thereof; and,

FIG. 8 is a bottom view thereof.

D273,683 S * 5/1984 Hendren et al. D16/208

D442,210 S * 5/2001 Chan D10/2

D443,523 S * 6/2001 Duke D10/15

D496,678 S * 9/2004 Kawase D16/202

The broken lines in FIGS. 1 to 8 are for illustrative purposes only and form no part of the claimed design.

1 Claim, 4 Drawing Sheets

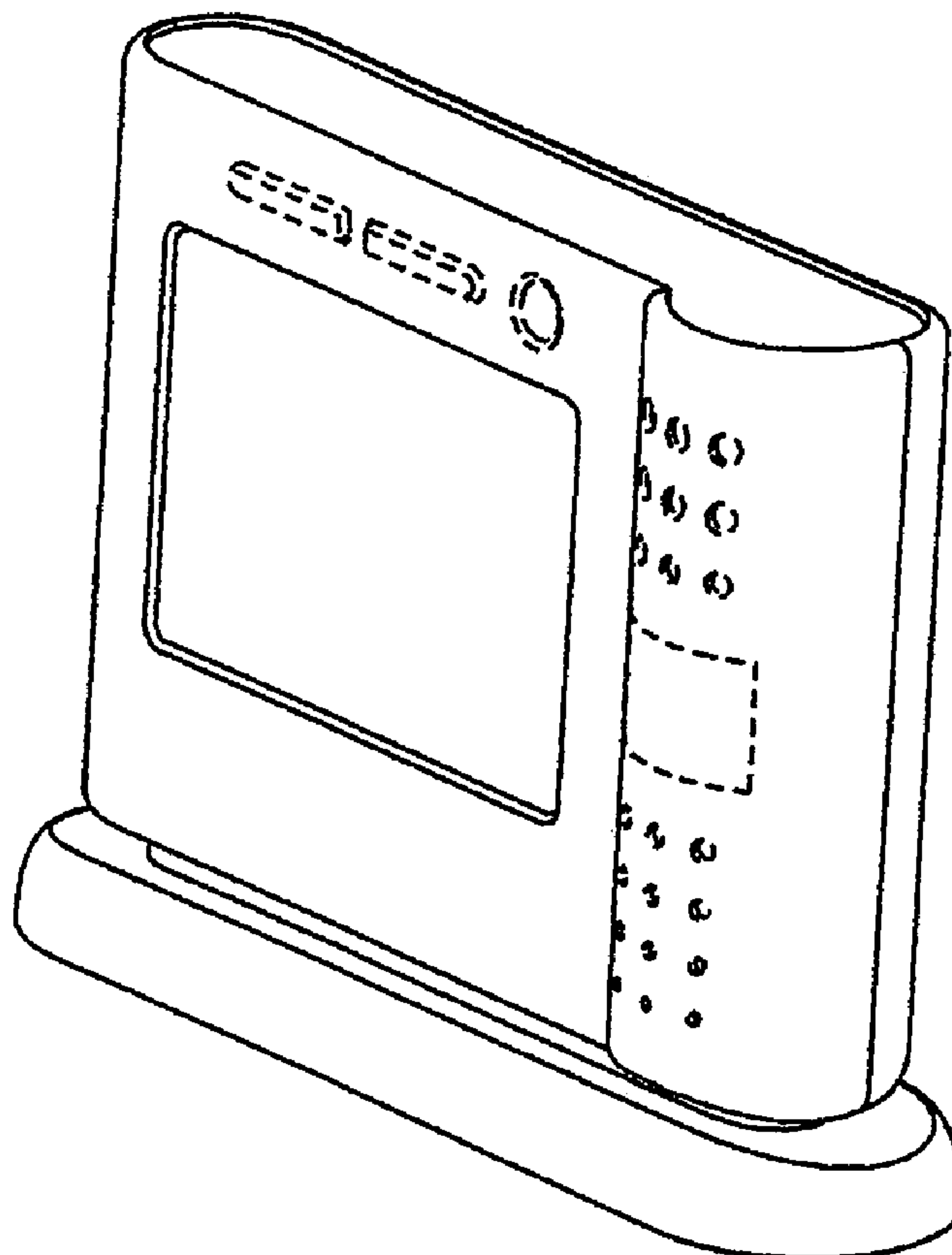

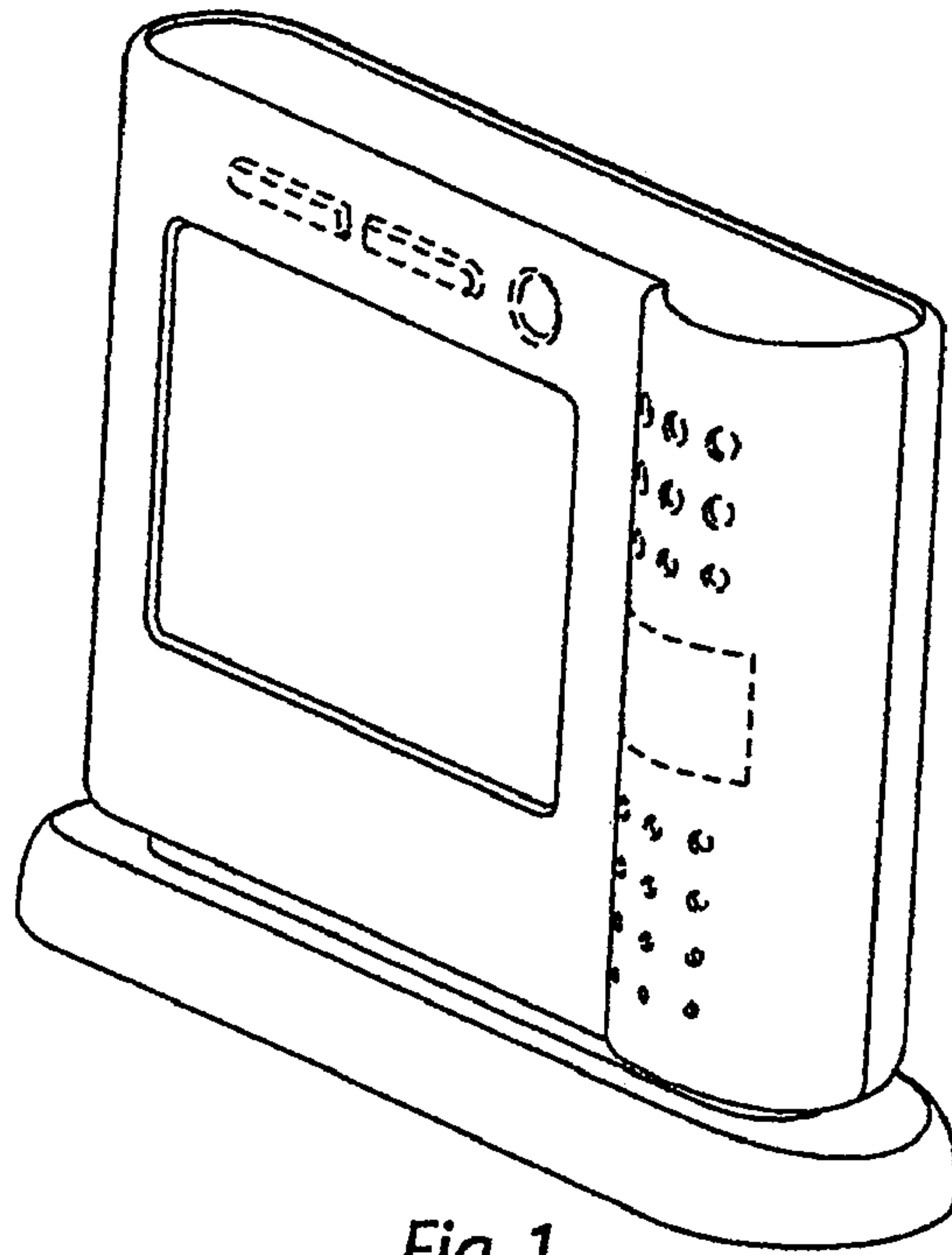

Fig. 1

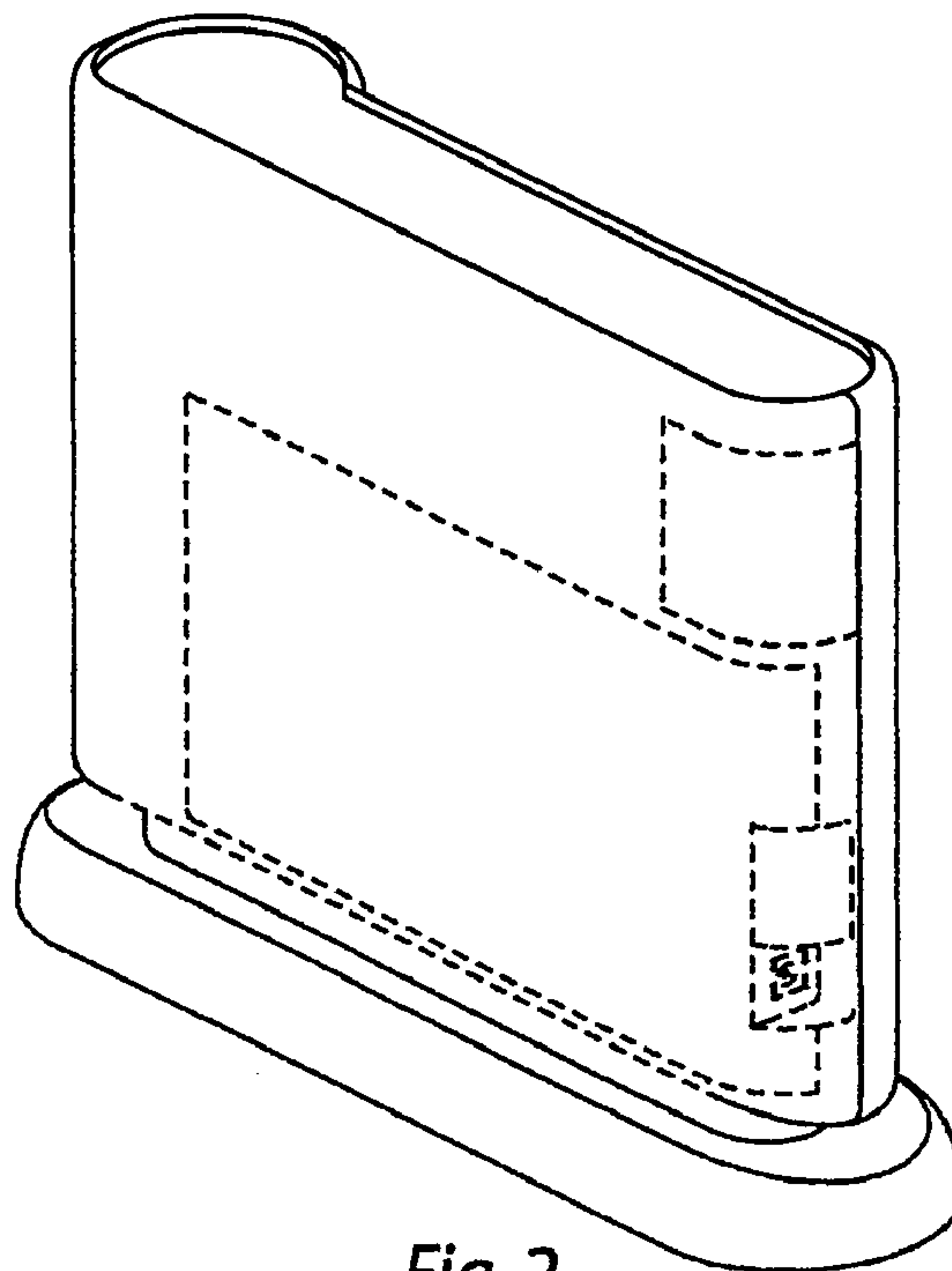

Fig. 2

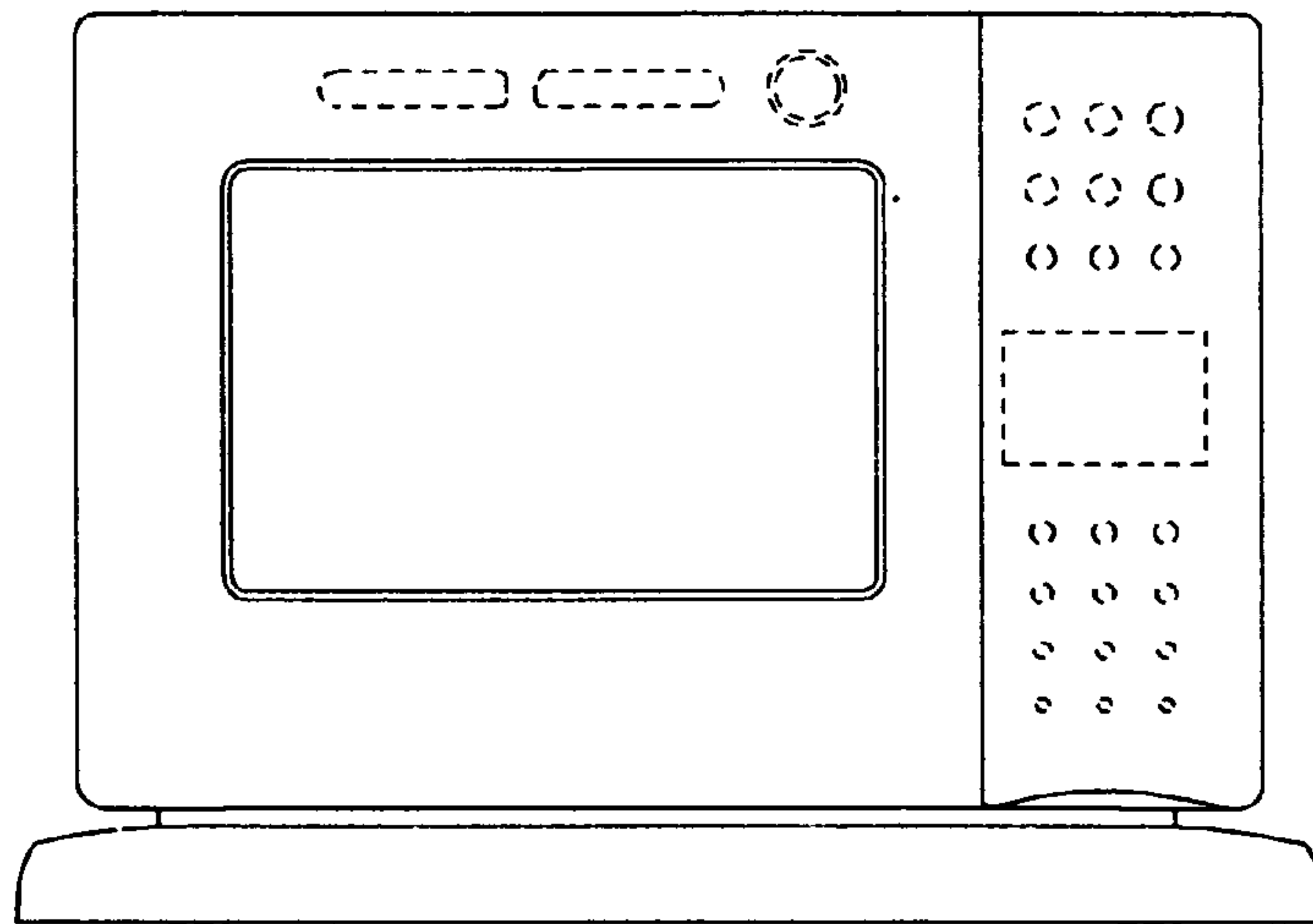

Fig. 3

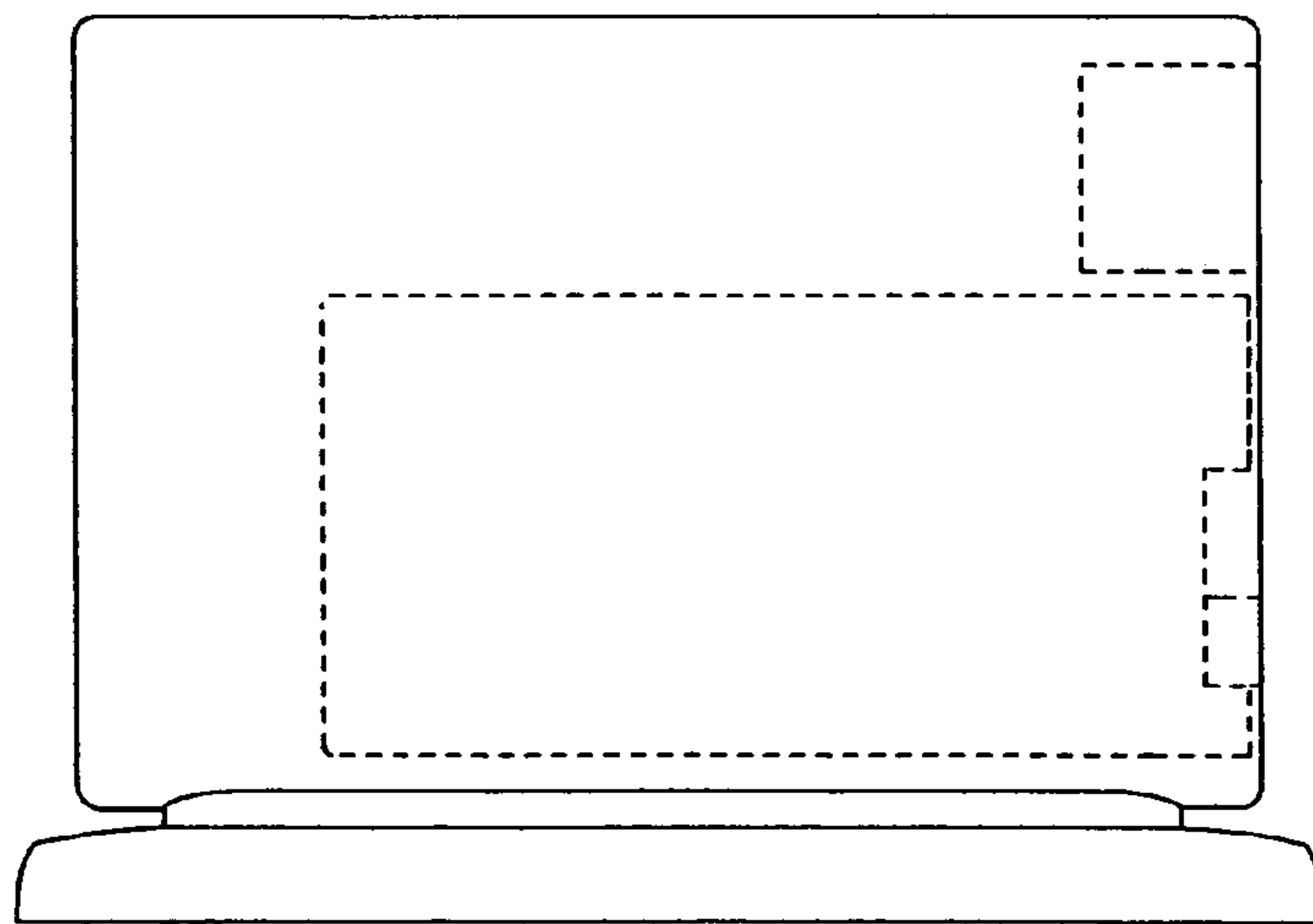

Fig. 4

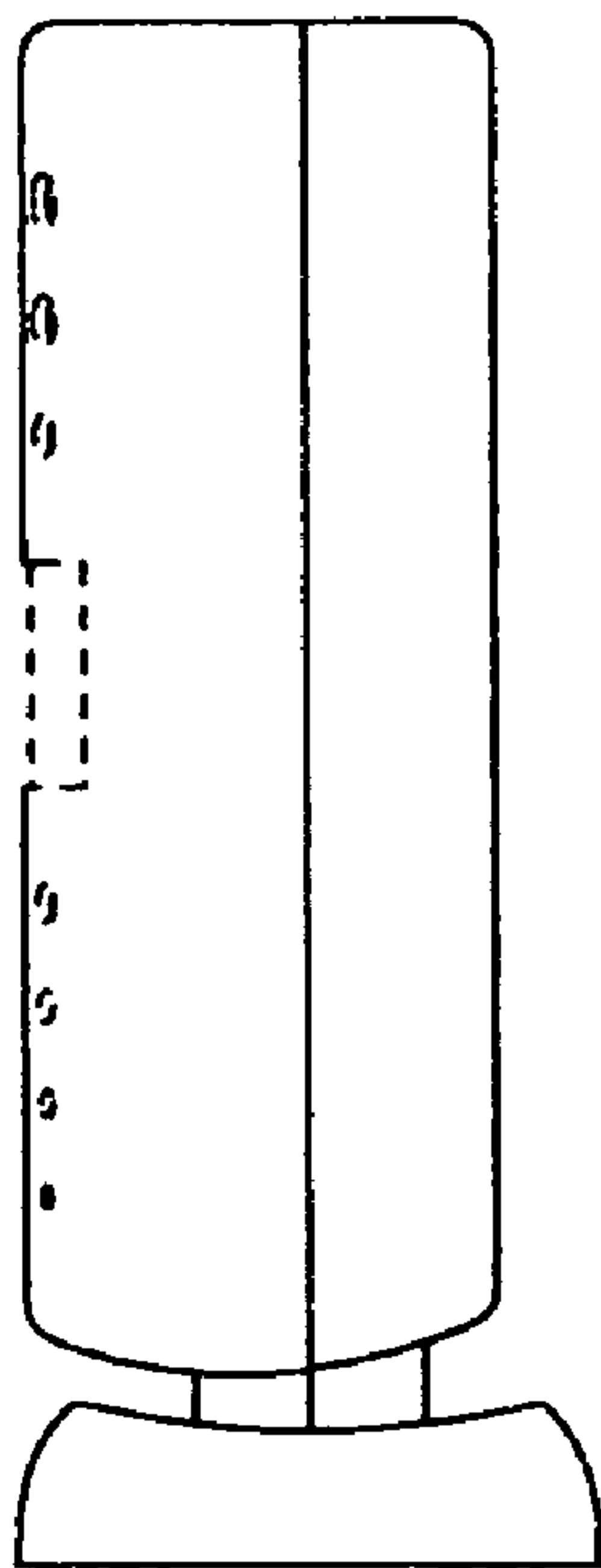

Fig. 5

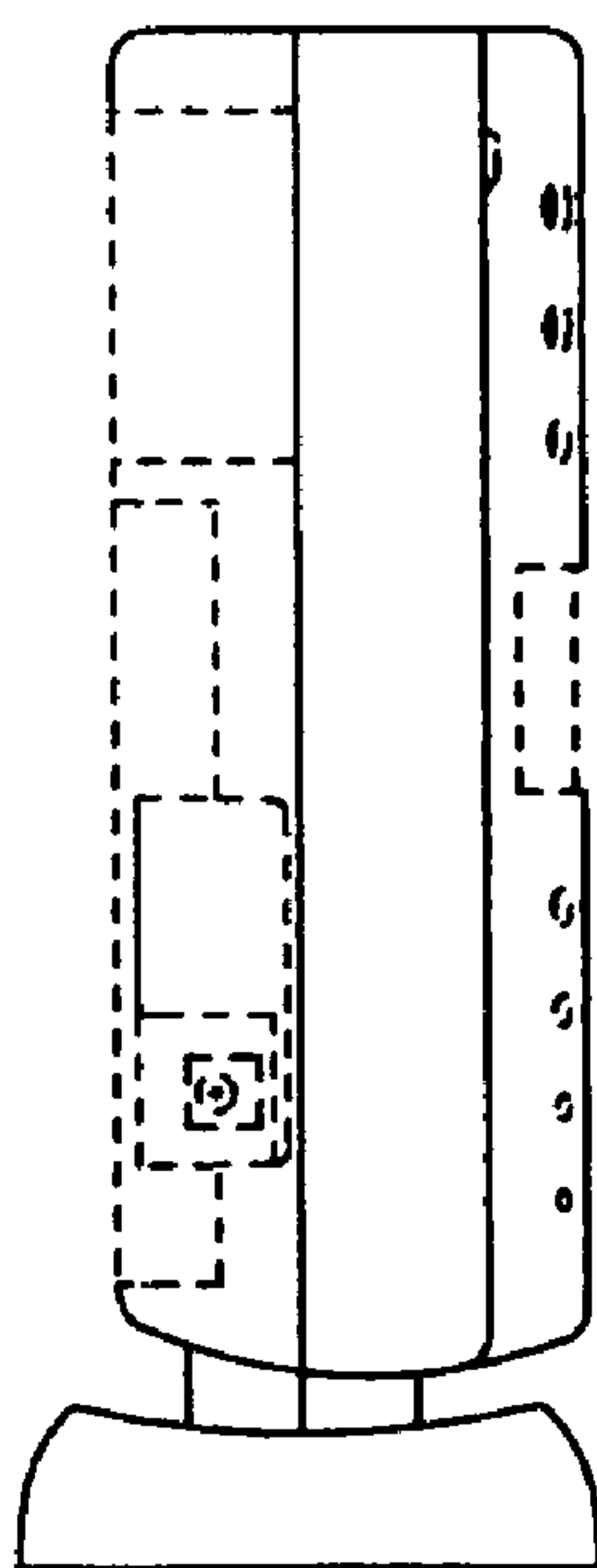

Fig. 6

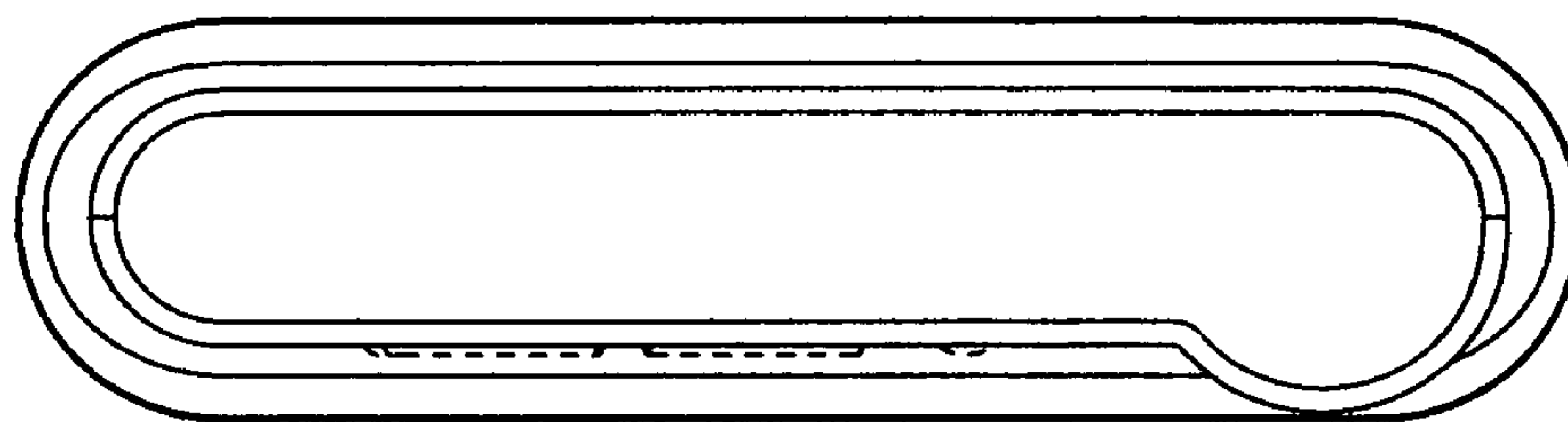

Fig. 7

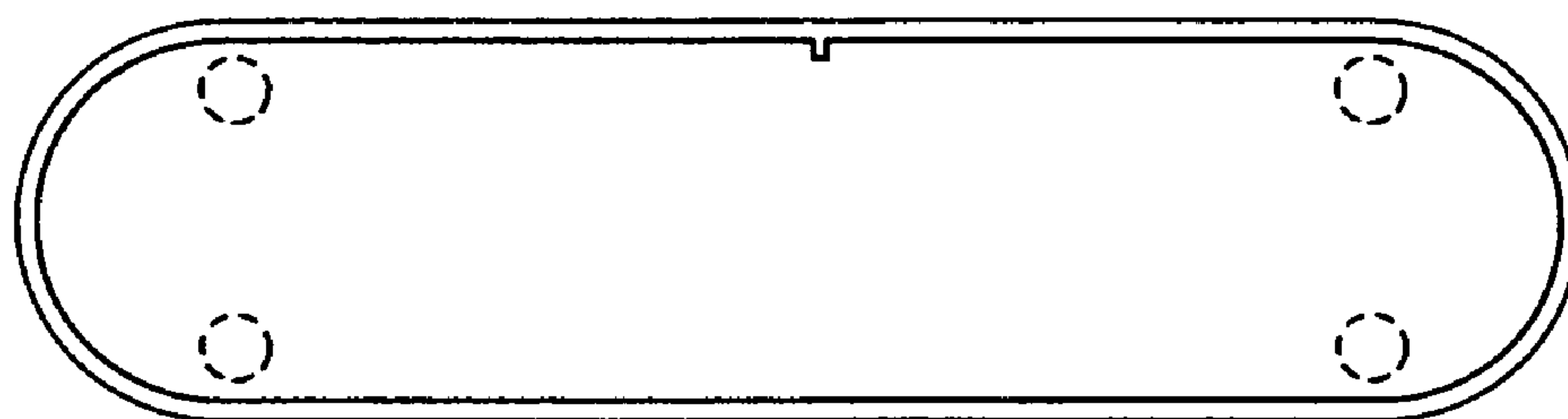

Fig. 8