



US00D543958S

(12) **United States Design Patent**
Wu

(10) **Patent No.:** **US D543,958 S**
(45) **Date of Patent:** **** Jun. 5, 2007**

(54) **FLAT PANEL TV**
(75) Inventor: **Yii-Hong Wu**, Padeh (TW)
(73) Assignee: **Chunghwa Picture Tubes, Ltd.**, Padeh, Taoyuan (TW)
(**) Term: **14 Years**

(21) Appl. No.: **29/223,308**

(22) Filed: **Feb. 11, 2005**

(51) **LOC (8) Cl.** **14-03**

(52) **U.S. Cl.** **D14/126**

(58) **Field of Classification Search** D14/125-135,
D14/239, 379, 371, 374, 375, 376, 113; D13/151,
D13/153; 312/7.2; 348/836, 838, 180, 184,
348/325, 739; 341/12; 248/917-924; 345/104,
345/133, 156, 168, 87, 173; 349/1, 2, 11,
349/62

See application file for complete search history.

(56) **References Cited**

U.S. PATENT DOCUMENTS

D417,659 S * 12/1999 Takemasa D14/374
D441,732 S * 5/2001 Ota D14/126
D454,845 S * 3/2002 Niitsu D14/126
D458,236 S * 6/2002 Bong et al. D14/126
D458,237 S * 6/2002 Niitsu D14/126
D479,209 S * 9/2003 Teng et al. D14/126

D492,270 S * 6/2004 Natori et al. D14/126
D494,148 S * 8/2004 Huang et al. D14/126
D494,149 S * 8/2004 Shih D14/126
D497,352 S * 10/2004 Asanuma et al. D14/126
D497,627 S * 10/2004 Inaba D16/326

OTHER PUBLICATIONS

eCost.com 2003 catalog p. 35.*

* cited by examiner

Primary Examiner—Raphael Barkai

Assistant Examiner—Randall H. Gholson

(74) *Attorney, Agent, or Firm*—Tim Tingkang Xia, Esq.;
Morris Manning Martin LLP

(57) **CLAIM**

The ornamental design for a flat panel TV, as shown and described.

DESCRIPTION

FIG. 1 is a three-dimensional view of a flat panel TV showing my new design:

FIG. 2 is a front view thereof;

FIG. 3 is a rear view thereof;

FIG. 4 is a left side view thereof;

FIG. 5 is a right side view thereof;

FIG. 6 is a top view thereof; and,

FIG. 7 is a bottom view thereof.

1 Claim, 7 Drawing Sheets

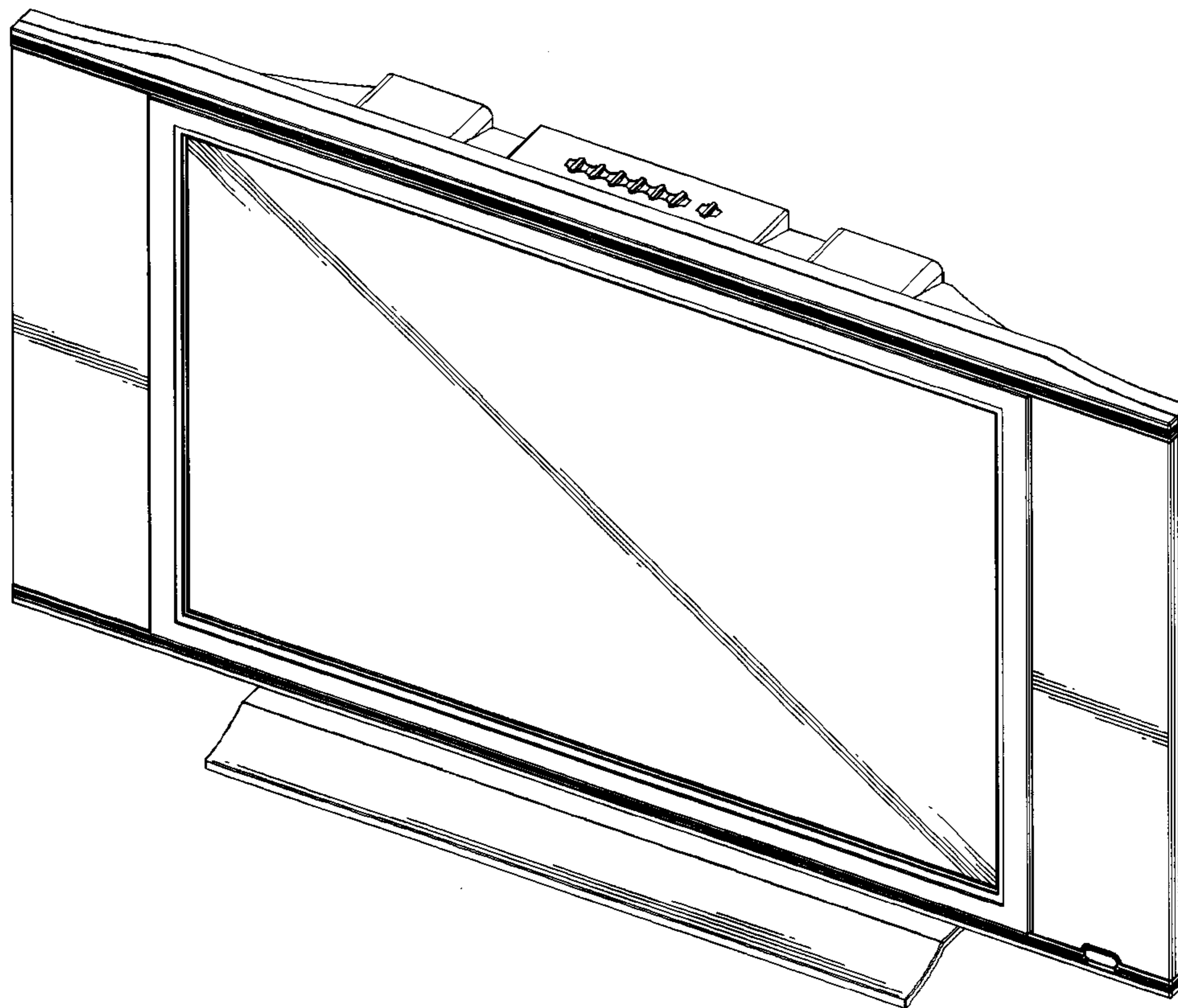

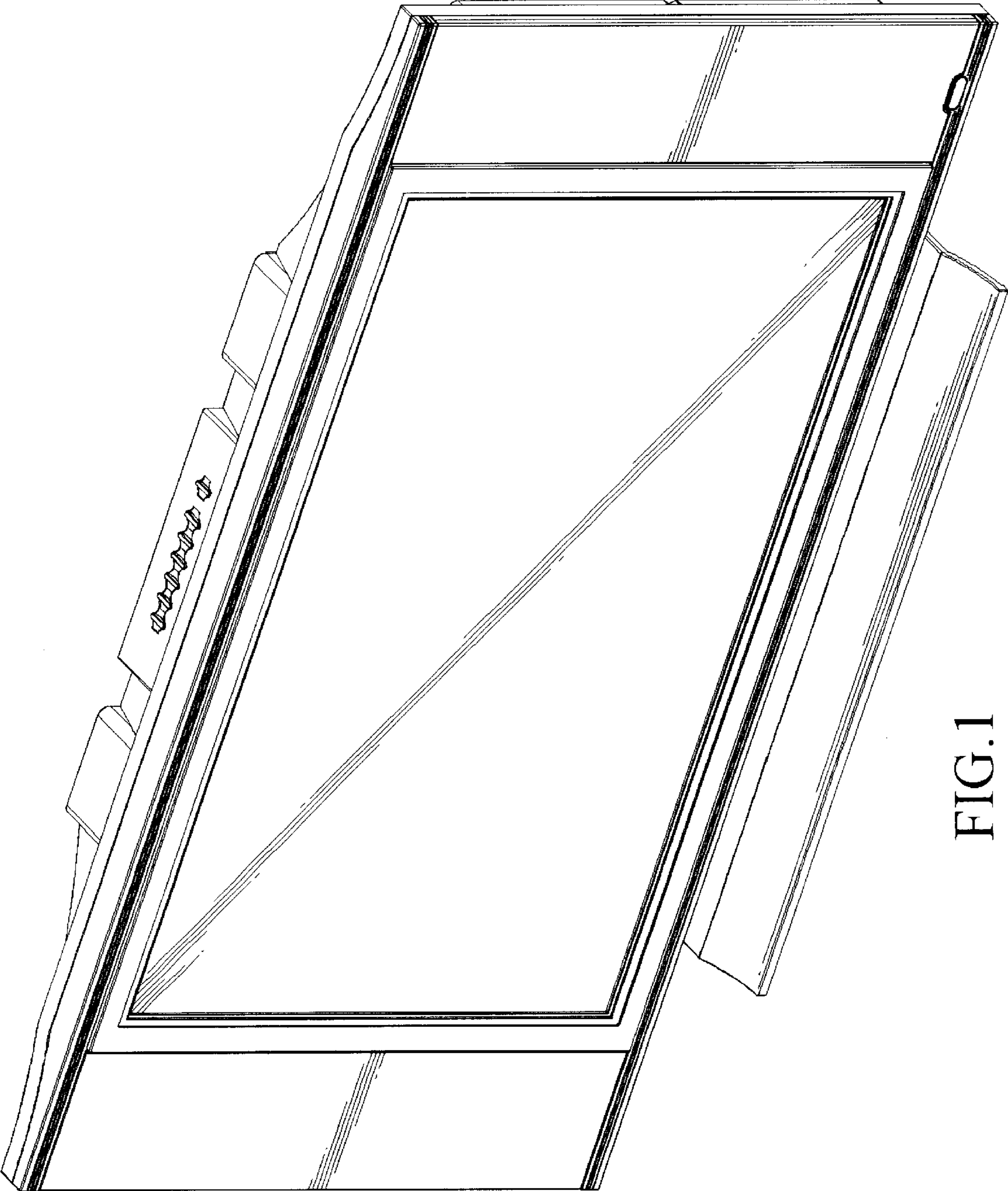

FIG.1

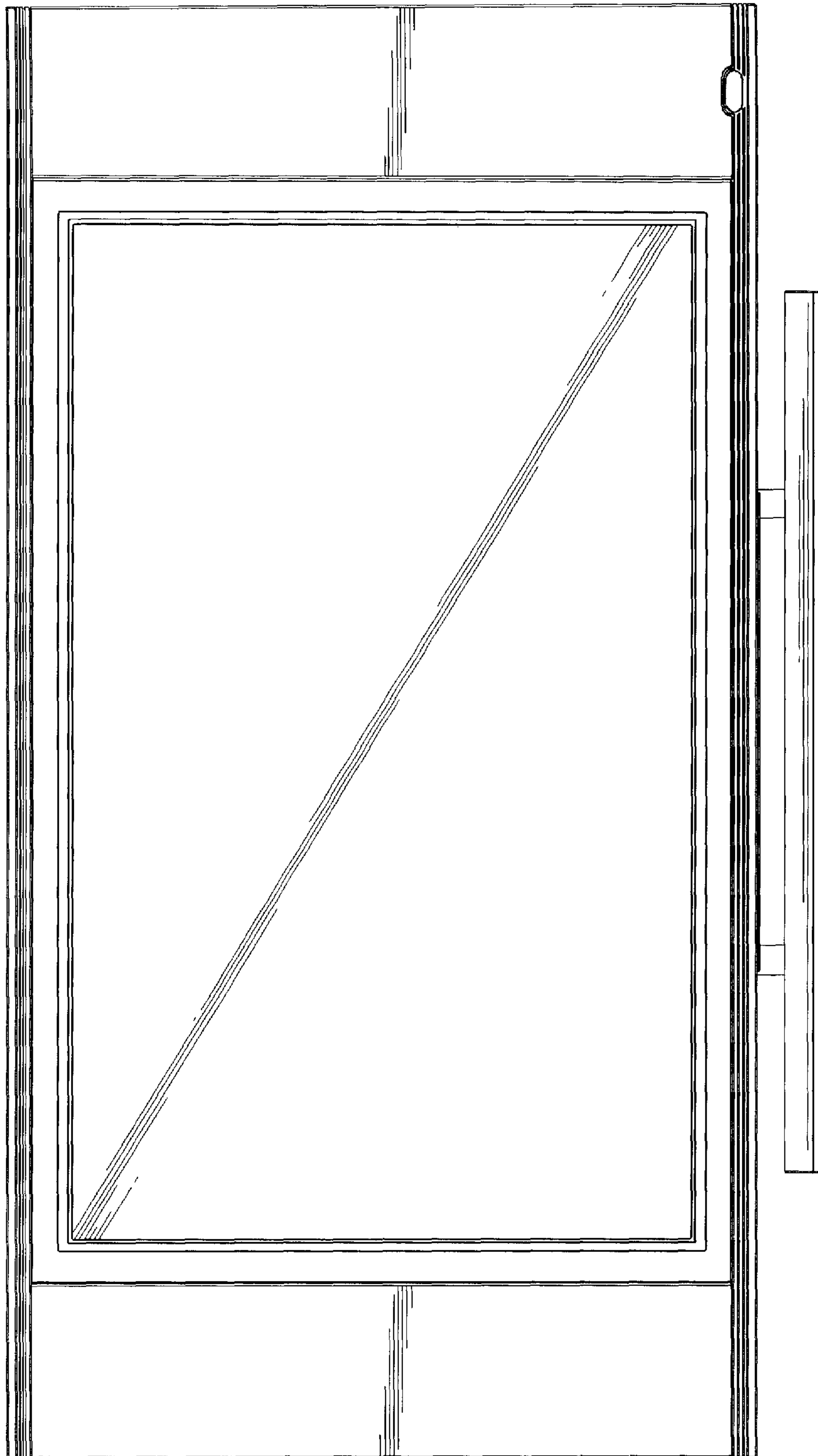

FIG.2

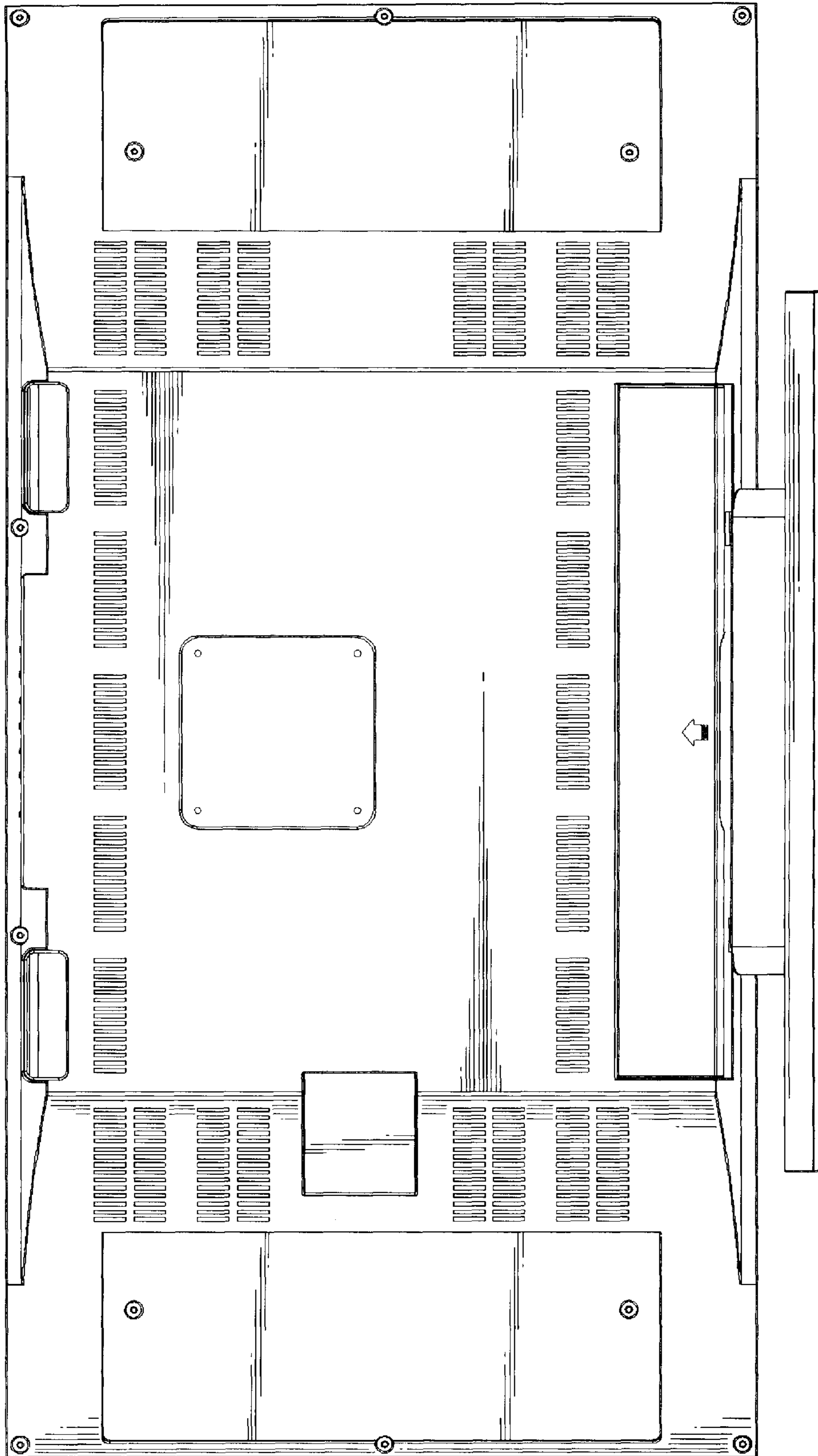

FIG.3

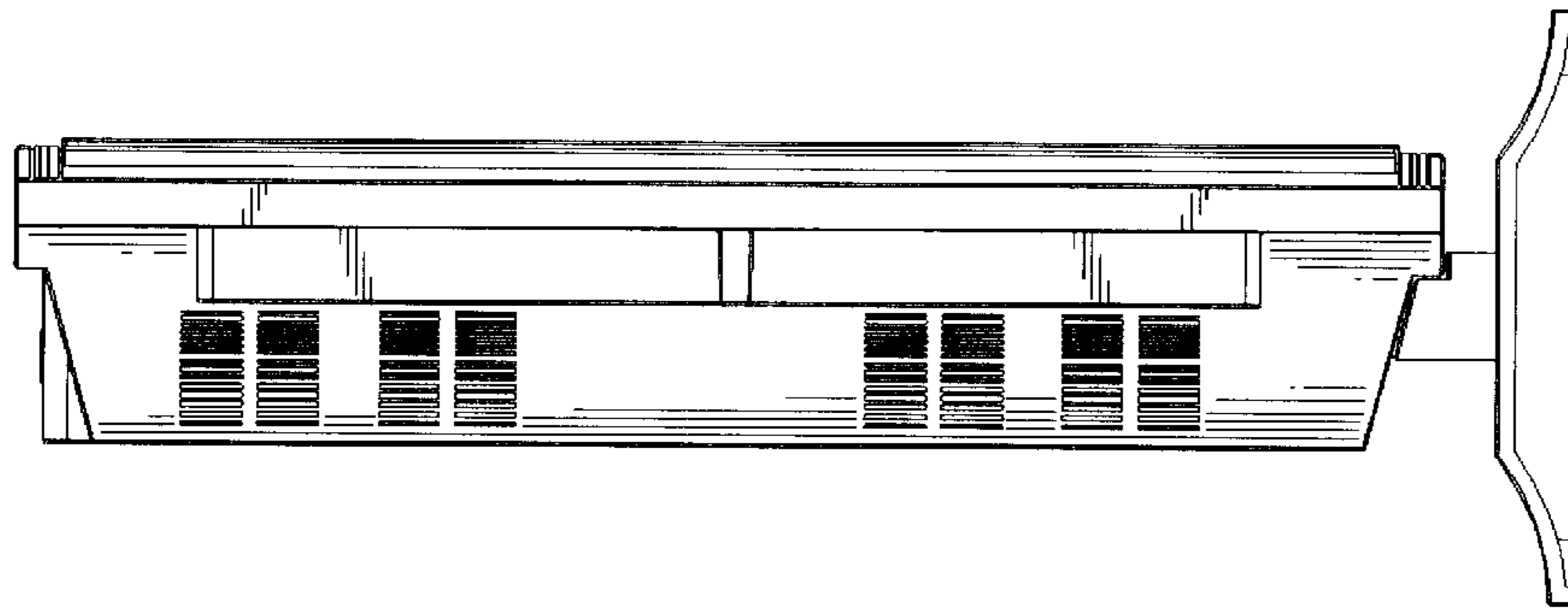

FIG.4

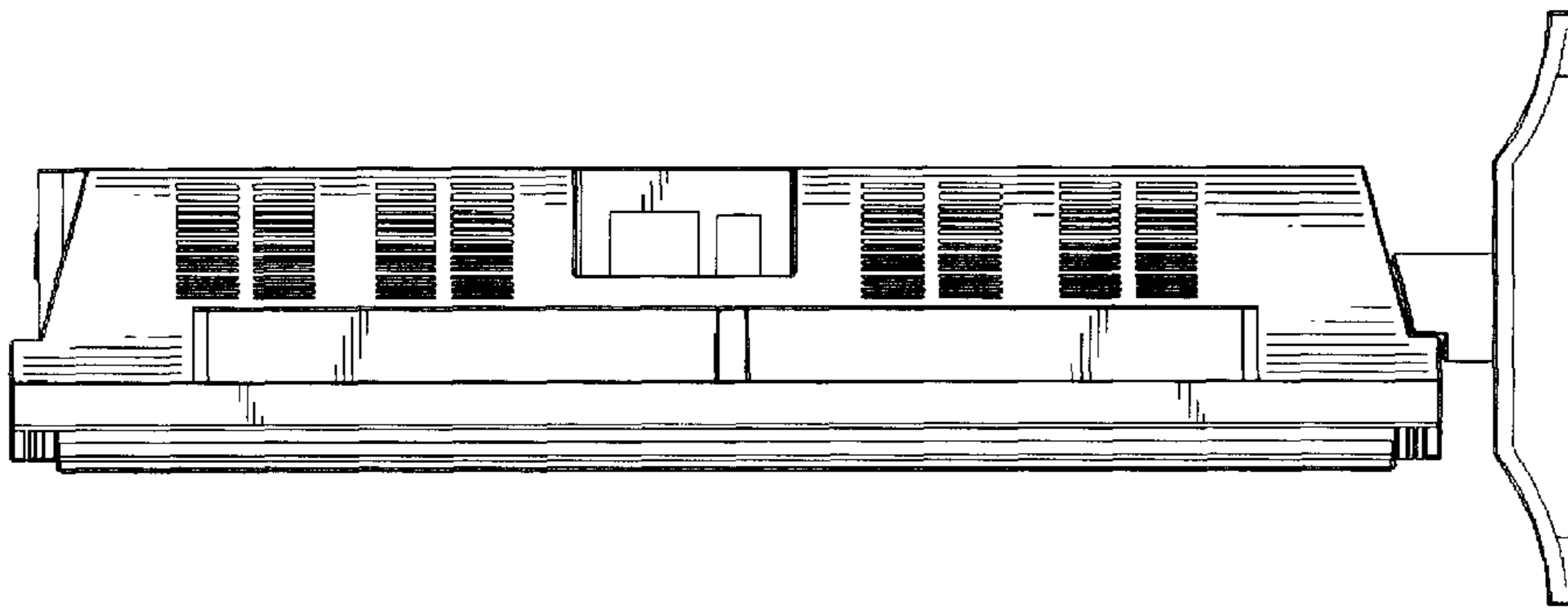

FIG. 5

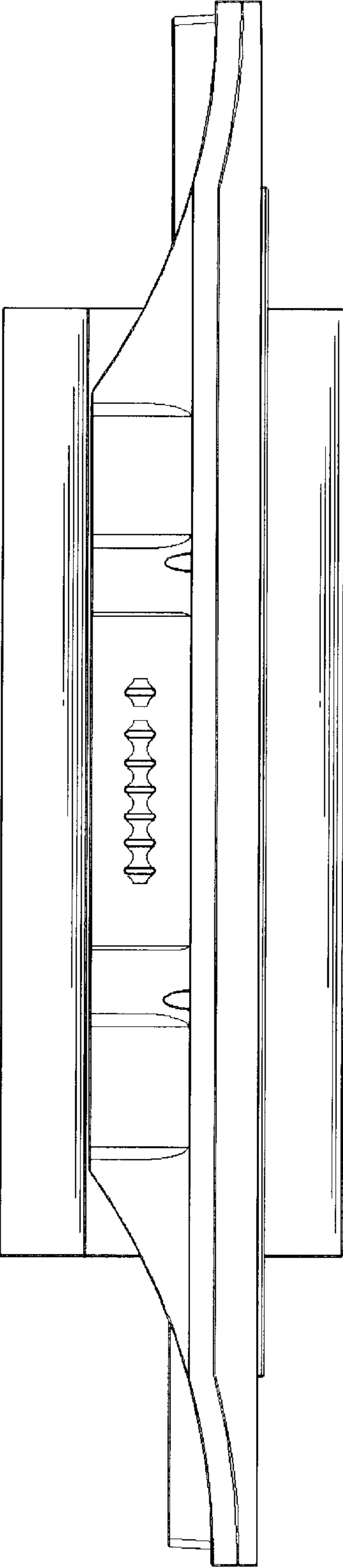

FIG. 6

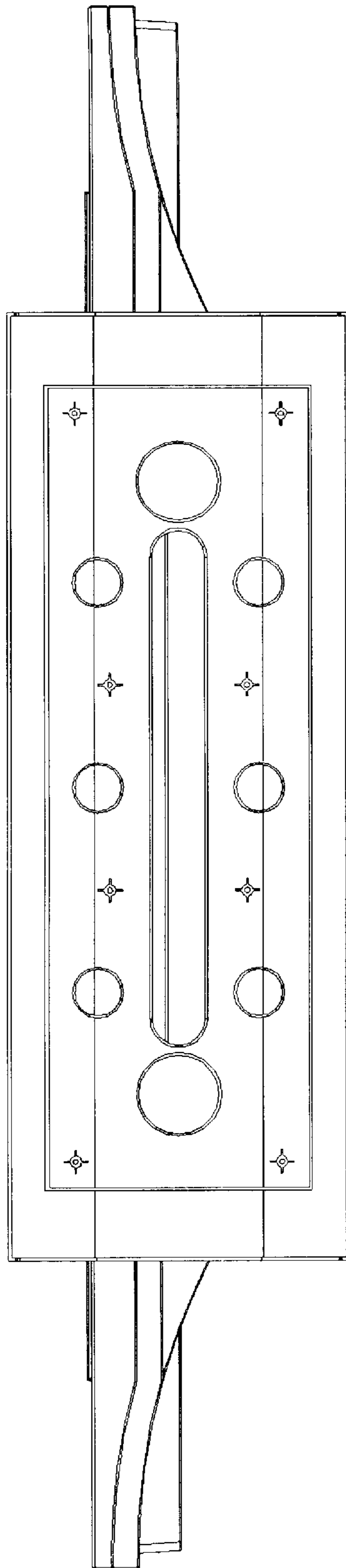

FIG.7