



US00D543952S

(12) **United States Design Patent**  
**Wu et al.**

(10) **Patent No.:** **US D543,952 S**

(45) **Date of Patent:** **\*\* Jun. 5, 2007**

(54) **REMOTE CONTROLLER**

(75) Inventors: **Chun-An Wu**, Taipei (TW);  
**Chih-Rong Yang**, Taipei (TW)

(73) Assignee: **Giga-Byte Technology Co., Ltd.**,  
Taipei (TW)

(\*\*) Term: **14 Years**

(21) Appl. No.: **29/233,634**

(22) Filed: **Jul. 6, 2005**

(51) **LOC (8) Cl.** ..... **13-03**

(52) **U.S. Cl.** ..... **D13/168**

(58) **Field of Classification Search** ..... 345/156,  
345/168, 169, 184; 348/734; 455/92, 95,  
455/100, 128, 151.1–151.4, 325–355; 463/39,  
463/36, 38; 700/17, 19, 20, 281; D21/333,  
D21/385; D13/168; D10/104, 106; D14/218,  
D14/247, 401; 340/825.22, 825.24, 825.25,  
340/825.31, 825.36, 825.69, 825.71, 825.72;  
341/20, 22, 23, 34, 173, 174, 176

See application file for complete search history.

(56) **References Cited**

**U.S. PATENT DOCUMENTS**

- 5,207,426 A \* 5/1993 Inoue et al. .... 463/36
- D354,316 S \* 1/1995 Hiraoka ..... D14/401
- D381,961 S \* 8/1997 Watanabe et al. .... D13/168
- D397,164 S \* 8/1998 Goto ..... D21/385

- 5,949,401 A \* 9/1999 Kazarian ..... 345/156
- D456,854 S \* 5/2002 Ashida ..... D21/333
- 6,402,616 B1 \* 6/2002 Ogata et al. .... 463/37

\* cited by examiner

*Primary Examiner*—Selina Sikder

(74) *Attorney, Agent, or Firm*—Andrew D. Fortney

(57) **CLAIM**

The ornamental design for a remote controller, as shown and described.

**DESCRIPTION**

FIG. 1 is a perspective view of a remote controller showing our design;  
 FIG. 2 is a front elevational view thereof;  
 FIG. 3 is a rear elevational view thereof;  
 FIG. 4 is a left side elevational view thereof;  
 FIG. 5 is a right side elevational view thereof;  
 FIG. 6 is a top plan view thereof;  
 FIG. 7 is a bottom plan view thereof;  
 FIG. 8 is another perspective view of FIG. 1 wherein the handles are shown and in open position;  
 FIG. 9 is a front elevational view of FIG. 8;  
 FIG. 10 is a rear elevational view of FIG. 8;  
 FIG. 11 is a right side elevational view of FIG. 8;  
 FIG. 12 is a left side elevational view of FIG. 8;  
 FIG. 13 is a top plan view of FIG. 8; and,  
 FIG. 14 is a bottom plan view of FIG. 8.

**1 Claim, 14 Drawing Sheets**

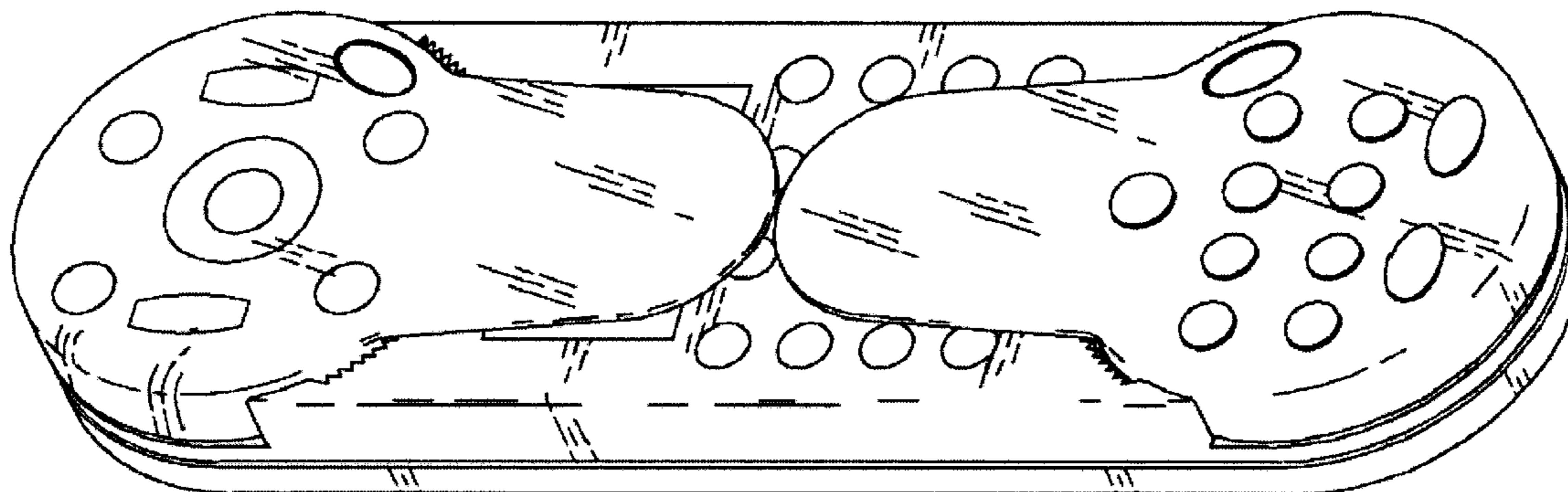

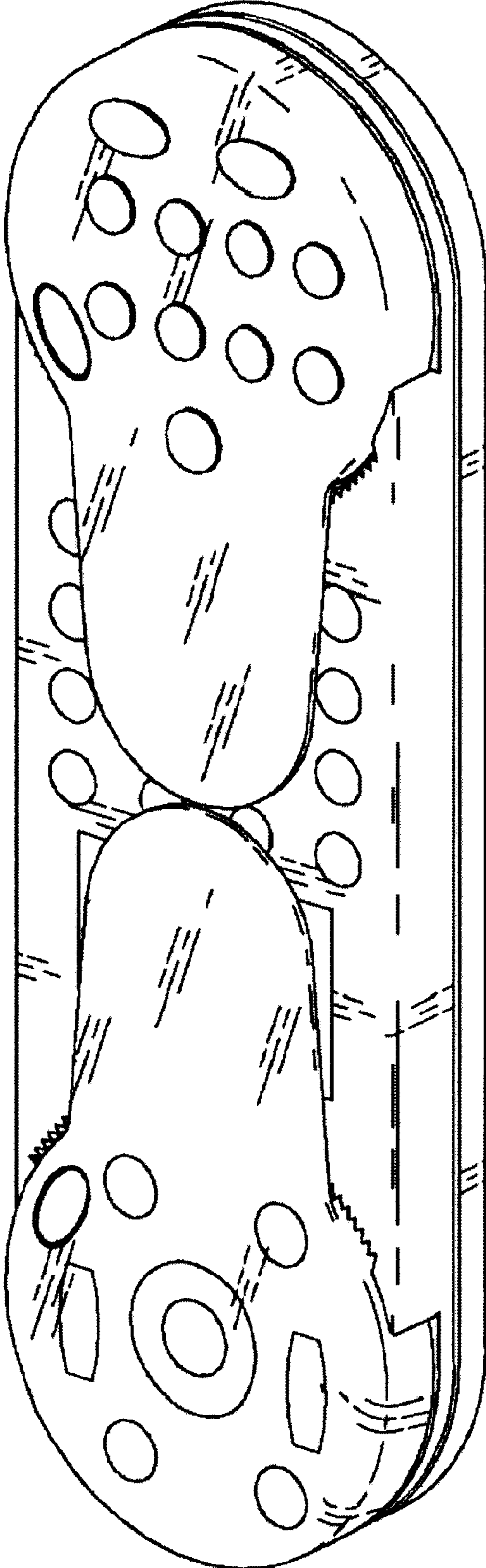

FIG. 1

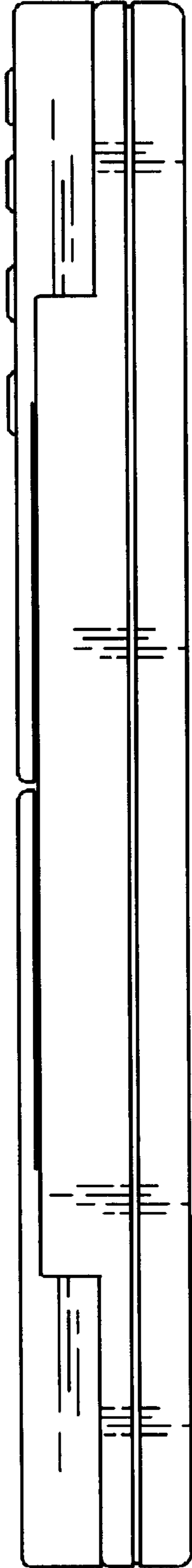

FIG. 2

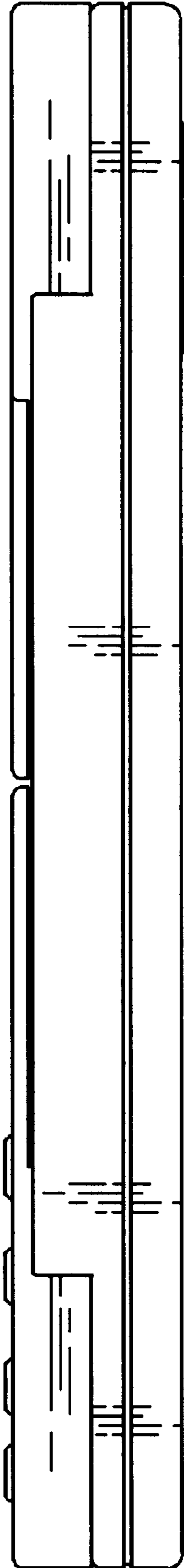

FIG. 3

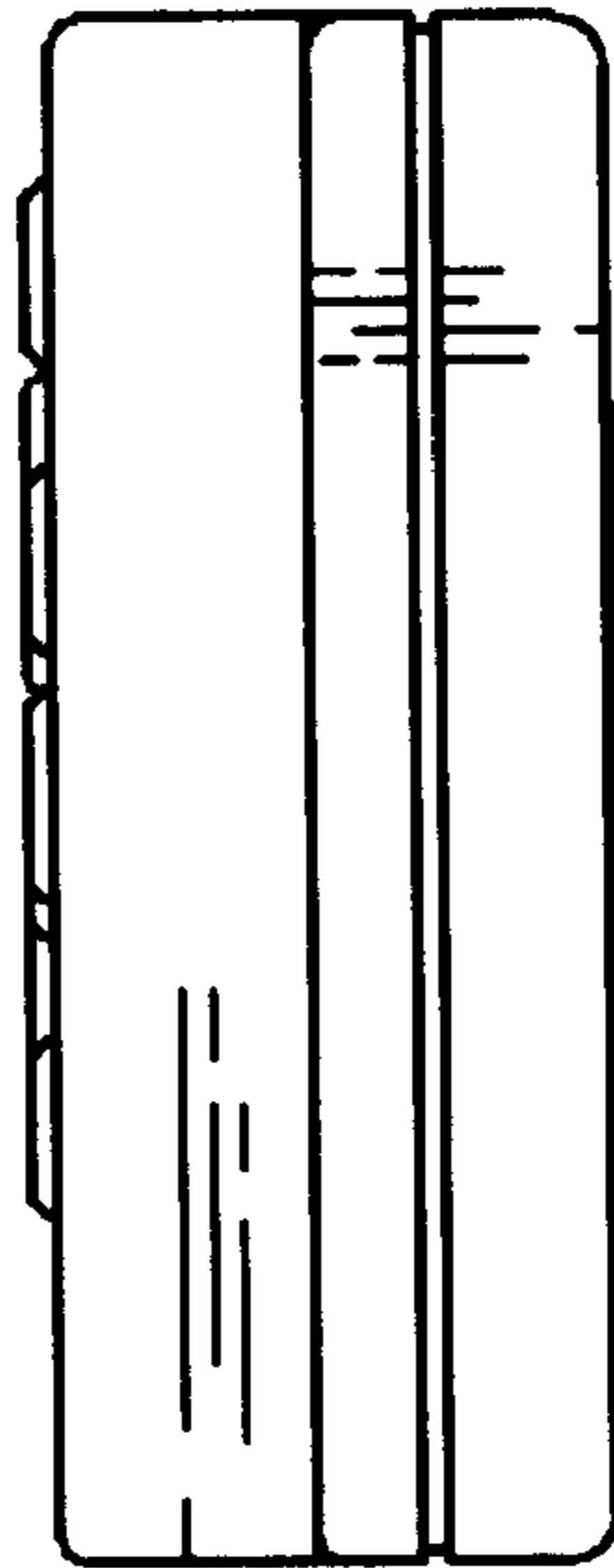

FIG. 4

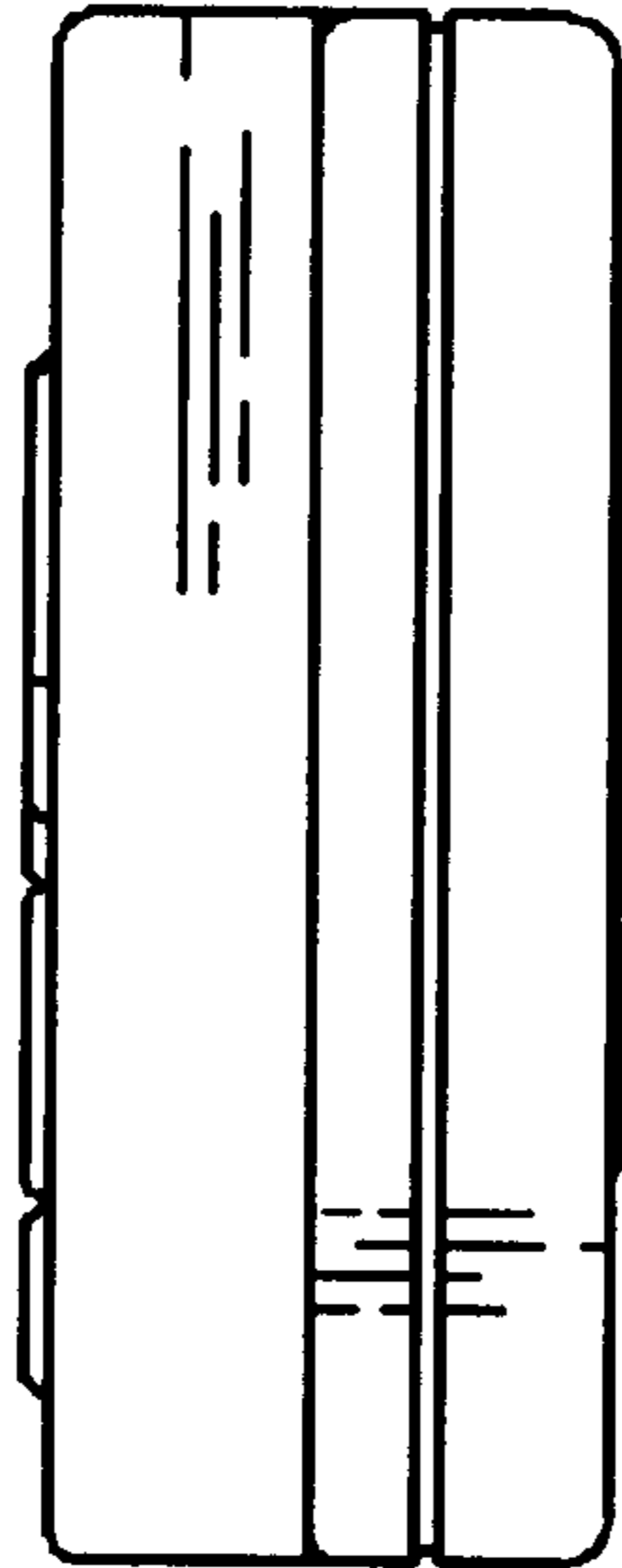

FIG. 5

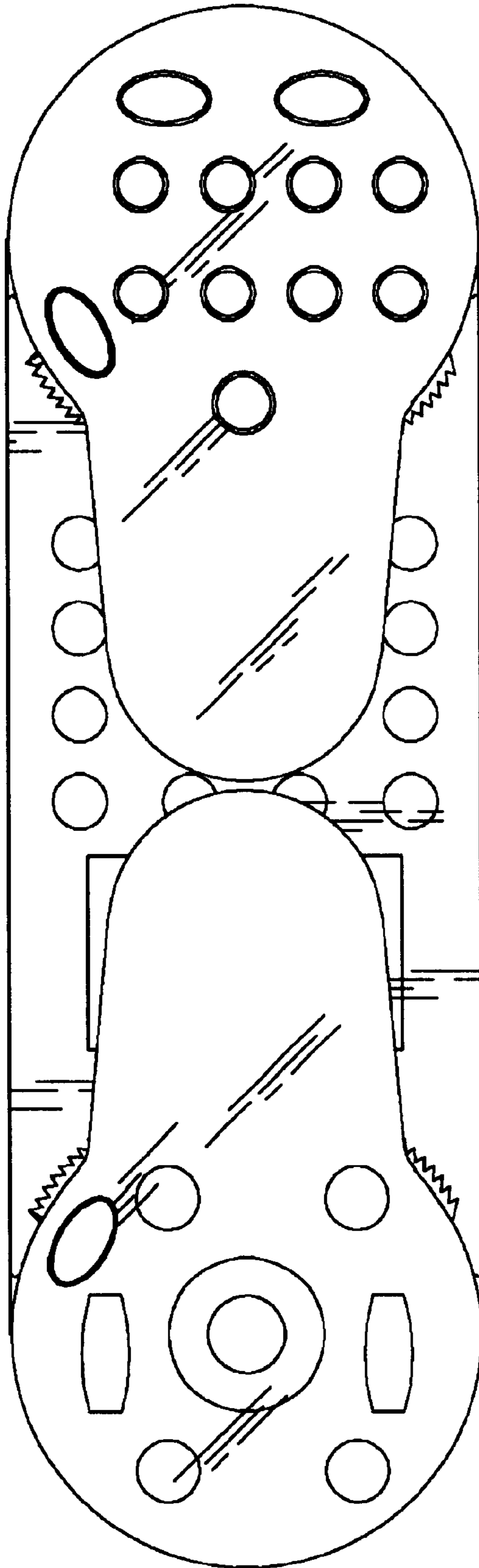

FIG. 6

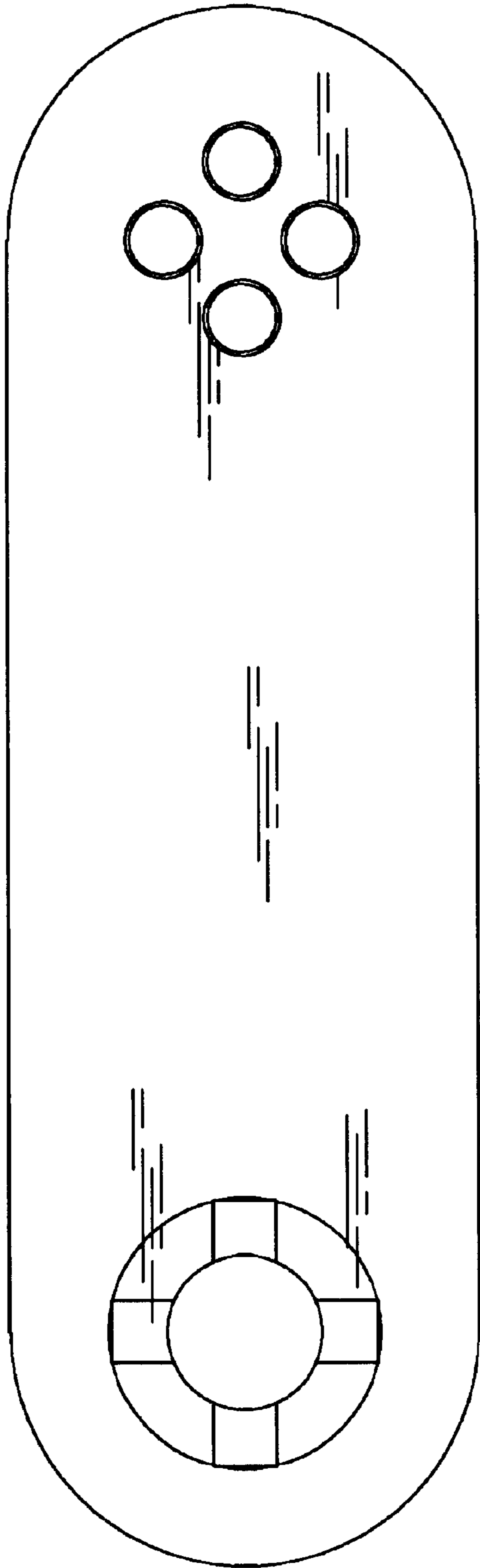

FIG. 7



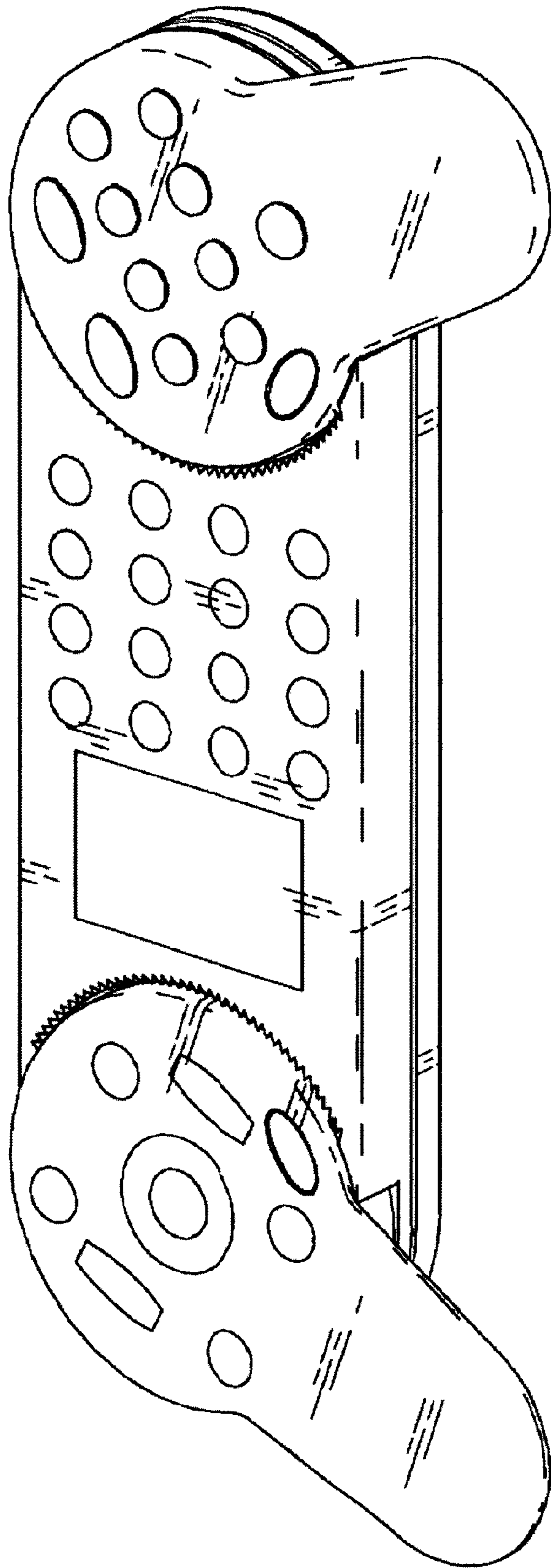

FIG. 8

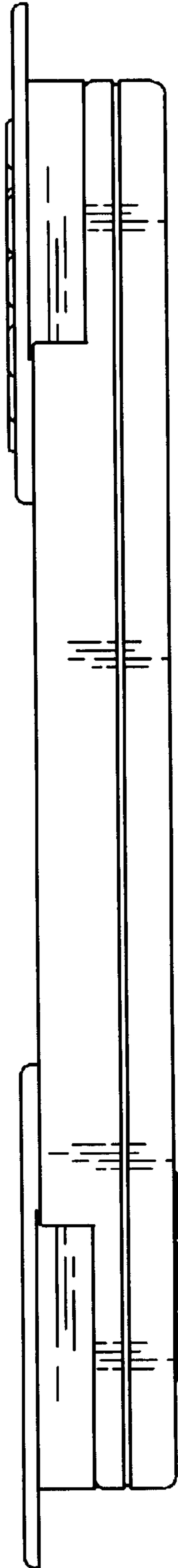

FIG. 9

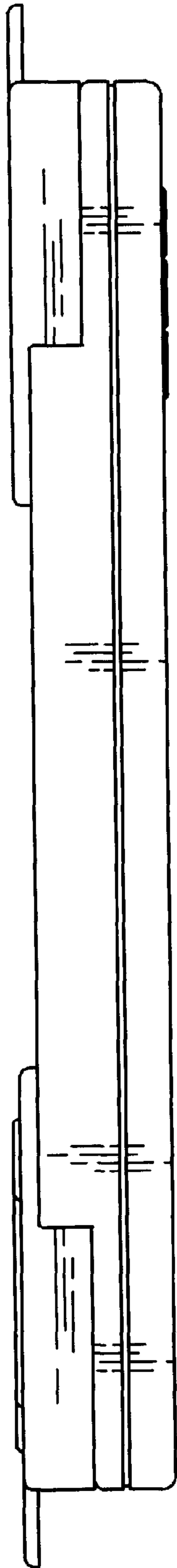

FIG. 10

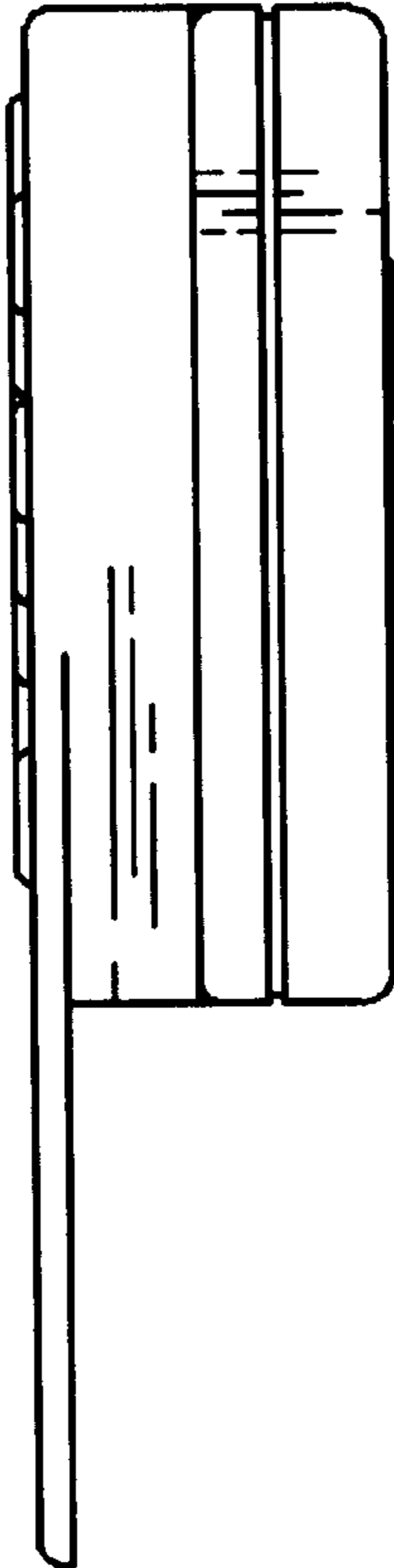

FIG. 11

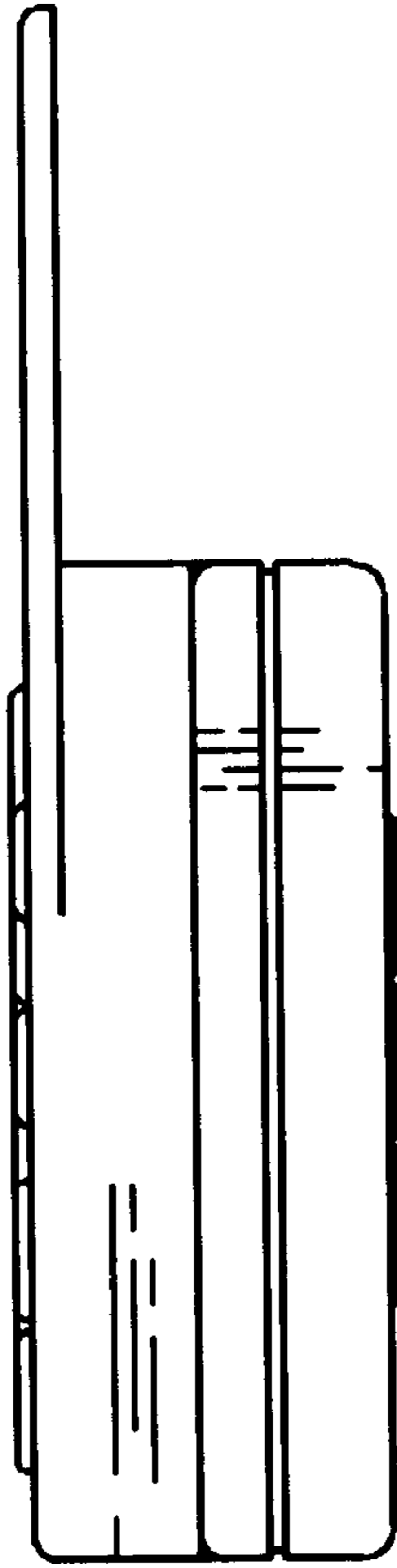

FIG. 12

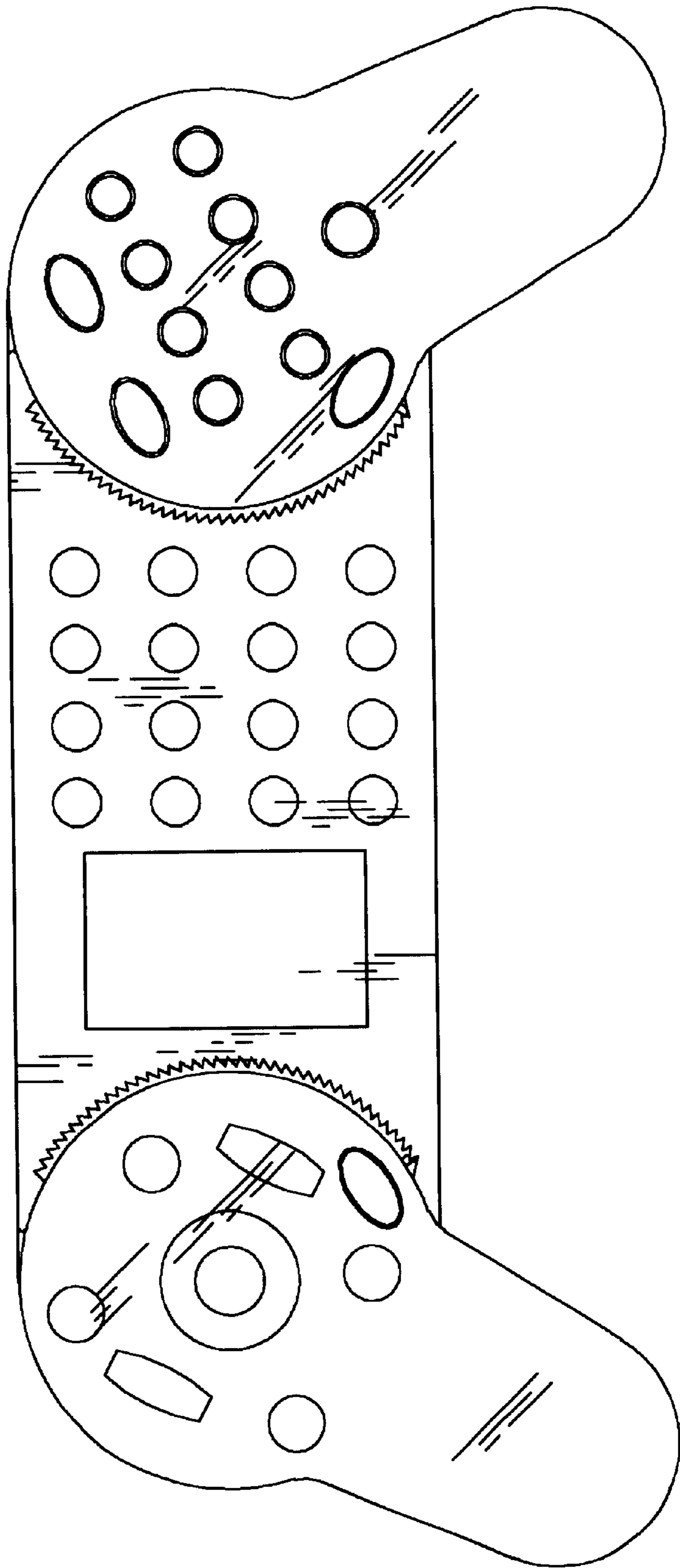

FIG. 13

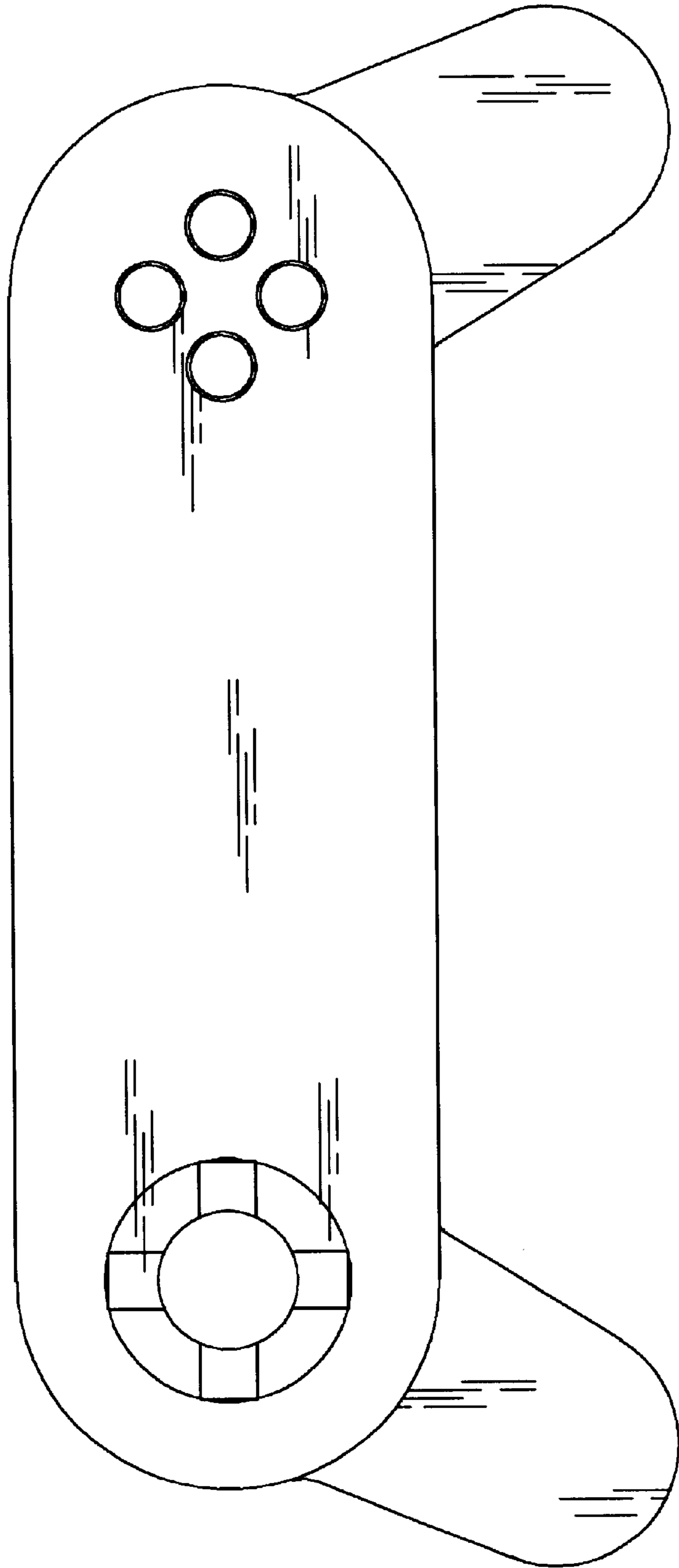

FIG. 14